

/auto2/new/u.099-0097 customer/s.c-175266

PRINT DIST. 単位: mm DIMENSIONS IN MM. DO NOT SCALE PRINT. METRIC NUMBER C-175266

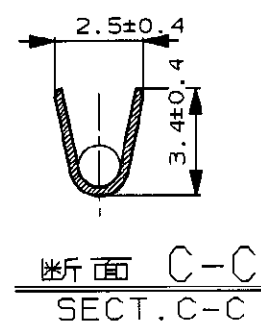
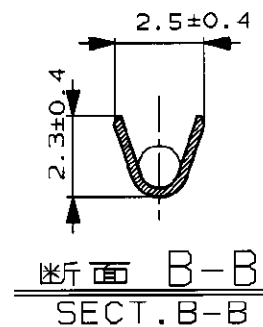
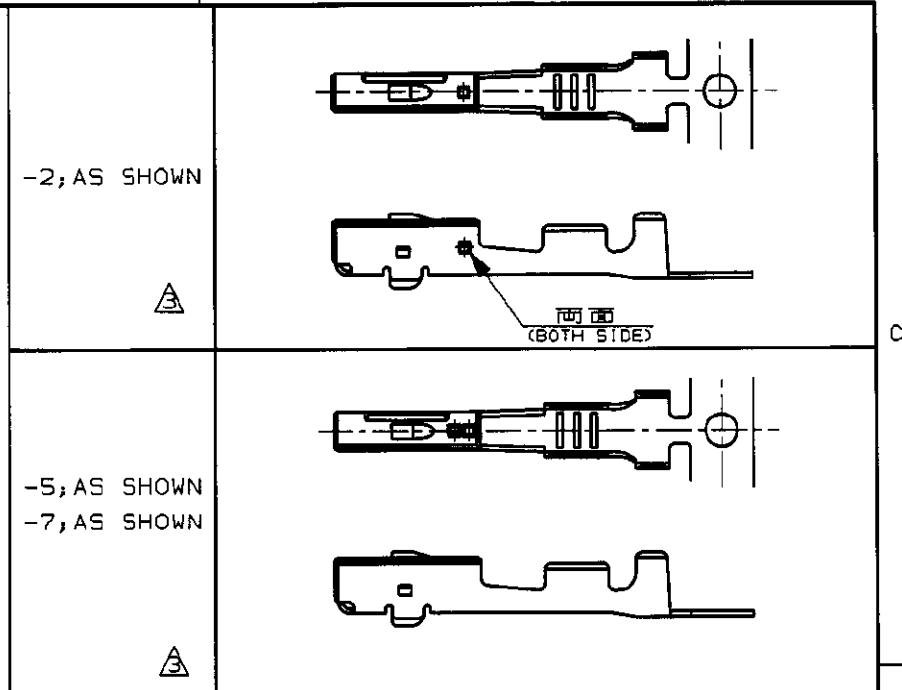
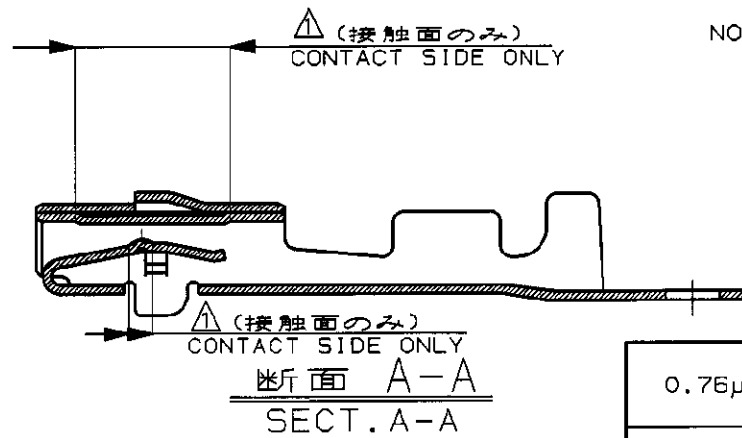
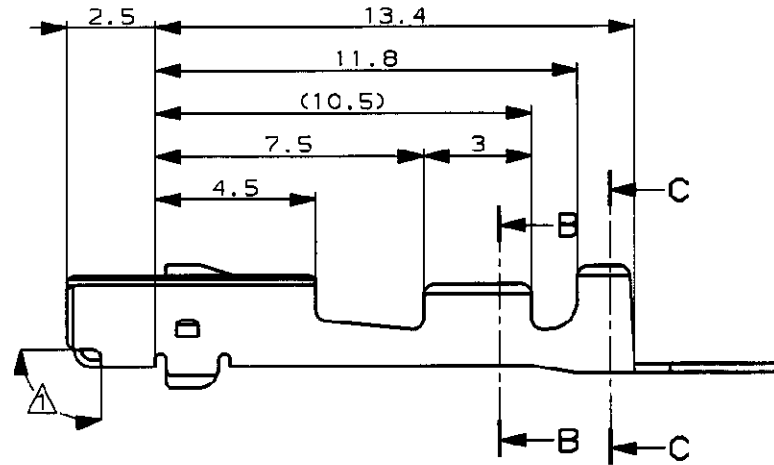
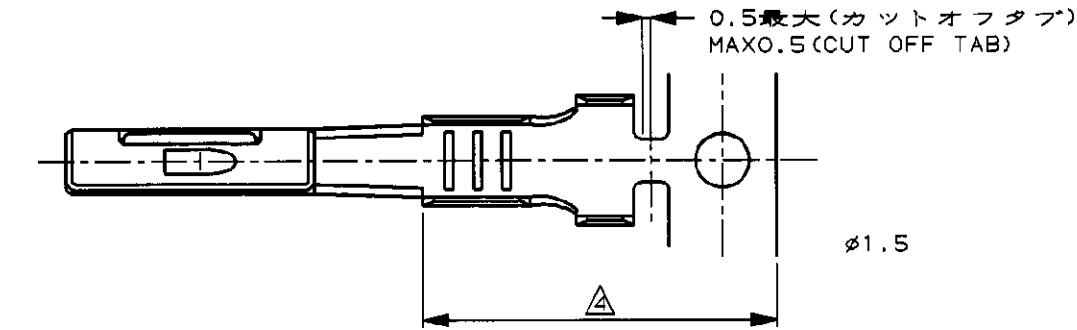
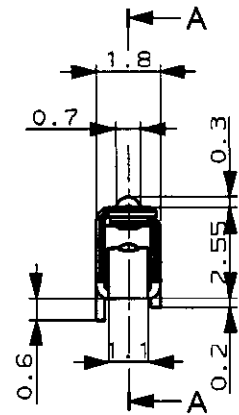

NOTE,
 1. SELECTIVE GOLD
 2. APPLICATION SPEC NO. 114-5159
 3. THE STAMP DISCERN GOLD PLATING FROM TIN PLATING
 4. SELECTIVE TIN

注,
 1. 部分金めつき
 2. 取付通用規格番号 114-5159
 3. 金めつき識別用刻印
 4. バレルすずめつき

L	REVISED (FJ00-1220-99)	KS	MT	15JUL 99
K	改訂 (FJ00-0577-98)	TK	NS	25MAR 98
J	改訂 (FJ00-1031-97)	HY	NS	29AUG 97
H	改訂 (FJ00-1905-95)	TS	KA	2/22 95
G	改訂 (FJ00-1472-94)	TS	KA	2/22 95
F	改訂 (FJ00-0975-94)	TS	KO	8/2 94
E	改訂 (FJ00-0097-94)	TS	KO	6/14 94
D	改訂 (FJ00-0153-94)	TK	MT	4/3 94
C	改訂 (FJ00-0051-93)	YK	KO	2/4 93
B	改訂 J-0212	KO	SI	7/8 91
A	再作成	KO	SI	4/25 91
LTR	変更 (REVISION RECORD)	DR	CHK	DATE

0.76μm以上	-/-	部分金めつき (SELECTIVE GOLD) バレルすずめつき (SELECTIVE TIN)	175266-7
0.76μm以上	-/-	部分金めつき (SELECTIVE GOLD)	175266-5
0.38μm以上	179418-2	部分金めつき (SELECTIVE GOLD)	175266-2
金めつき厚 (GOLD PLATING THICKNESS)	バラ端子型番 (LOOSE PIECE CONTACT P/N)	仕上げ (FINISH)	AMP型番 (PART NUMBER)

Copyright ©1990年 AMP (Japan), LTD. ALL RIGHTS RESERVED.

名称 (NAME) .040II SERIES S RECEPTACLE CONTACT
 .040II シリーズ S リセプタクル コンタクト

一般公差 (GENERAL TOLERANCE)	LDC	番号 (No.)
10以下: ±0.2 10を超え 30以下: ±0.25 30を超え 100以下: ±0.3 角: ±3°	B J	C-175266
尺度 (SCALE)	REV.	SHEET
5-1	L	1 OF 1

(CUSTOMER DRAWING) 参考 面

AMP-J REV. 10/89 FJ038205

X-ON Electronics

Largest Supplier of Electrical and Electronic Components

Click to view similar products for [Automotive Connectors](#) category:

Click to view products by [TE Connectivity](#) manufacturer:

Other Similar products are found below :

[003-018-000](#) [600858](#) [60403001](#) [60993906-B](#) [60993913-B](#) [629515004020001](#) [M83723/71R1808N L/C](#) [M902-2131](#) [M902-2161](#) [M902-2344](#)
[72.330.1035.1](#) [73.353.4028.0](#) [F118010](#) [F119300-B](#) [F132210](#) [F166900](#) [F180100](#) [F258300](#) [F258300-B](#) [F294300-B](#) [F339100](#) [F339700](#)
[F358300-B](#) [F374110](#) [F407400](#) [F412210](#) [F444110](#) [F487000](#) [F495100](#) [F500900-B](#) [F509500B-B](#) [770444-1](#) [827153-1](#) [881735-1](#)
[8N1515-32-24P](#) [9-1326729-8](#) [925467-1](#) [925474-1](#) [928905-1](#) [936398-2](#) [964562-4](#) [964731-2](#) [968782-1](#) [GT17SA-8DS-HU](#) [GT17VS-10DP-](#)
[5.2CF](#) [98315-0001](#) [98315-0010](#) [98891-1012](#) [98895-2014](#) [98936-1039](#)