

NUMBER 179974
 三角法 (3rd ANGLE PROJECTION)
 METRIC

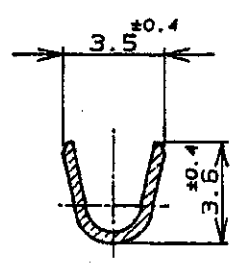

断面 "B"- "B" SECT

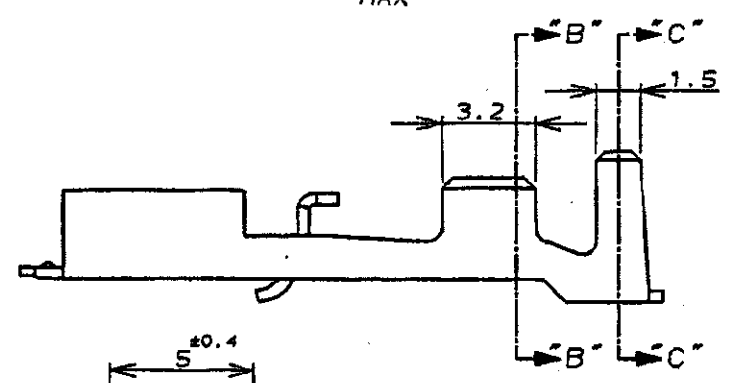
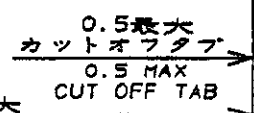
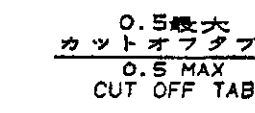
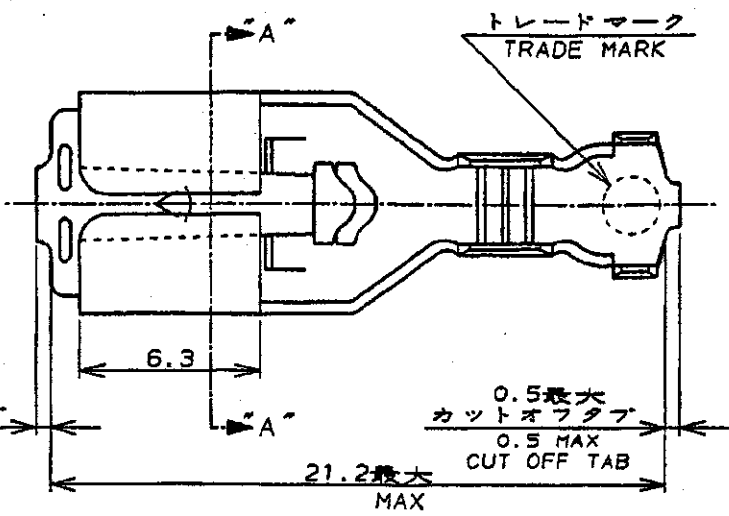
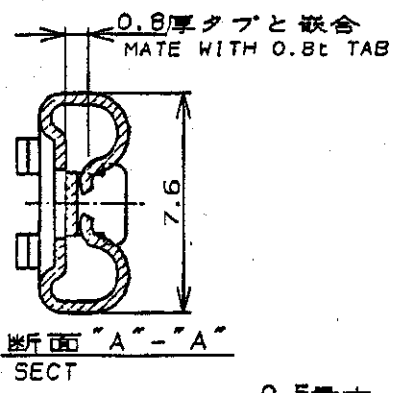
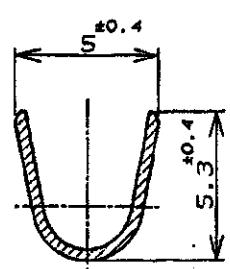

断面 "C"- "C" SECT

注記:

- 製品規格 : 108-5437
- 取付適用規格 : 114-5195
- 適用ハウジング : 179970-□
1318954-□
- 取扱説明書 : 411-5691

NOTE:

- PRODUCT SPEC : 108-5437
- APPRICATION SPEC : 114-5195
- APPRICABLE HOUSING P/N : 179970-□
1318954-□
- INSTRUCTION SHEET : 411-5691

単位: 寸法 DIMENSIONS IN MM. DO NOT SCALE PRINT

— II —	錫めっき済高耐熱銅合金 (PRE TINNED HIGH HEAT RESISTANCE COPPER ALLOY)	179974-6
179989-1	錫めっき済黄銅 (PRE TINNED BRASS)	179974-1
プラグ端子型番 (L/P No.)	材料 (MATERIAL)	型番 (P/N)



一般公差 (GENERAL TOLERANCE)	包含電線断面積 (WIRE RANGE)	絶縁外径 (INSULATION DIA.)
10以下 : ±0.2 10以上 30以下 : ±0.25 30以上 100以下 : ±0.3 角 度 : ±3°	0.76 2.09 mm ² (AWG#18-#14)	2.2-3.4 mmφ
	材料 (MATERIAL)	仕上 (FINISH)
	表参照 (SEE TABLE)	— II —

PRINT DISI	C1	REVISED PER ECO-11-005294	RK	HMR	06APR 11	尺度 (SCALE)	LOC	番号 (No.)	REV.	SHEET
	LTR	変更 (REVISION RECORD)	DR	CHK	DATE	4-1	A	J	C1	1 OF 1
	DR.	30 JUN '94	DE.	4 JUL '94		名称 (NAME)				
	CHK.	4 JUL '94	APP.	4 JUL '94		"250" SERIES POSITIVE LOCK-EX-II REC. "250" シリーズ・ポジティブロック-EX-II) セブタクル				
		N. NAGASHIMA		M. SUZUKI						
		M. SHINDO		Y. KASHIWA						

X-ON Electronics

Largest Supplier of Electrical and Electronic Components

Click to view similar products for [Terminals](#) category:

Click to view products by [TE Connectivity](#) manufacturer:

Other Similar products are found below :

[00-054007-01074-6](#) [00-054007-70206-1](#) [00-054007-70210-8](#) [00-054007-70217-7](#) [00-054007-70226-9](#) [00-054007-70228-3](#) [00-054007-70248-1](#) [00-054007-70256-6](#) [00-054007-70301-3](#) [00-054007-70316-7](#) [00-054007-49560-4](#) [00-054007-70209-2](#) [00-054007-70225-2](#) [00-054007-70227-6](#) [00-054007-70231-3](#) [00-054007-70241-2](#) [00-054007-70242-9](#) [00-054007-70244-3](#) [00-054007-70246-7](#) [00-054007-70263-4](#) [00-054007-70288-7](#) [00-054007-70290-0](#) [00-054007-70300-6](#) [00-054007-70304-4](#) [01-2065-1-0216](#) [01-2900-1-04412](#) [00581P0075](#) [600TS-10](#) [60205-1](#) [604200-1](#) [605601-1](#) [60598-1-CUT-TAPE](#) [61314-6-C](#) [61810-3](#) [61-S](#) [61-SN](#) [626-0194](#) [62-NBM-A](#) [62-SN](#) [62-SP](#) [63-S](#) [640179-1](#) [M55155/059I03](#) [M55155/079C01](#) [M55155/099H02](#) [M55155/109H01](#) [M55155/109H02](#) [M55155/12XH05](#) [M55155/16XH02](#) [M55155/29-5S](#)