

THIS DRAWING IS UNPUBLISHED. RELEASED FOR PUBLICATION
 © COPYRIGHT - By - ALL RIGHTS RESERVED.

REVISIONS					
P	LTR	DESCRIPTION	DATE	OWN	APVD
	A2	KEYING POSITION CORRECTED IN ZONE A4 & A3	27FEB2017	TJ	NG

NOTES:

- ELECTRICAL DATA: CONTACT RESISTANCE: 10 mOhm MAX
 INSULATION RESISTANCE: 100 MOhm MIN at 500VDC
 CURRENT RATING: 5 AMPS (FOR 3, 4 AND 5 POSITIONS) AND 2 AMPS (FOR 8 POSITIONS)
 BREAKDOWN VOLTAGE: 500 VAC MIN PER MINUTE
- ENVIRONMENTAL: OPERATING TEMPERATURE: -25°C TO +90°C
 SEALING REQUIREMENTS: IP67
- PACKAGING: 107-3334
- SEAL FOR CABLE OD: ϕ 4.5mm - ϕ 6.5mm
- FOR TECHNICAL DATA REFER TO YOUR LOCAL TE CONNECTIVITY SALES OFFICE.
- ALL DIMENSIONS ARE FOR NOMINAL REFERENCE ONLY UNLESS OTHERWISE STATED.

ITEM	DESCRIPTION	MATERIAL	FINISH/COLOUR	QUANTITY / ITEM		
				-1	-2	-3
1	CONNECTOR HOUSING	GF NYLON	BLACK	1	1	1
2	GASKET	SILICONE	BLACK	1	1	1
3	CONNECTOR BODY	GF NYLON	BLACK	1	1	1
4	SEALING NUT	GF NYLON	BLACK	1	1	1
5	SEAL	EPDM	BLACK	1	1	1
6	PIN CONTACT	BRASS	0.15 μ m GOLD OVER NICKEL	3	4	5
7	SCREW NUT	GF NYLON	BLACK	1	1	1

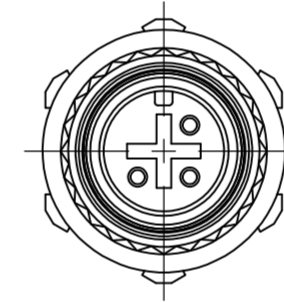
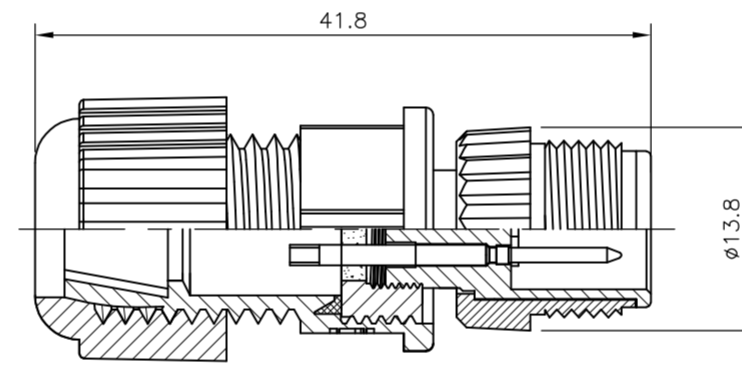
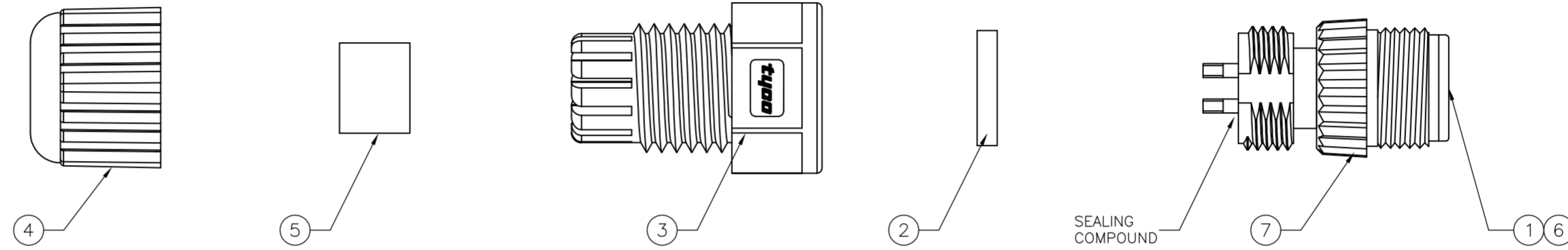

1838277-1
PIN ASSIGNMENTS
FRONT VIEW

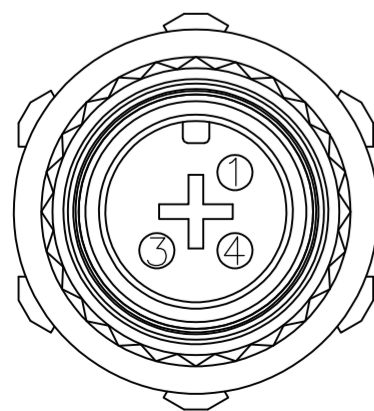

1838277-2
PIN ASSIGNMENTS
FRONT VIEW

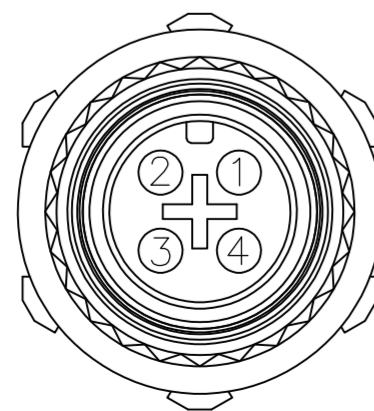

1838277-3
PIN ASSIGNMENTS
FRONT VIEW

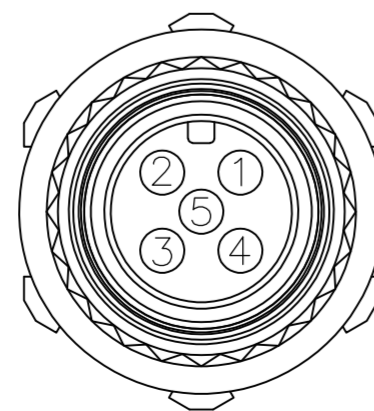

1838277-4
PIN ASSIGNMENTS
FRONT VIEW

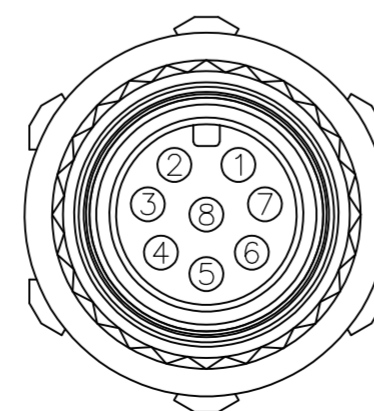

M12 PLASTIC FIELD SERVICEABLE CONNECTOR, MALE PIN, SOLDER TYPE	8	1838277-4
M12 PLASTIC FIELD SERVICEABLE CONNECTOR, MALE PIN, SOLDER TYPE	5	1838277-3
M12 PLASTIC FIELD SERVICEABLE CONNECTOR, MALE PIN, SOLDER TYPE	4	1838277-2
M12 PLASTIC FIELD SERVICEABLE CONNECTOR, MALE PIN, SOLDER TYPE	3	1838277-1
DESCRIPTION	NO. OF POS	PART NUMBER

THIS DRAWING IS A CONTROLLED DOCUMENT.		DWN A.Morey 14MAR06	TE Connectivity	
DIMENSIONS: mm		CHK F.Wheeler-King 12APR06	NAME M12 PLASTIC FIELD SERVICEABLE CONNECTOR, MALE PIN, SOLDER TYPE	
TOLERANCES UNLESS OTHERWISE SPECIFIED		APVD F.Wheeler-King 12APR06	DRAWING NO 00779	
0 PLC ± -		PRODUCT SPEC	RESTRICTED TO	
1 PLC ± -		APPLICATION SPEC	SIZE A2	
2 PLC ± -		WEIGHT 0	CAGE CODE 00779	
3 PLC ± -		FINISH REFER BOM TABLE	DRAWING NO 1838277	
4 PLC ± -		MATERIAL REFER BOM TABLE	SCALE NTS	
ANGLES ± -		CUSTOMER DRAWING		SHEET 1 OF 1
FINISH REFER BOM TABLE		REV A2		

X-ON Electronics

Largest Supplier of Electrical and Electronic Components

Click to view similar products for [Circular Metric Connectors](#) category:

Click to view products by [TE Connectivity](#) manufacturer:

Other Similar products are found below :

[600X518037X](#) [6STD15PCR99B70A](#) [8R4000A16M020](#) [8R5000A16M005](#) [1200910002](#) [1203580030](#) [1200910008](#) [1200910011](#) [1300140094](#)
[130203-0054](#) [1300140026](#) [1300150099](#) [RF-12S1N8A90DU](#) [1-3637-600-5205](#) [1612618](#) [21036836414](#) [8R4006A16M010](#) [8R5006A18A120](#)
[1604232](#) [1R3006A20M005](#) [RF-12P1N8A80DU](#) [RF-12P1N8A90DU](#) [41-40011](#) [42-01015](#) [4-22279-4](#) [4-22281-1](#) [4-22284-9](#) [43-00113](#) [43-](#)
[01088](#) [43-01203](#) [41-40013](#) [42-00008](#) [43-00343](#) [43-01032](#) [43-01162](#) [43-10000](#) [600X518050X](#) [SACC-DSI-FS-5P-PG9-L180 SC](#)
[8R5006A16M020](#) [8R5006A16M005](#) [8R4000A16M010](#) [6-22279-3](#) [1605332](#) [N03FA03144](#) [1300140077](#) [43-01338](#) [XS2RD4265](#) [RSC 4/9](#)
[XS2R-D426-1](#) [XS8A-0441](#)