

THIS DRAWING IS UNPUBLISHED. RELEASED FOR PUBLICATION
 © COPYRIGHT - BY TYCO ELECTRONICS CORPORATION. ALL RIGHTS RESERVED.

LOC		DIST		REVISIONS			
P	LTR	DESCRIPTION	DATE	DWN	APVD		
	C	REVISED PER ECR-18-012809	15AUG2018	FL	HL		

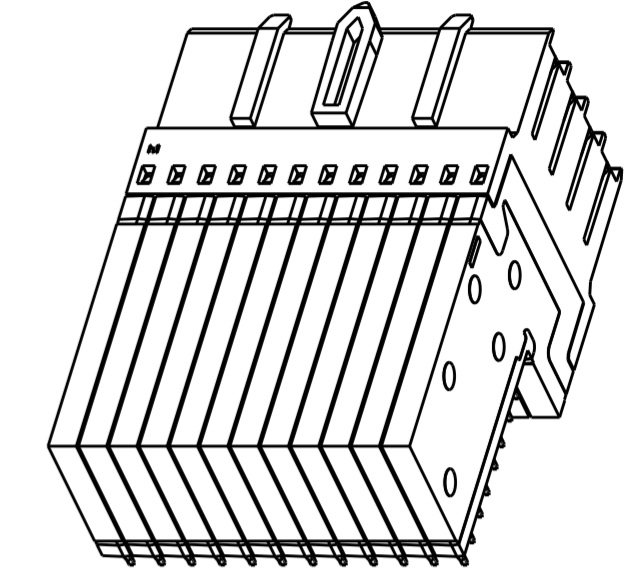

SCALE 3:1

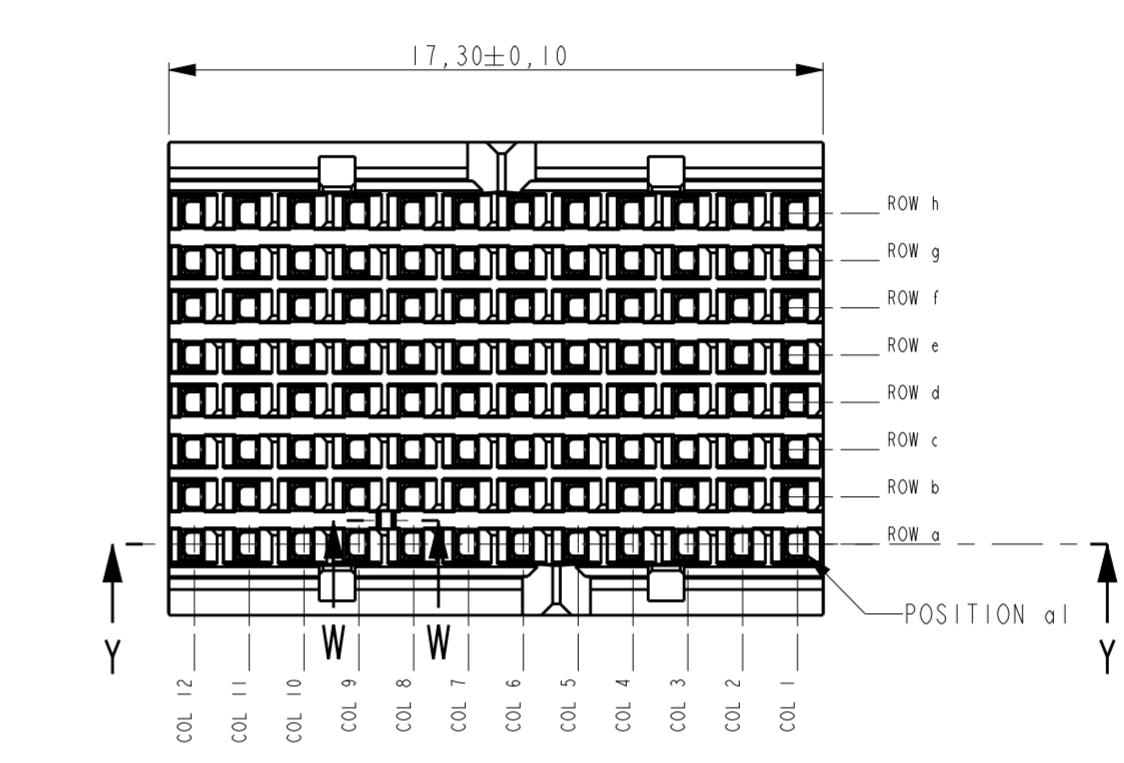
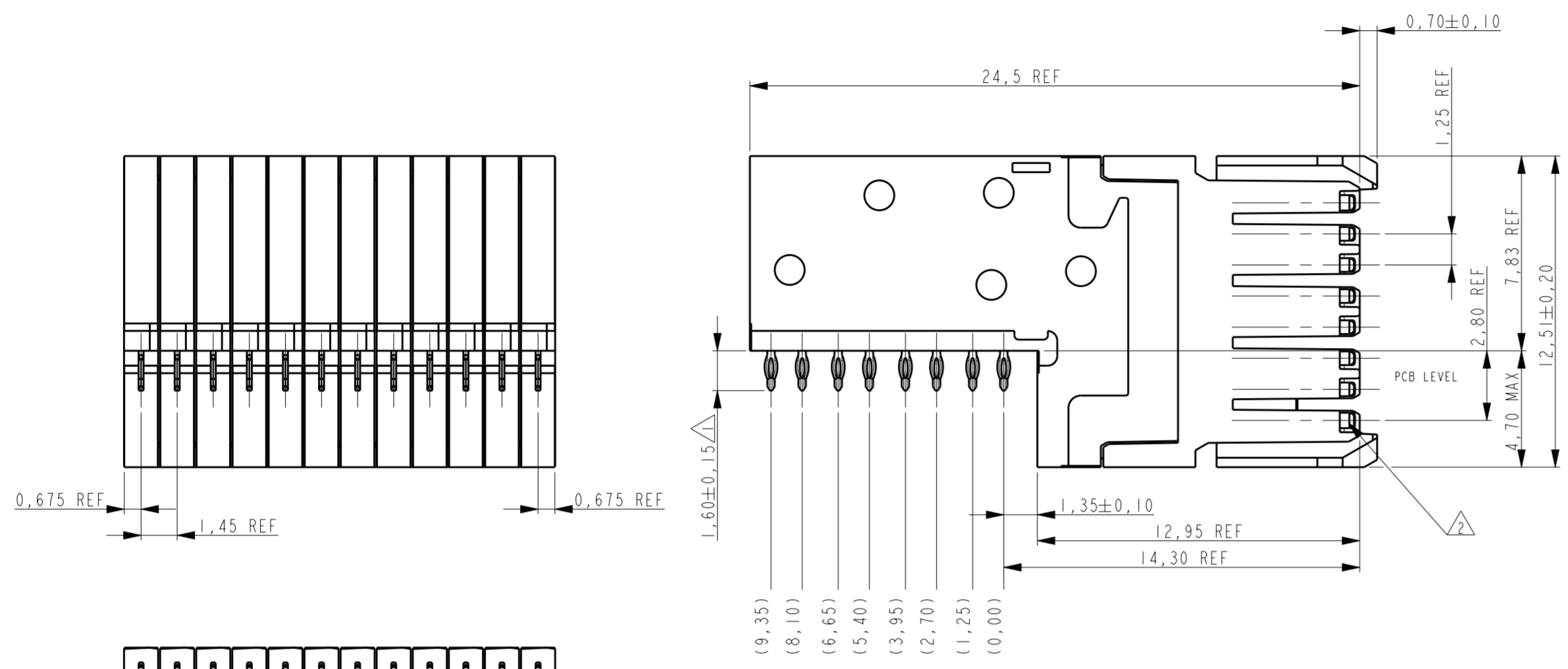
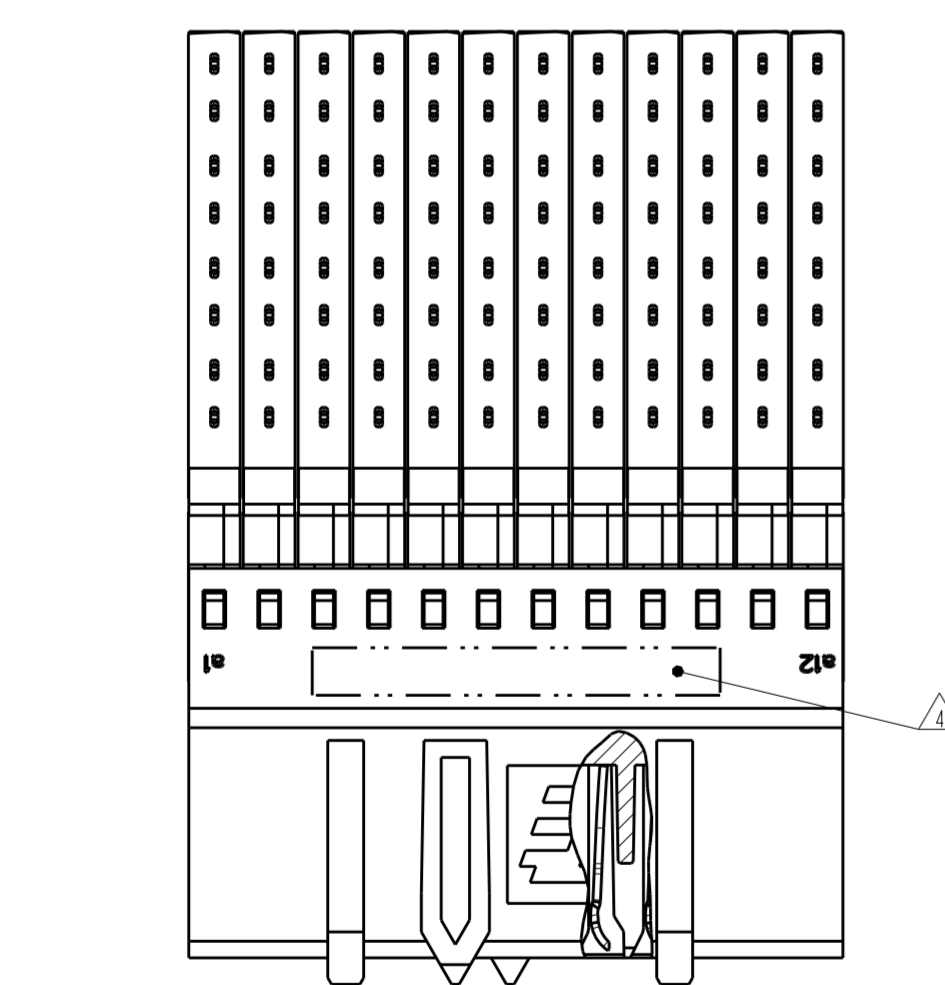

SECTION W-W
(KEY POSITION)

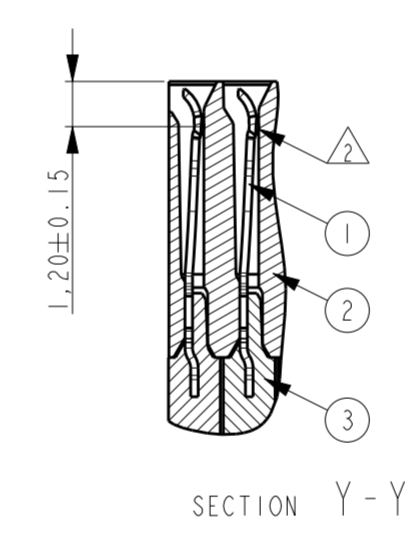

SECTION Y-Y

NOTES:

- 1 PLATING: 0,5µm MIN. TIN OVER NICKEL.
- 2 PLATING:

PARTNUMBER	PERFORMANCE LEVEL
1857657-1	PERFORMANCE LEVEL 1: CONNECTOR TESTED AND QUALIFIED AGAINST TELCORDIA GR-1217-CORE QUALITY LEVEL III: UNCONTROLLED ENVIRONMENT APPLICATIONS. SEE PRODUCT SPEC 108-19353
1857657-2	PERFORMANCE LEVEL 2: CONFORMS TO ALL TESTING ACCORDING PRODUCT SPEC 108-19320, -250 MATING CYCLES, 4 DAYS MIXED GAS TEST PER IEC 60068-2-60 METHOD 1

- 3 CONSULT APPLICATION SPEC OR CONTACT TE CONNECTIVITY FOR PERMISSIBLE CONTACT ASSIGNMENTS.
- 4 CONNECTOR MARKED WITH PARTNUMBER AND DATE CODE. DATE CODE DEFINITION: YYWW.

3	OVERMOLD	LCP 30% GF NATURAL
2	HOUSING	LCP 30% GF NATURAL
1	CONTACT	COPPER ALLOY
ITEM NO.	DESCRIPTION	MATERIAL

THIS DRAWING IS A CONTROLLED DOCUMENT.		DWN J.V.D. HELLDEN 30 OCT 2006	TE Connectivity	
DIMENSIONS: mm		CHK J. TUIN 30 OCT 2006		
TOLERANCES UNLESS OTHERWISE SPECIFIED:		APVD J. BROEKSTEEG 30 OCT 2006	NAME FEMALE CONNECTOR Z-PACK Slim UHD High Speed	
0 PLC ±		PRODUCT SPEC SEE NOTE 1	SIZE A2	
1 PLC ±		APPLICATION SPEC 114-19106	CAGE CODE 00779	DRAWING NO. 1857657
2 PLC ±		WEIGHT -	RESTRICTED TO	
3 PLC ±		CUSTOMER DRAWING	SCALE 5:1 SHEET 1 OF 2 REV C	
4 PLC ±				
ANGLES ±				
FINISH				

THIS DRAWING IS UNPUBLISHED. RELEASED FOR PUBLICATION
 © COPYRIGHT - BY TYCO ELECTRONICS CORPORATION. ALL RIGHTS RESERVED.

LOC	DIST	REVISIONS			
P	LTR	DESCRIPTION	DATE	DWN	APVD
H	-	SEE SHEET 1	-	-	-

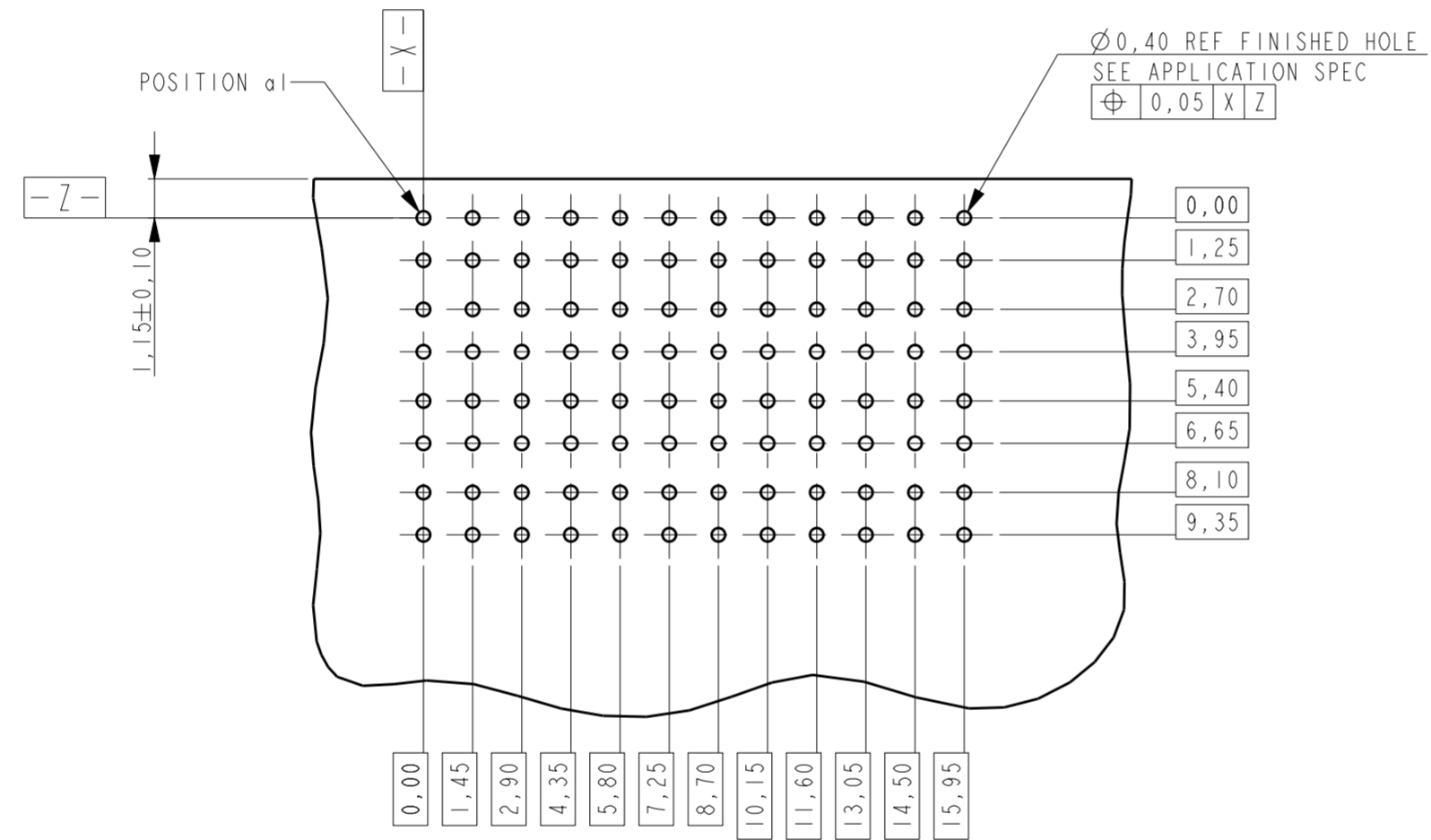

BOARD THICKNESS 1,2 MIN

RECOMMENDED PCB LAYOUT
(COMPONENT SIDE SHOWN)

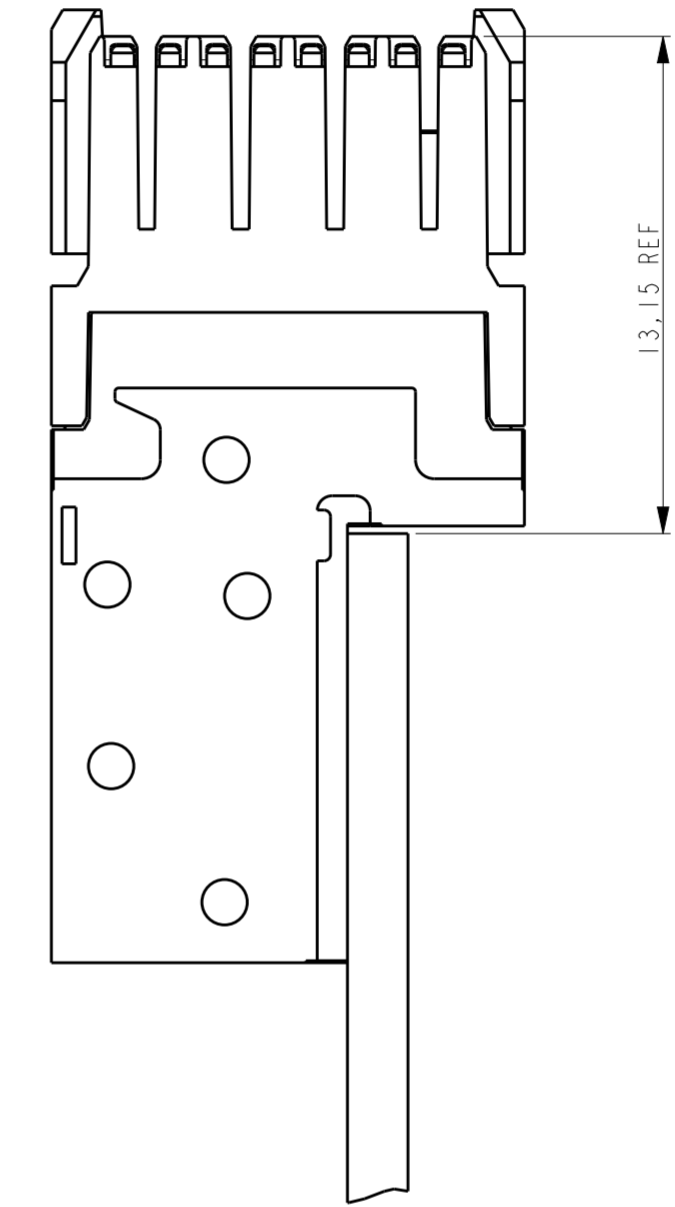

THIS DRAWING IS A CONTROLLED DOCUMENT.		DWN J.V.D. HEIJDEN 30 OCT 2006	TE Connectivity	
DIMENSIONS: mm		CHK J.TWIN 30 OCT 2006		
TOLERANCES UNLESS OTHERWISE SPECIFIED:		APVD J.BROEKSTEEG 30 OCT 2006	NAME FEMALE CONNECTOR Z-PACK Slim UHD High Speed	
0 PLC ± 1 PLC ± 2 PLC ± 3 PLC ± 4 PLC ± ANGLES ± FINISH ±		PRODUCT SPEC SEE NOTE 2 APPLICATION SPEC 114-19106	SIZE A2	CAGE CODE 00779
MATERIAL		WEIGHT	DRAWING NO C-1857657	RESTRICTED TO
		CUSTOMER DRAWING	SCALE 5:1	SHEET 2 OF 2
				REV C

X-ON Electronics

Largest Supplier of Electrical and Electronic Components

Click to view similar products for [High Speed/Modular Connectors](#) category:

Click to view products by [TE Connectivity](#) manufacturer:

Other Similar products are found below :

[2332816-1](#) [89006-1137LF](#) [650827-1](#) [65762-001LF](#) [73474-201LF](#) [74040-1346](#) [74075-0267](#) [1410191-1](#) [1410337-1](#) [1410368-3](#) [1410964-2](#)
[1410367-3](#) [1410971-4](#) [1467833-1](#) [2000877-1](#) [2000878-1](#) [2041314-1](#) [2065387-1](#) [2187307-1](#) [2187462-1](#) [91290-101LF](#) [163P](#) [1934290-1](#)
[2000875-1](#) [2065917-1](#) [2102736-2](#) [FSR-40](#) [2169868-2](#) [22354-8](#) [437-5040-000](#) [5-1393565-0](#) [532449-3](#) [532803-2](#) [34745-0001](#) [1-1393708-5](#)
[73774-1000](#) [532939-1](#) [5-531355-3](#) [85838-180LF](#) [HM1S43TRR460H6PLF](#) [0760205010](#) [0782341022](#) [1-966831-4](#) [3-1469268-7](#) [77427-121LF](#)
[74748-102LF](#) [10009542-001LF](#) [73983-A001LF](#) [10041743-101LF](#) [10066670-100002LF](#)