

THIS DRAWING IS UNPUBLISHED.

RELEASED FOR PUBLICATION

REVISIONS

変更

© COPYRIGHT - TE Connectivity Ltd.

ALL RIGHTS RESERVED.

P	LTR	DESCRIPTION	DATE	DWN	APVD
	D	REVISED PER ECR-19-008563	22DEC2020	SC	D.Z

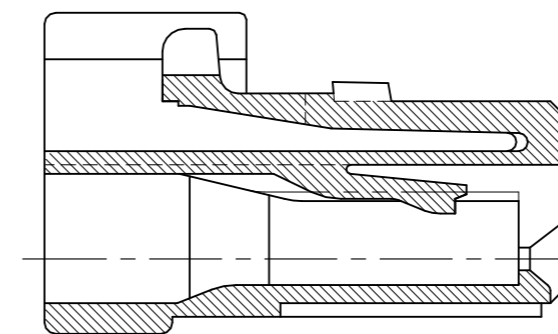
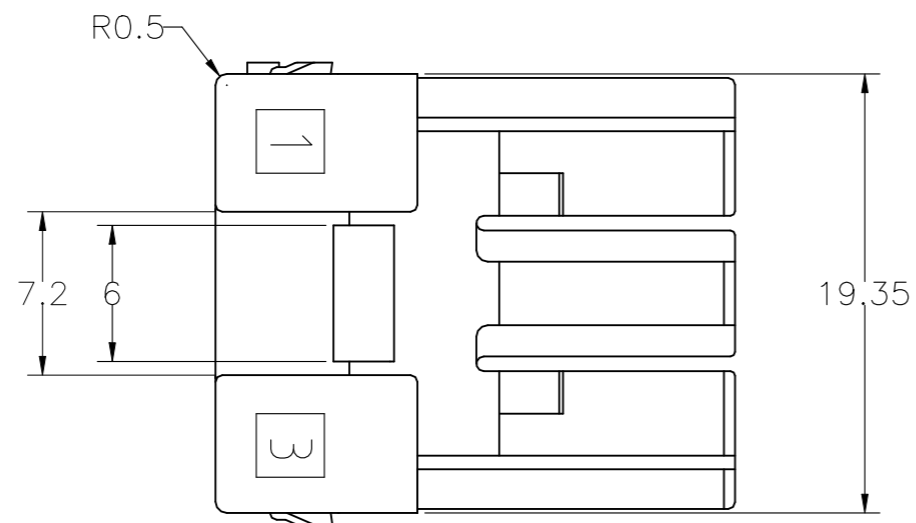

断面 A-A
SECT A-A

TYPE OF KEYING

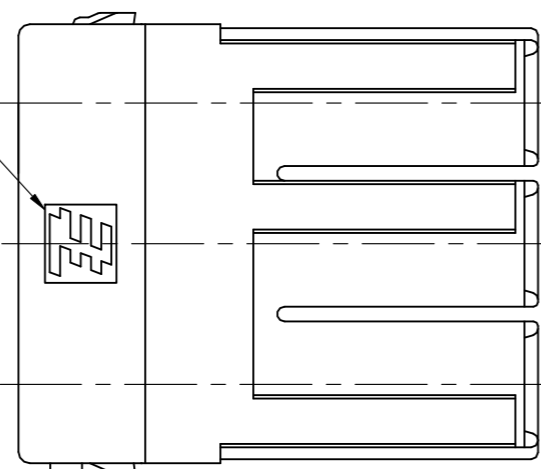
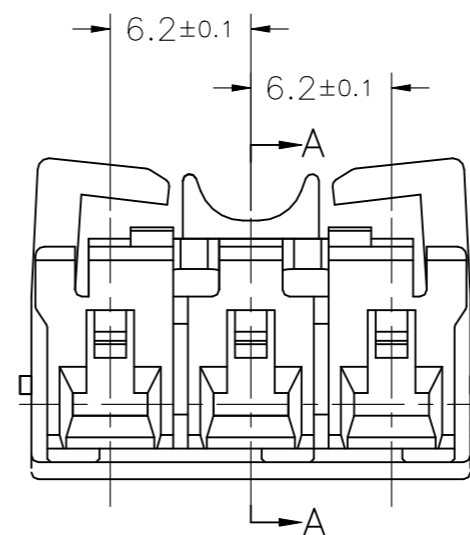
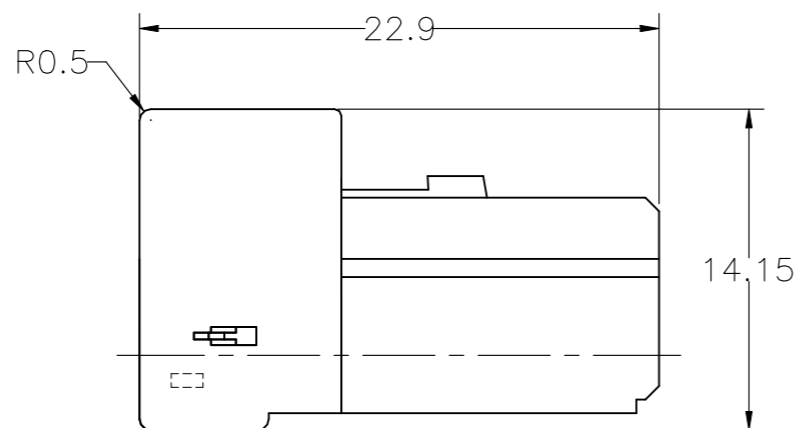
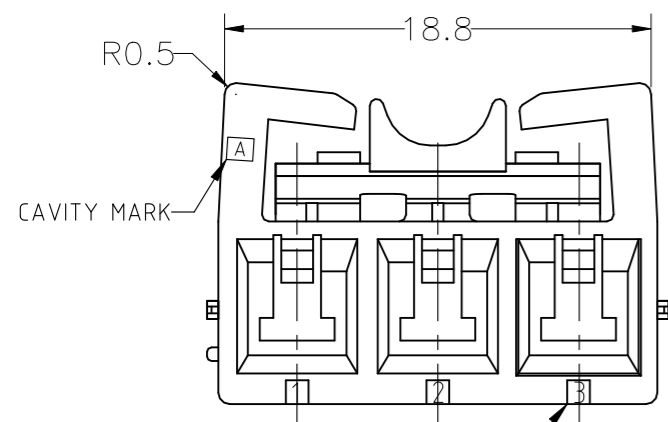
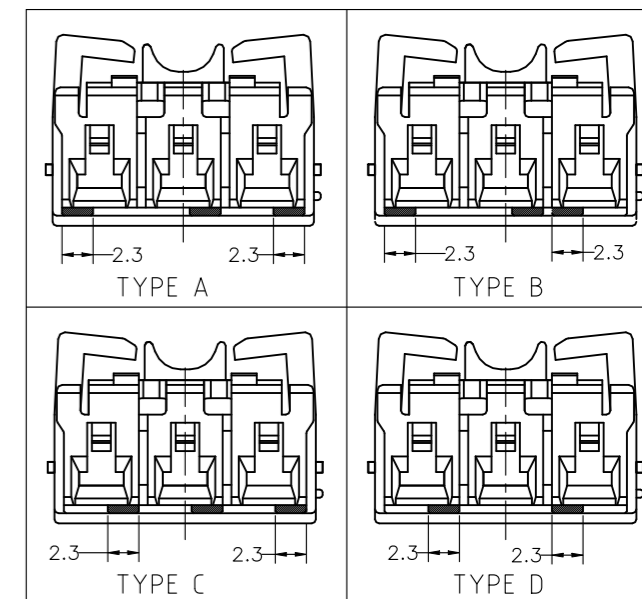

- 注) 1.一般公差:±0.25
 2.材料: 66ナイロン ガラス無(UL94V-0)
 3.適用リセコンタクト製品型番: 1746971-1
 1746972-1
 △かん合相手製品型番
 キャップハウジング: TABLE参照のこと
 タブコンタクト: 1746973-1
 1746974-1

- NOTES)
 1.GENERAL TOLERANCE : ±0.25
 2.MATERIAL : 66 NYLON NON-GLASS FILLED (UL94V-0)
 3.APPLICABLE RECEPTACLE P/N :1746971-1
 1746972-1
 △ MATING CONN. P/N
 CAP HOUSING : SEE TABLE
 TAB CONTACT : 1746973-1
 1746974-1
 △ PRELIMINARY NOT FOR PRODUCTION

1-1746978-1 △	A	NATURAL	1-1871867-1 △
1746978-1	A	NATURAL	1871867-1
△ MATING HSG P/N	KEYING TYPE	COLOR	P/N

THIS DRAWING IS A CONTROLLED DOCUMENT.		DWN A.HIROTA 6SEP2005	STE TE Connectivity	
DIMENSIONS: 単位: 耗 mm		CHK N.YAMASAKI 6SEP2005		
TOLERANCES UNLESS OTHERWISE SPECIFIED: 一般公差		APVD N.YAMASAKI 6SEP2005	NAME 名称 GRACE INERTIA CONNECTOR 6.2MM PITCH 3POS PLUG HOUSING	
0 PLC ± - 1 PLC ± - 2 PLC ± - 3 PLC ± - 4 PLC ± - ANGLES ± -		PRODUCT SPEC 製品規格 108-5979	DRAWING NO 番号 A3 00779 C-1871867	
MATERIAL 材料 66NYLON(UL94V-0)		FINISH 仕上 -	APPLICATION SPEC 取付適用規格 114-5356	RESTRICTED TO -
		WEIGHT -	SCALE 尺度 3:1	SHEET 1 OF 2
		CUSTOMER DRAWING		REV D

THIS DRAWING IS UNPUBLISHED.

RELEASED FOR PUBLICATION

REVISIONS

© COPYRIGHT - TE Connectivity Ltd.

ALL RIGHTS RESERVED.

P	LTR	DESCRIPTION	DATE	DWN	APVD
-	-	SEE SHEET 1	-	-	-

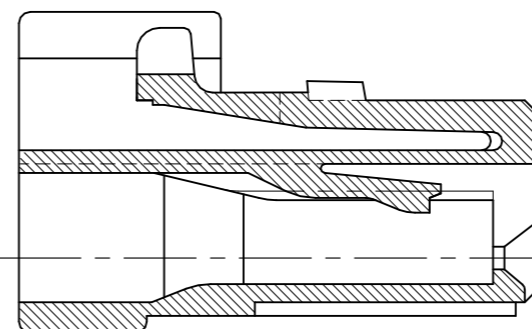
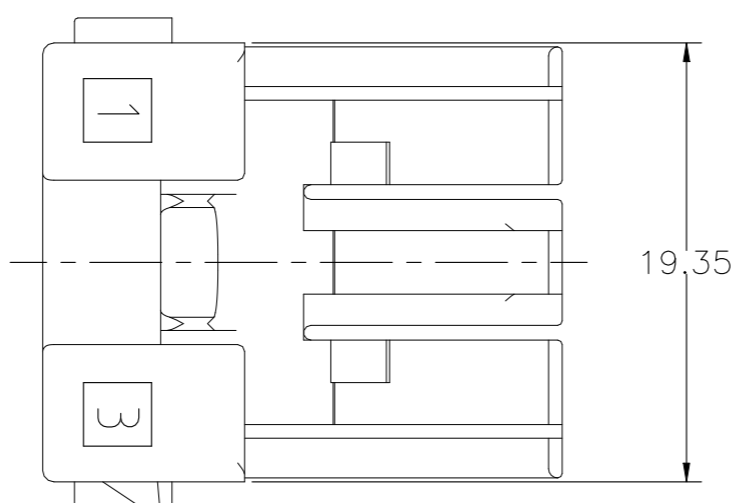

断面 A-A
SECT A-A

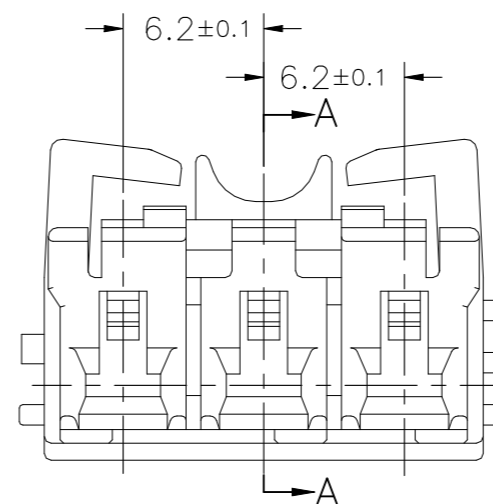
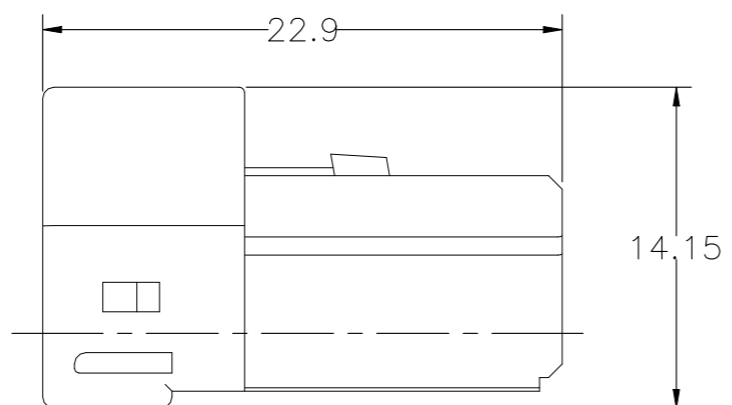

TYPE OF KEYING

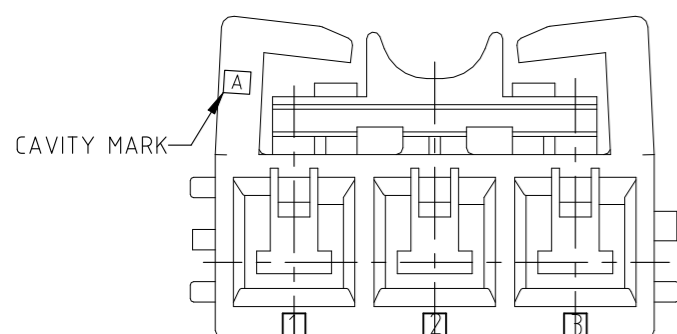
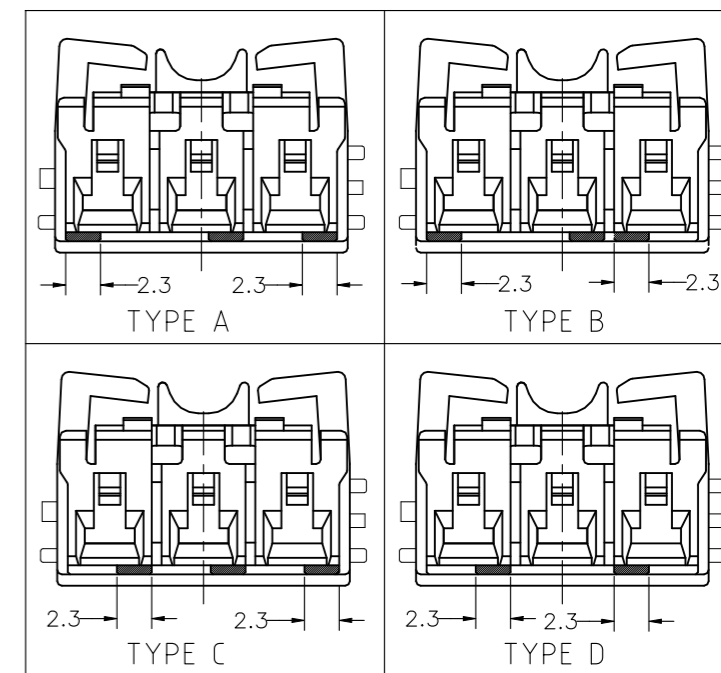

回路番号
CIRCUIT NO.

TRADE MARK

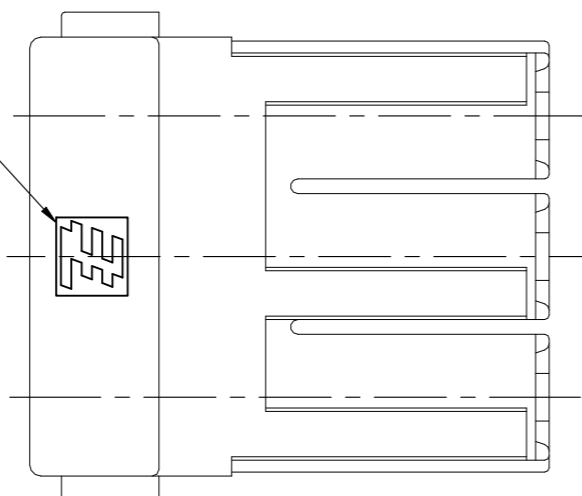

NOTES)
△ MATING TPA P/N: 1-2232564-1

4-1746978-1	A	NATURAL	4-1871867-1
△ △ MATING HSG P/N	KEYING TYPE	COLOR	△ P/N

THIS DRAWING IS A CONTROLLED DOCUMENT.		DWN A.HIROTA 6SEP2005	STE TE Connectivity	
DIMENSIONS: 単位: 耗 mm		CHK N.YAMASAKI 6SEP2005		
TOLERANCES UNLESS OTHERWISE SPECIFIED: 一般公差		APVD N.YAMASAKI 6SEP2005	NAME 名称 GRACE INERTIA CONNECTOR 6.2MM PITCH 3POS PLUG HOUSING	
0 PLC ± - 1 PLC ± - 2 PLC ± - 3 PLC ± - 4 PLC ± - ANGLES ± -		PRODUCT SPEC 製品規格 108-5979	DRAWING NO 番号 A3 00779 C-1871867	
MATERIAL 材料 66NYLON(UL94V-0)		FINISH 仕上 -	APPLICATION SPEC 取付適用規格 114-5356	RESTRICTED TO -
		WEIGHT -	SCALE 尺度 3:1	SHEET 2 OF 2
		CUSTOMER DRAWING		REV C3

X-ON Electronics

Largest Supplier of Electrical and Electronic Components

Click to view similar products for [Power to the Board](#) category:

Click to view products by [TE Connectivity](#) manufacturer:

Other Similar products are found below :

[6450171-4](#) [6450552-7](#) [6600323-8](#) [6643429-1](#) [6646040-2](#) [6651939-1](#) [6766604-1](#) [120959-1](#) [1393557-2](#) [1393532-2](#) [1393532-3](#) [1393532-4](#)
[1393557-1](#) [1600812-5](#) [1-6450861-2](#) [1744132-7](#) [1761122-1](#) [1766250-1](#) [1892109-1](#) [2-6450860-5](#) [2-6450870-0](#) [1-6450161-4](#) [1-6450850-6](#) [1-](#)
[6450869-6](#) [1645526-2](#) [1-6600130-0](#) [2005243-2](#) [377-0020-11130](#) [TE34-12-16P-F0](#) [51700-10201602AALF](#) [5-6450830-6](#) [5646956-4](#) [377-](#)
[0080-11131A](#) [4-6450830-9](#) [4-6600333-3](#) [10125416-4050LF](#) [10130248-005LF](#) [6600320-3](#) [3-6450860-5](#) [1888123-2](#) [6450166-1](#) [6643978-1](#)
[6766605-1](#) [701-15-02109](#) [N11444](#) [6651938-1](#) [6450810-7](#) [46437-1112](#) [1-1589677-8](#) [5646956-5](#)