

LOC	DIST	REVISIONS					
		P	LTN	DESCRIPTION	DATE	DWN	APVD
ES	00	B1		REV PER ECR-13-004638	20MAR2013	ML	SZ

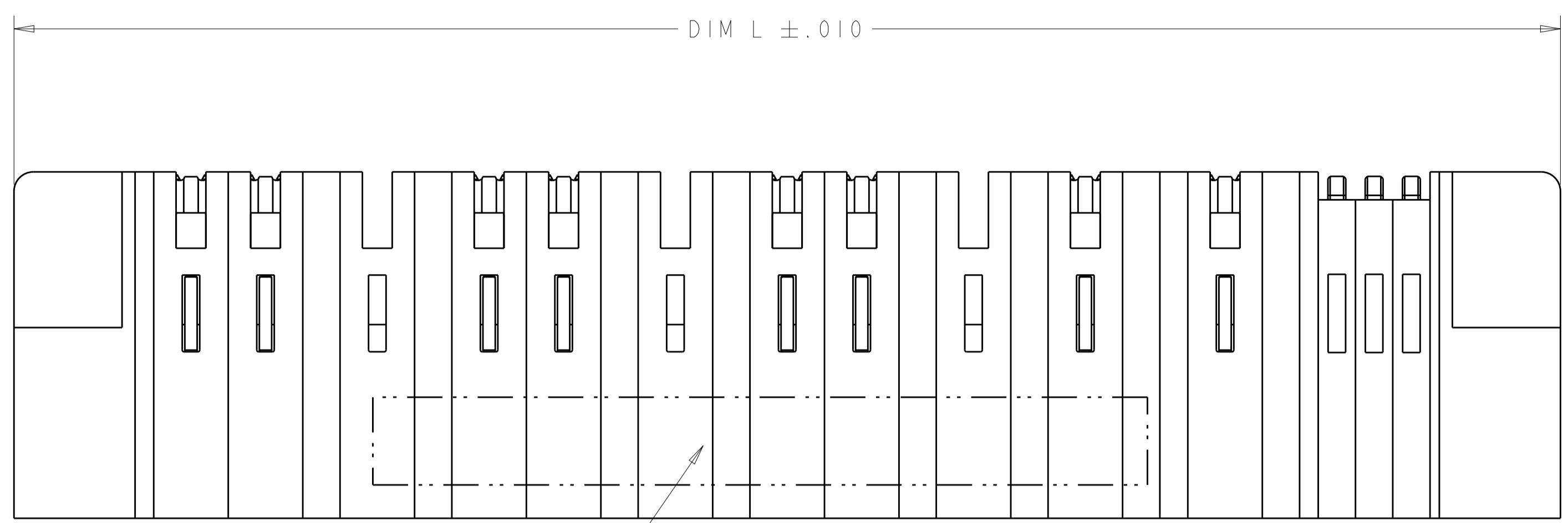

- 1 PART NUMBER, AND DATE CODE MARKED IN AREA SHOWN.
- 2 MATERIAL:  
HOUSING - GLASS FILLED HIGH TEMP THERMO PLASTIC, UL94 V-0  
SIGNAL CONTACT - COPPER ALLOY  
POWER CONTACT - HIGH CONDUCTIVITY COPPER ALLOY
- 3 CONTACT PLATING: NOBLE METAL PLATING ON CONTACT FUNCTIONAL AREA OF SIGNAL AND POWER CONTACTS.
- 4 MECHANICAL CONNECTOR KEEP OUT ZONE.
- 5 DATUM AND BASIC DIMENSIONS ESTABLISHED BY CUSTOMER.
- 6 PCB - ALL HOLE DIAMETERS ARE FINISHED HOLE SIZES.
- 7 PCB - .0453±.0010 DRILLED HOLES PLATED WITH .0003 MIN Sn OVER .001 TO .003 Cu PLATING TO ACHIEVE A .040 HOLE.
- 8 VARIABLE DIMENSION SEE SHEET 2.

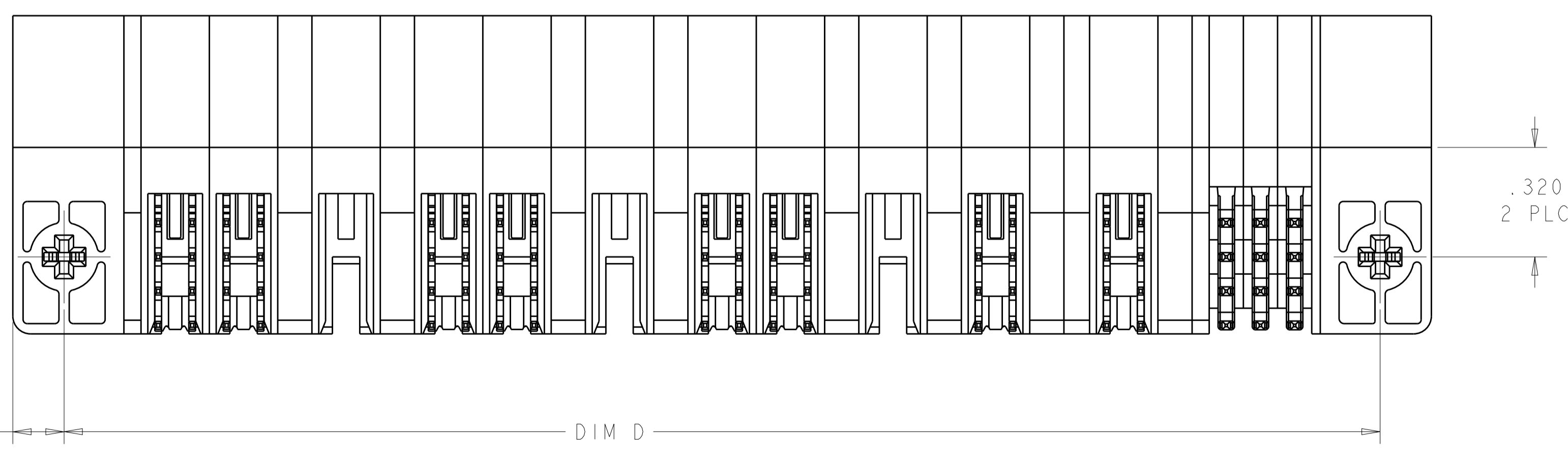
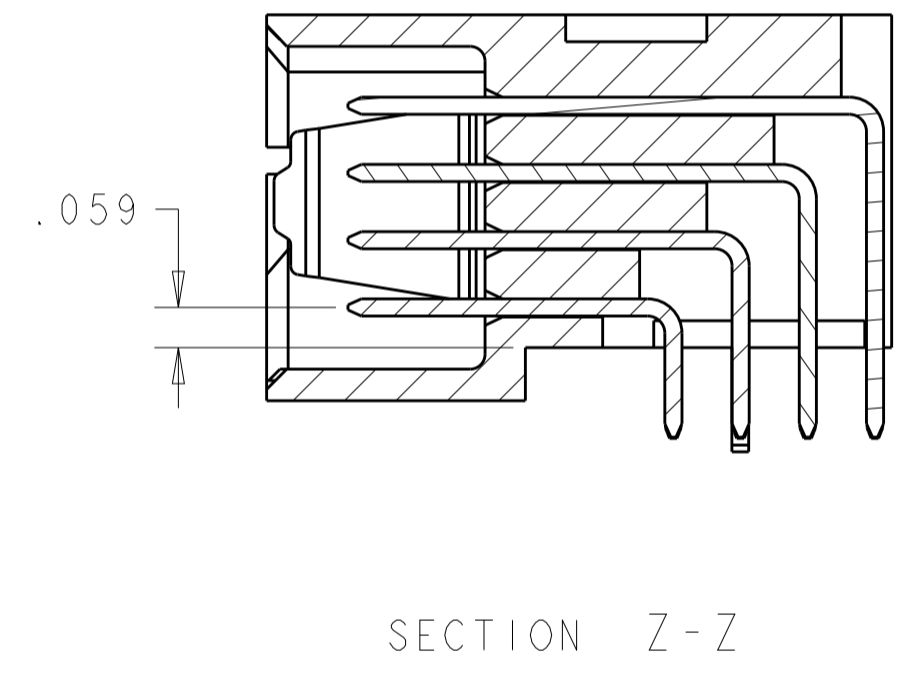
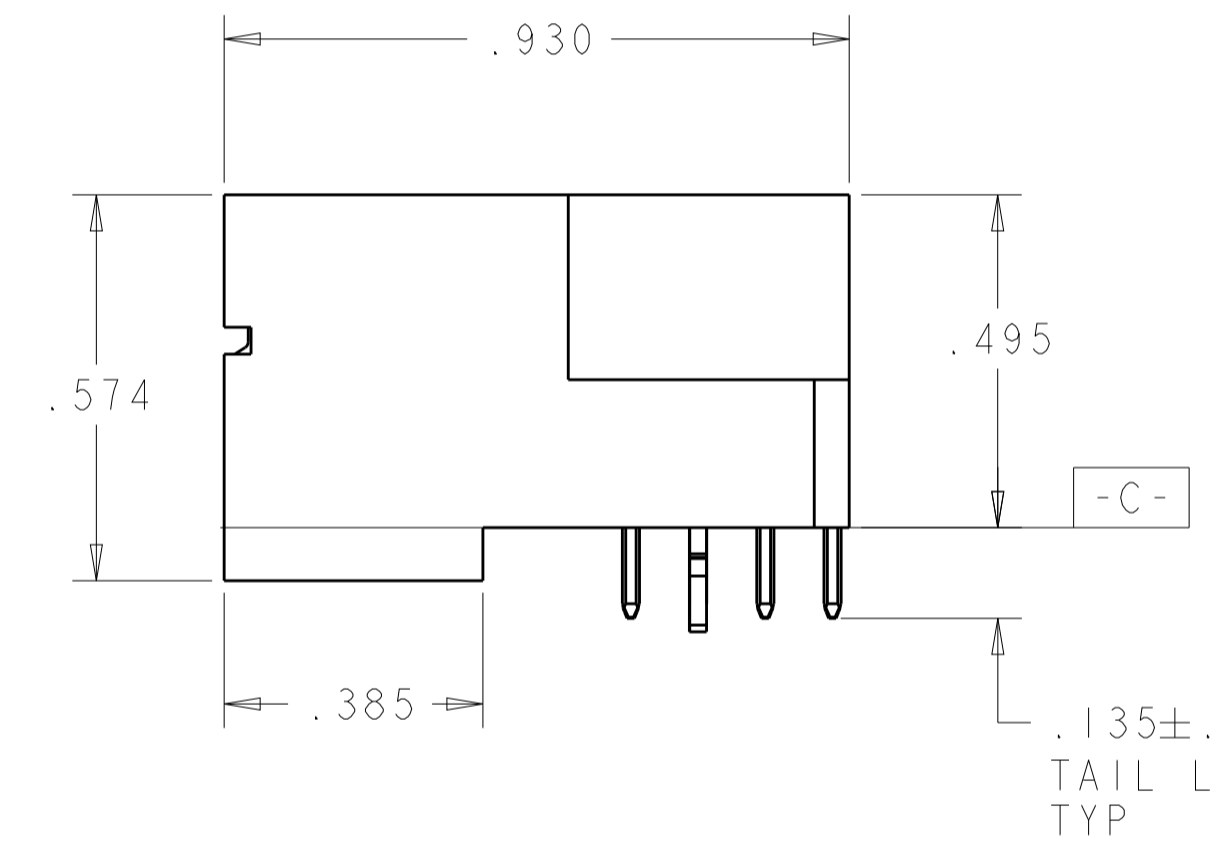
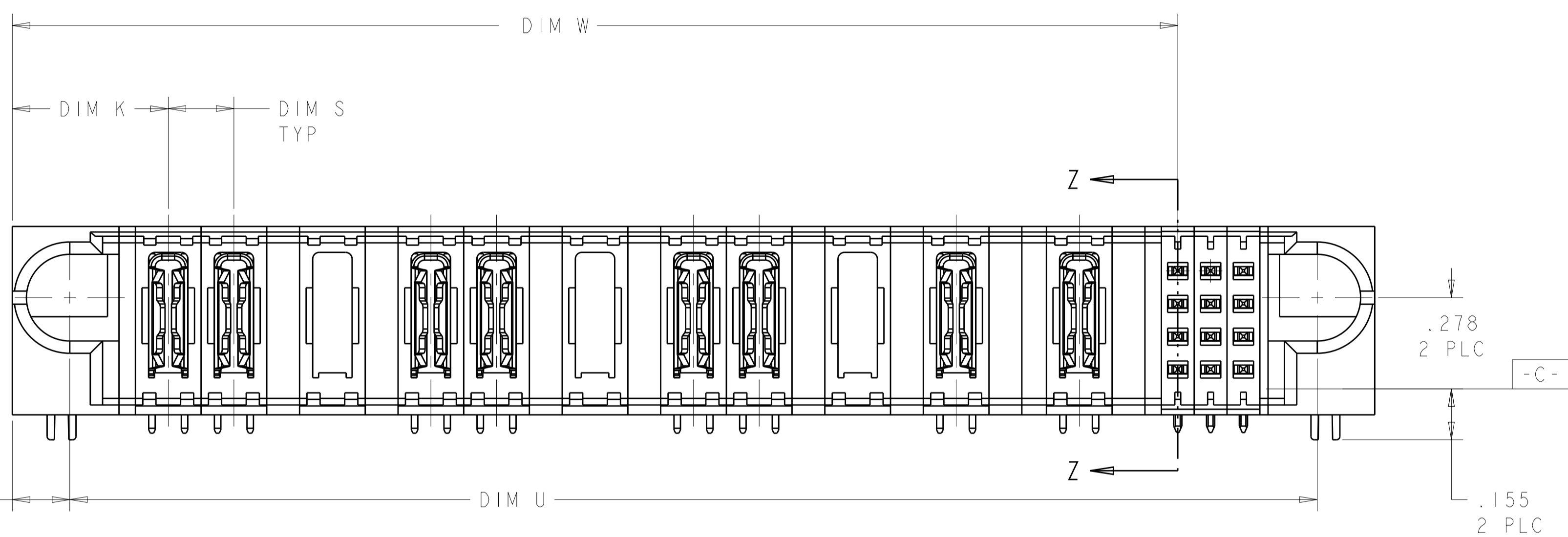

-	3.850	3.800	3.550	-	4.150	IIP + 12S	1892302-2
8	3.850	3.800	3.550	.475	4.150	IIP + 12S	1892302-1
DIM S	DIM D	DIM U	DIM W	DIM K	DIM L	DESCRIPTION	PART NUMBER

THIS DRAWING IS A CONTROLLED DOCUMENT.

DIMENSIONS: INCHES

TOLERANCES UNLESS OTHERWISE SPECIFIED:

0 PLC	±	
1 PLC	±0.1	
2 PLC	±0.02	
3 PLC	±linear.tol.	
4 PLC	±linear.tol.	
ANGLES	±	

MATERIAL: - FINISH: -

Customer Drawing

DWN: C. ZHOU 08MAY2007  
CHK: S. ZHAO 08MAY2007  
APVD: S. YAO

NAME: -  
PRODUCT SPEC: 108-1973  
APPLICATION SPEC: 114-13038

WEIGHT: -

SCALE: 4:1 SHEET 1 OF 3 REV: B1

RESTRICTED TO: -

SIZE: A1 CAGE CODE: 1892302

TE Connectivity

RIGHT ANGLE HEADER ASSEMBLY  
DUAL BEAM POWER CONTACT  
MULTI-BEAM XL

LOC	DIST	REVISIONS			
P	LTN	DESCRIPTION	DATE	DMN	APVD
-	-	SEE SHEET 1	-	-	-

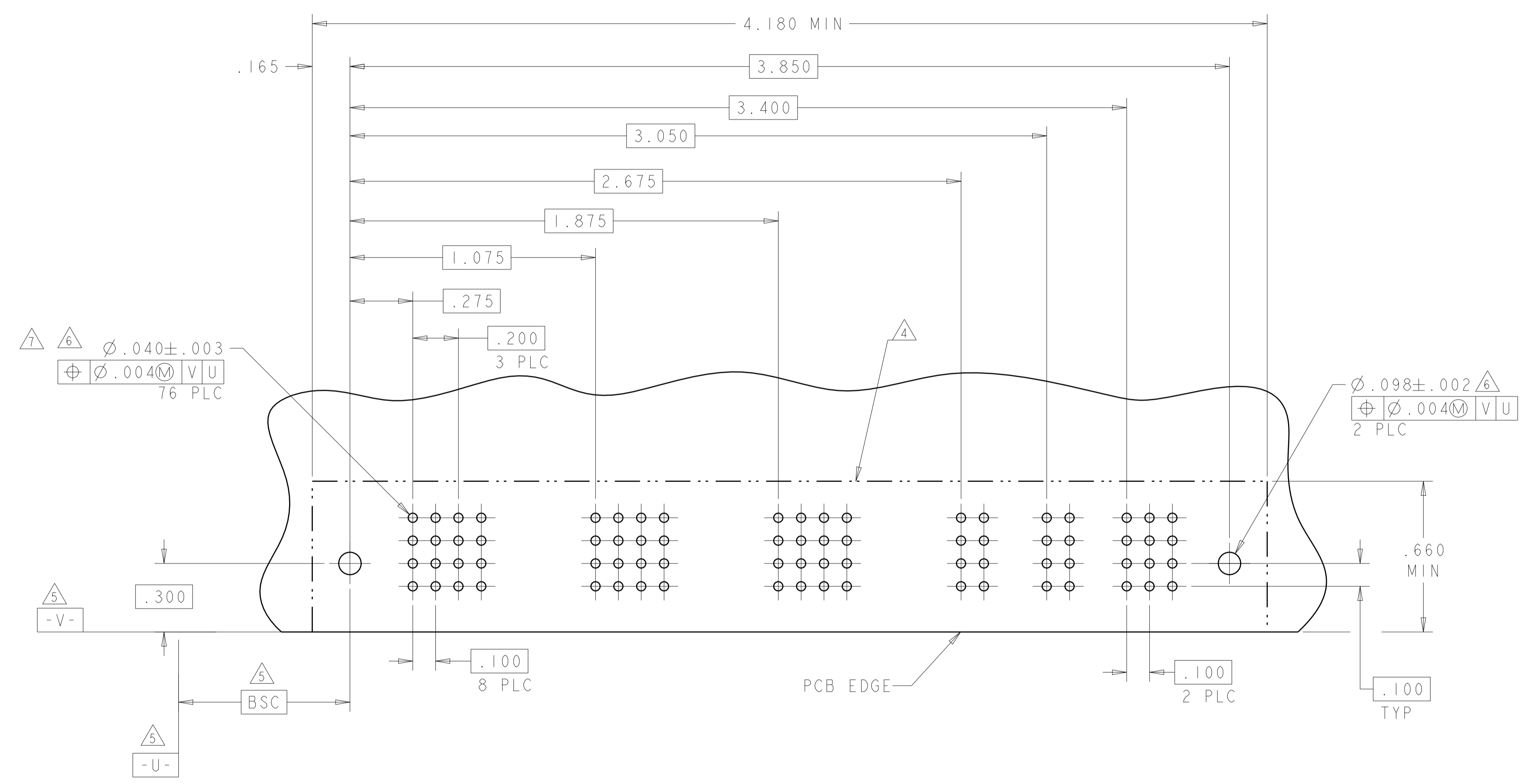
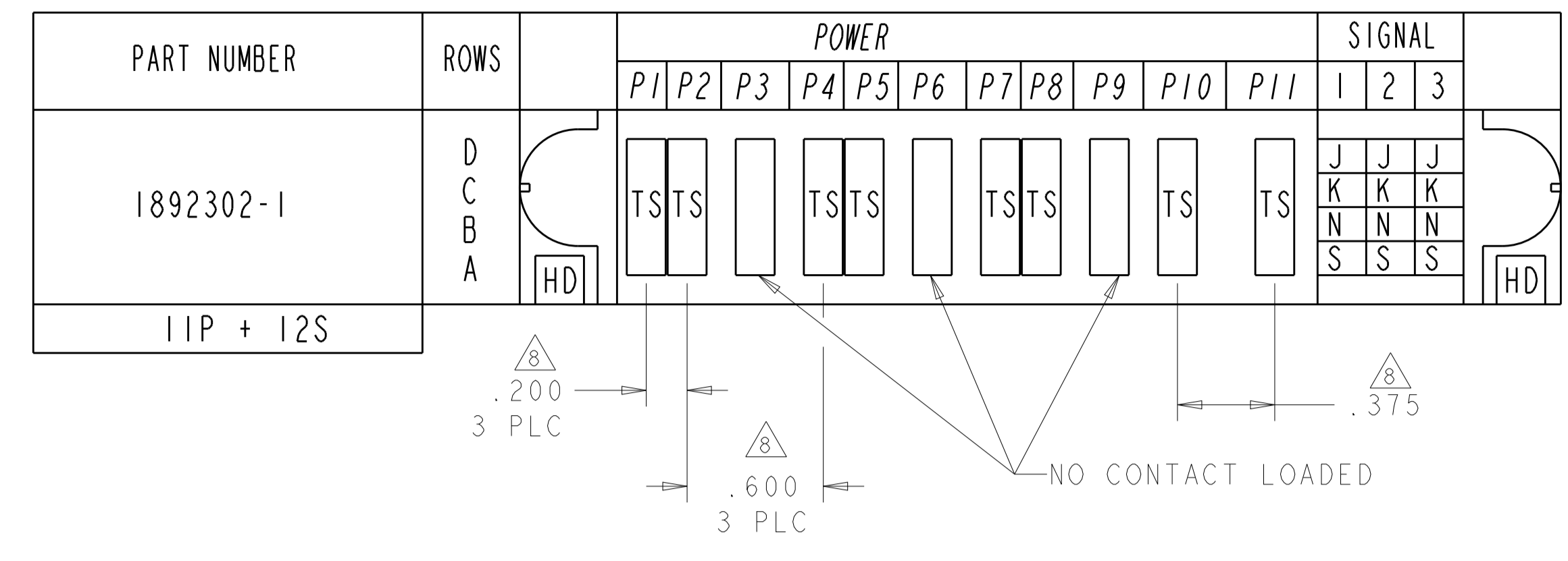

CODE	DESCRIPTION	ROW
S	STD SIGNAL CONTACT	A
N	STD SIGNAL CONTACT	B
K	STD SIGNAL CONTACT	C
J	STD SIGNAL CONTACT	D
TS	STD POWER CONTACT (DUAL BEAM)	-

CONTACTS

THIS DRAWING IS A CONTROLLED DOCUMENT.

DIMENSIONS: INCHES	TOLERANCES UNLESS OTHERWISE SPECIFIED: 0 PLC ± 1 PLC ±0.1 2 PLC ±0.02 3 PLC ±linear tol. 4 PLC ±linear tol. ANGLES ±	OWN: C. ZHOU 08MAY2007 CHK: S. ZHAO 08MAY2007 APVD: S. YAO	NAME: RIGHT ANGLE HEADER ASSEMBLY DUAL BEAM POWER CONTACT MULTI-BEAM XL
MATERIAL	FINISH	PRODUCT SPEC: 108-1973 APPLICATION SPEC: 114-13038 WEIGHT	SIZE: A100779 CAGE CODE: 1892302

Customer Drawing SCALE 4:1 SHEET 2 OF 3 REV B1

LOC	DIST	REVISIONS			
P	LTN	DESCRIPTION	DATE	DMN	APVD
-	-	SEE SHEET 1	-	-	-

PART NUMBER	ROWS	POWER										SIGNAL				
		P1	P2	P3	P4	P5	P6	P7	P8	P9	P10	P11	1	2	3	
1892302-2	D												J	J	J	
	C												K	K	K	
	B													N	N	N
	A		HD											S	S	S
12S																

NO CONTACTS LOADED

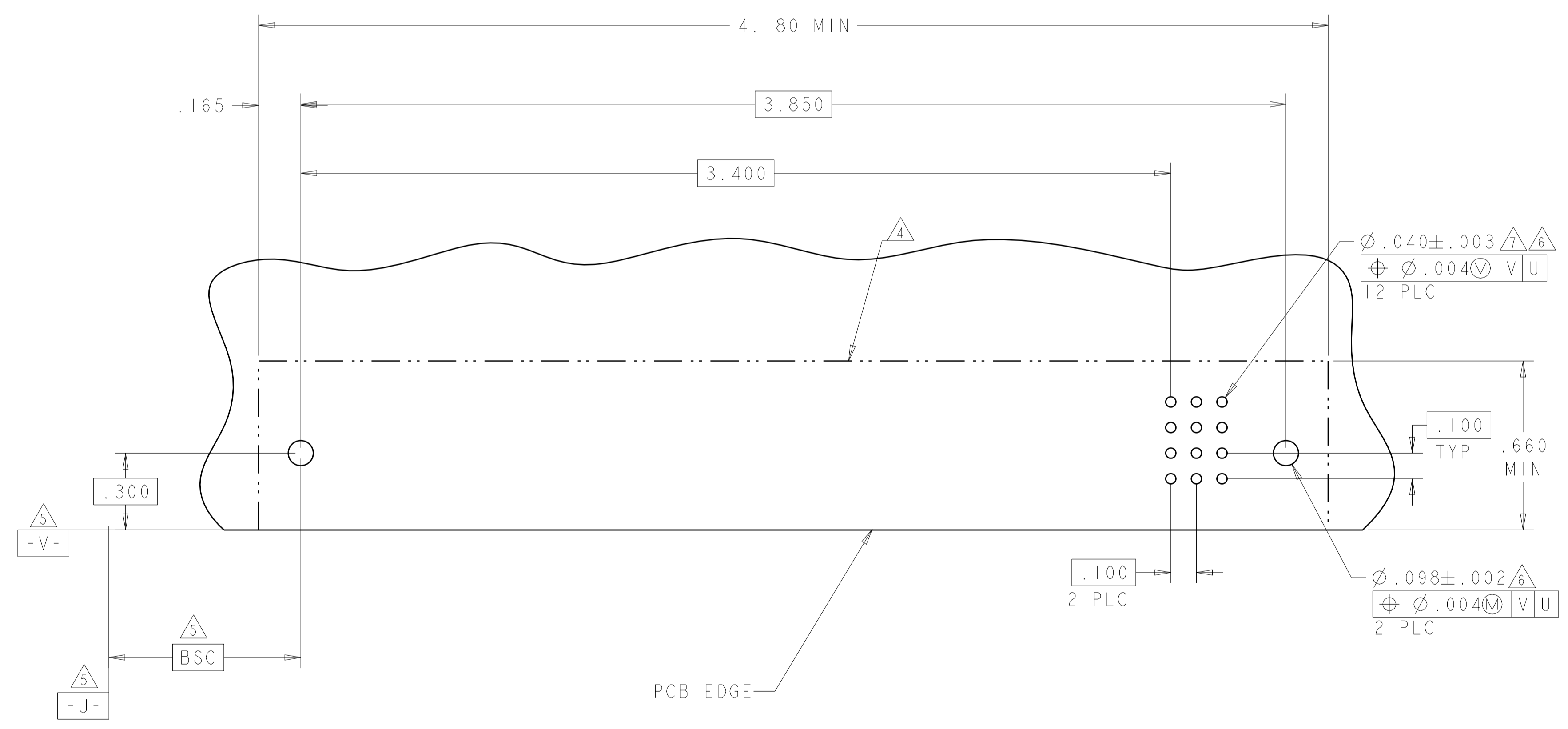

THIS DRAWING IS A CONTROLLED DOCUMENT.		DMN C. ZHOU CHK S. ZHAO	08MAY2007 08MAY2007	TE Connectivity
DIMENSIONS: INCHES	TOLERANCES UNLESS OTHERWISE SPECIFIED:	APVD S. YAO	NAME -	
	0 PLC ± 1 PLC ±0.1 2 PLC ±0.02 3 PLC ±linear tol. 4 PLC ±linear tol. ANGLES ±	PRODUCT SPEC 108-1973	ADDITIONAL SPEC 114-13038	<b>RIGHT ANGLE HEADER ASSEMBLY DUAL BEAM POWER CONTACT MULTI-BEAM XL</b>
MATERIAL	FINISH	WEIGHT	SIZE A100779	CAGE CODE C=1892302
Customer Drawing		SCALE 4:1	SHEET 3	OF 3
			REV B1	

## X-ON Electronics

Largest Supplier of Electrical and Electronic Components

*Click to view similar products for [Power to the Board](#) category:*

*Click to view products by [TE Connectivity](#) manufacturer:*

Other Similar products are found below :

[10131318-08512GRLF](#) [6450171-4](#) [6450552-7](#) [6600323-8](#) [6643429-1](#) [6646040-2](#) [6651939-1](#) [6766604-1](#) [120959-1](#) [1393557-2](#) [1393532-2](#)  
[1393532-3](#) [1393532-4](#) [1393557-1](#) [1600812-5](#) [1-6450861-2](#) [1645595-1](#) [1743490-1](#) [1744132-7](#) [1761122-1](#) [1766169-1](#) [1766250-1](#) [18362](#)  
[1892109-1](#) [1-967627-6](#) [2226808-1](#) [2-6450860-5](#) [2-6450860-6](#) [2-6450870-0](#) [93003-0502](#) [953552-1](#) [1-6450161-4](#) [1-6450850-6](#) [1645526-2](#) [1-](#)  
[6600130-0](#) [1743419-1](#) [1766150-1](#) [2005243-2](#) [211110-1](#) [2-6600130-2](#) [TE34-12-16P-F0](#) [51700-10201602AALF](#) [5-6450830-6](#) [5646956-4](#)  
[36662-0005](#) [40585-3000](#) [4-6450830-9](#) [4-6600333-3](#) [51142-0214](#) [10125416-4050LF](#)