

THIS DRAWING IS UNPUBLISHED. RELEASED FOR PUBLICATION  
 © COPYRIGHT copyright.d8te- ALL RIGHTS RESERVED.

REVISIONS				
P	LTR	DESCRIPTION	DATE	APVD
C1		REVISED PER ECR-21-100237	22JAN2021	SK DZ

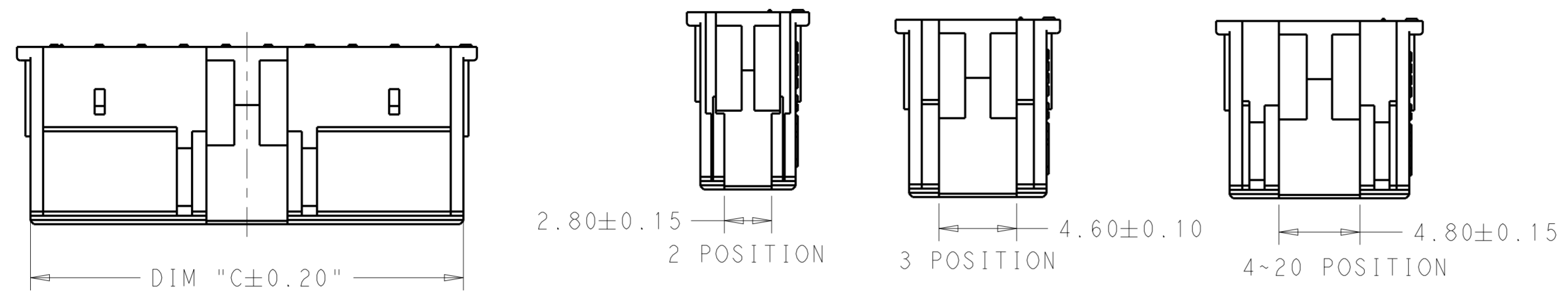

- 1 MATERIAL: NYLON UL94V-0
- 2 ACCEPTS TE RECEPTACLE P/N'S 2110989-( )
- 3 THESE HOUSINGS CAN ACCEPT OPTIONAL TPA ( RETAINER ) P/N 1969443-( ).
- 4 MATES WITH TE HEADER ASSEMBLIES 2132230-( ) & 2132415-( ).

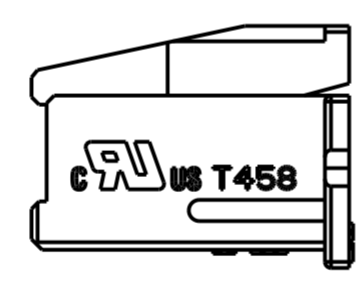
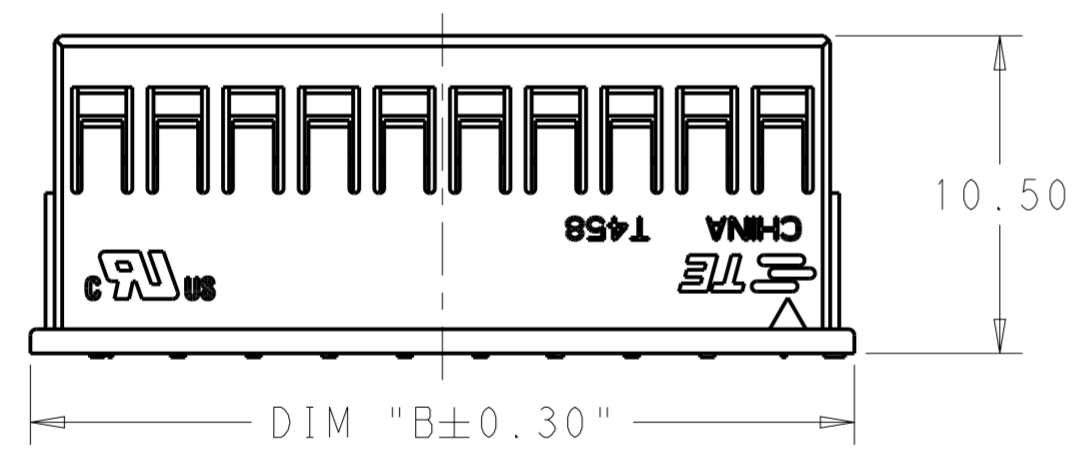
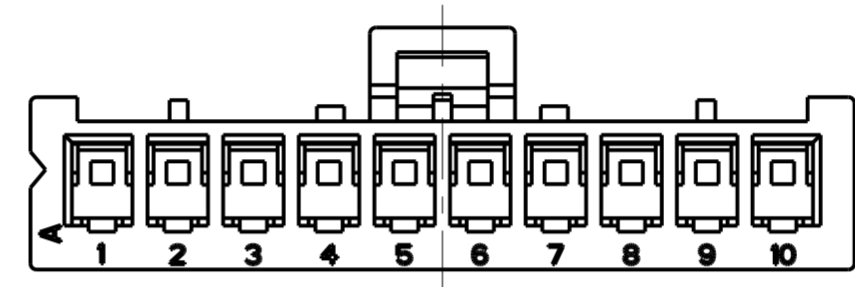
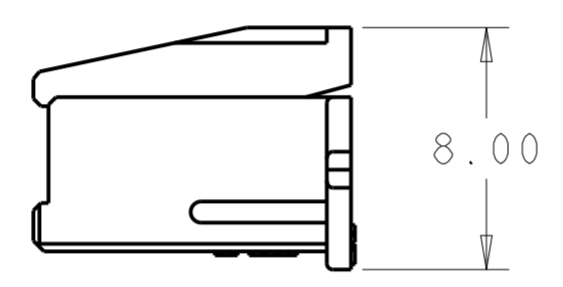
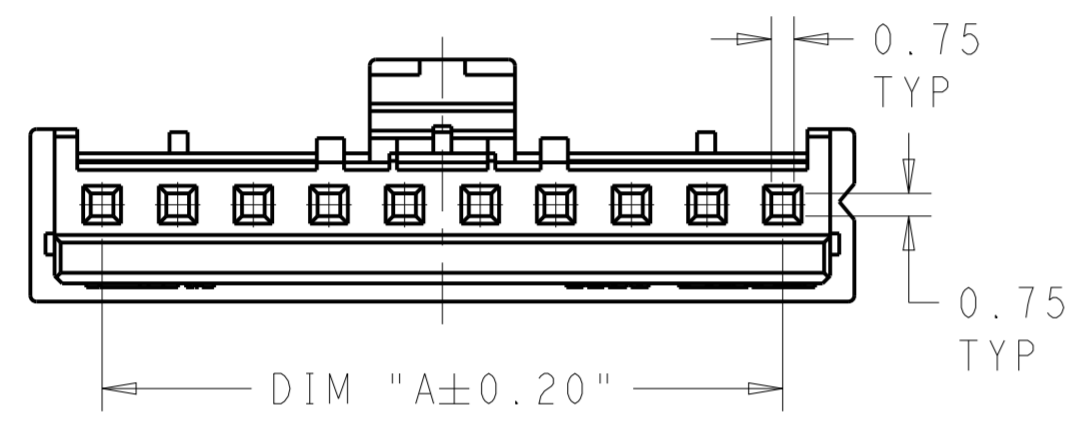

ALTERNATE LOCATION FOR 2 AND 3 POSITION PARTS

LOCATION FOR 4~20 POSITION PARTS

COLOR	DIM C	DIM B	DIM A	NO. OF POSITIONS	PART NUMBER
NATURAL	50.64	52.3	47.5	20	2-1969442-0
NATURAL	48.14	49.8	45.0	19	1-1969442-9
NATURAL	45.64	47.3	42.5	18	1-1969442-8
NATURAL	43.14	44.8	40.0	17	1-1969442-7
NATURAL	40.64	42.3	37.5	16	1-1969442-6
NATURAL	38.14	39.8	35.0	15	1-1969442-5
NATURAL	35.64	37.3	32.5	14	1-1969442-4
NATURAL	33.14	34.8	30.0	13	1-1969442-3
NATURAL	30.64	32.3	27.5	12	1-1969442-2
NATURAL	28.14	29.8	25.0	11	1-1969442-1
NATURAL	25.64	27.3	22.5	10	1-1969442-0
NATURAL	23.14	24.8	20.0	9	1969442-9
NATURAL	20.64	22.3	17.5	8	1969442-8
NATURAL	18.14	19.8	15.0	7	1969442-7
NATURAL	15.64	17.3	12.5	6	1969442-6
NATURAL	13.14	14.8	10.0	5	1969442-5
NATURAL	10.64	12.3	7.5	4	1969442-4
NATURAL	8.14	9.8	5.0	3	1969442-3
NATURAL	5.64	7.3	2.5	2	1969442-2

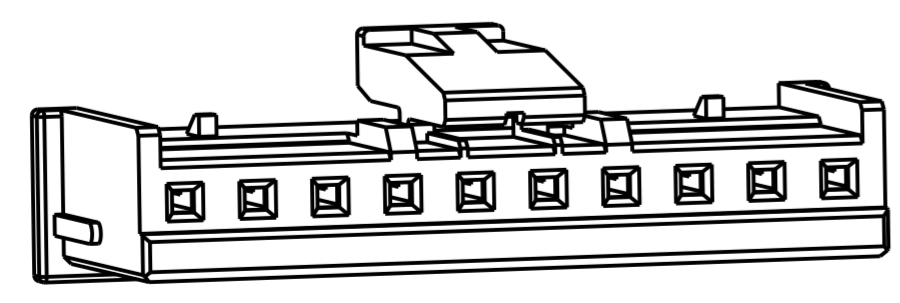

THIS DRAWING IS A CONTROLLED DOCUMENT.

DWN: JR RUTH 09SEP2016  
 CHK: TOM MICHIELUTTI 27FEB14  
 APVD: TOM MICHIELUTTI 27FEB14

TE Connectivity  
**STE**

ECONOMY POWER 2.5 TPA HOUSING

108-2418  
 114-13315

SIZE: A2  
 SCALE: N/A  
 SHEET: 1 OF 1  
 REV: C1

Customer Drawing

## X-ON Electronics

Largest Supplier of Electrical and Electronic Components

*Click to view similar products for [Headers & Wire Housings](#) category:*

*Click to view products by [TE Connectivity](#) manufacturer:*

Other Similar products are found below :

[892-18-020-10-001101](#) [58102-G61-06LF](#) [582553-1](#) [0009485154](#) [009176003701906](#) [0050291907](#) [LY20-4P-DT1-P1E-BR](#) [02.125.8002.8](#)  
[609-3404](#) [61062-3](#) [61082-181009](#) [622-3653LF](#) [63453-116](#) [636-1030](#) [636-1427](#) [636-3427](#) [636-4007](#) [641938-9](#) [641991-4](#) [644827-2](#) [65817-](#)  
[010LF](#) [65817-015LF](#) [65863-015LF](#) [66207-023LF](#) [67095-007LF](#) [67601157](#) [68645-018](#) [68648-049](#) [70.362.1628.0](#) [70-4210](#) [70-4226B](#) [70-](#)  
[4853B](#) [707-5020](#) [707-5028](#) [71.350.2428.0](#) [71918-208LF](#) [71961-016LF](#) [733-134](#) [733-162](#) [754199-000](#) [760-3052](#) [787-8014-00](#) [79531-3000](#)  
[FCN-360C032-B](#) [FCN-367T-T012/H](#) [FCN-723D010/2](#) [80.063.4001.1](#) [800-90-001-10-001000](#) [800-90-010-10-002000](#) [801-43-002-10-013000](#)