

THIS DRAWING IS UNPUBLISHED. RELEASED FOR PUBLICATION  
 © COPYRIGHT copyright.d8Te- ALL RIGHTS RESERVED.

REVISIONS				
P	LTR	DESCRIPTION	DATE	APVD
B		RELEASED PER ECR-21-100757	04MAR2021	SK DZ
B2		RELEASED PER ECR-21-121051	23NOV2021	SK DZ

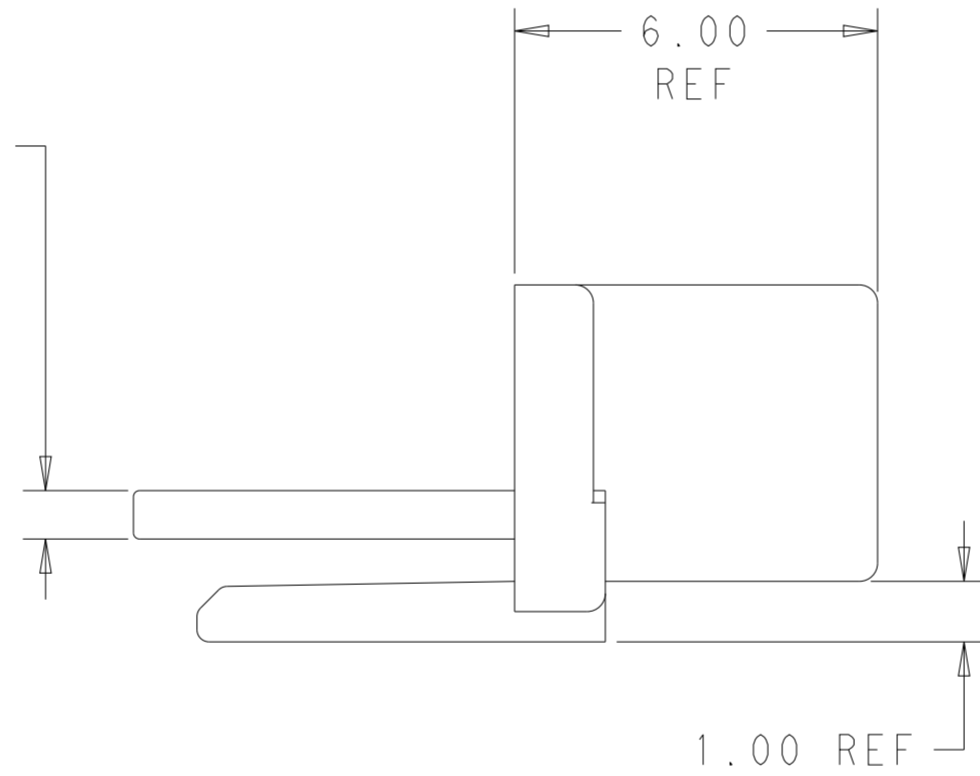
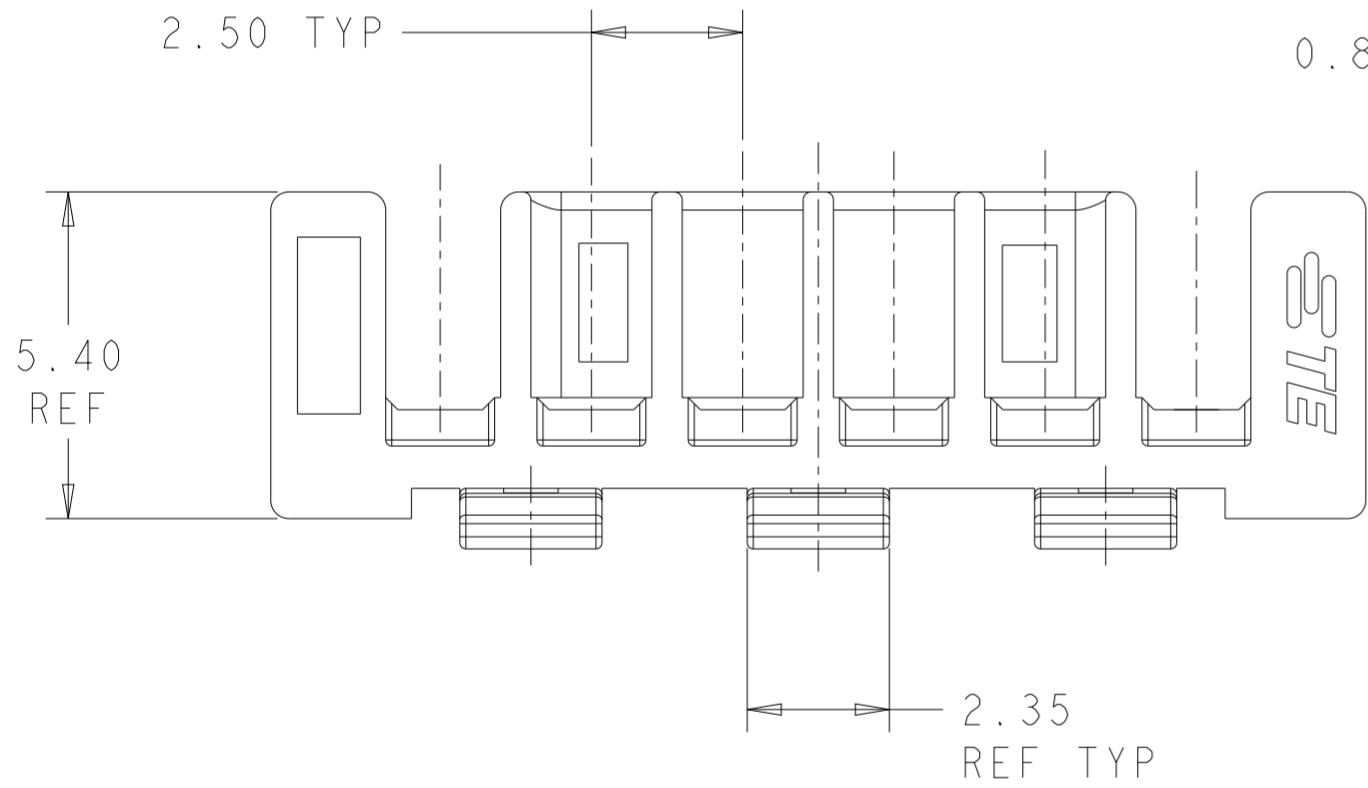
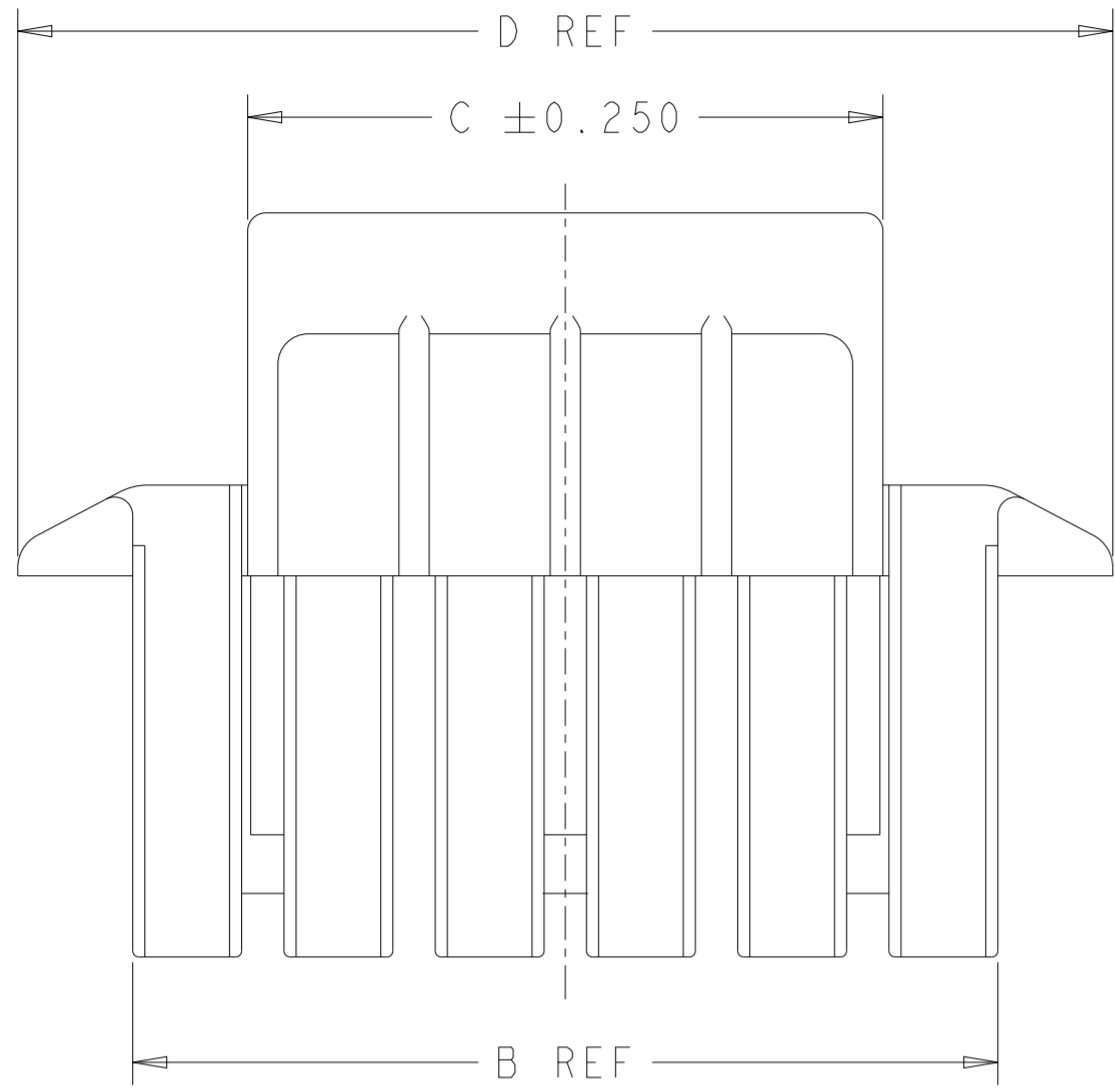

- 1 MATERIAL; HIGH PERFORMANCE RISIN, UL94-V0, GLASS FILLED, COLOR - BLACK
- 2 MATES WITH HOUSING 1969442-(X)

53.1	10.5	49.3	20	2-1969825-0
50.6	13	46.8	19	1-1969825-9
48.1	10.5	44.3	18	1-1969825-8
45.6	13	41.8	17	1-1969825-7
43.1	10.5	39.3	16	1-1969825-6
40.6	13	36.8	15	1-1969825-5
38.1	10.5	34.3	14	1-1969825-4
35.6	13	31.8	13	1-1969825-3
33.1	10.5	29.3	12	1-1969825-2
30.6	13	26.8	11	1-1969825-1
28.1	10.5	24.3	10	1-1969825-0
25.6	13	21.8	9	1969825-9
23.1	10.5	19.3	8	1969825-8
20.6	13	16.8	7	1969825-7
18.1	10.5	14.3	6	1969825-6
16.7	13	11.8	5	1969825-5
14.2	10.5	9.3	4	1969825-4
11.7	8	6.8	3	1969825-3
8.1	5.5	4.3	2	1969825-2
DIM D	DIM C	DIM B	POSITIONS	PART NO.

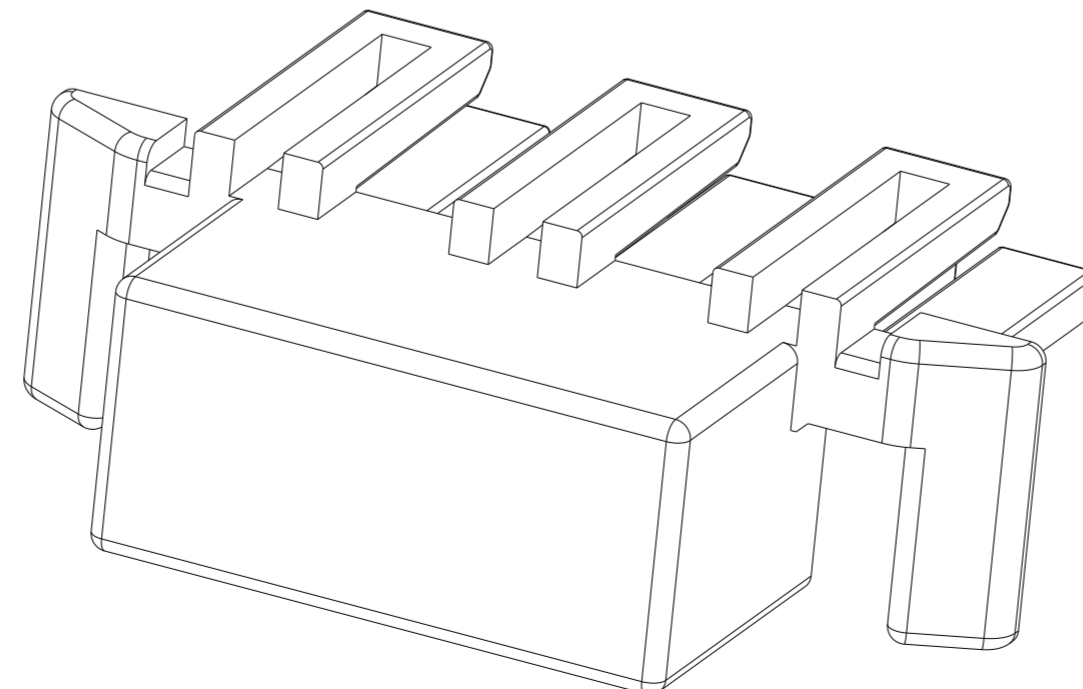
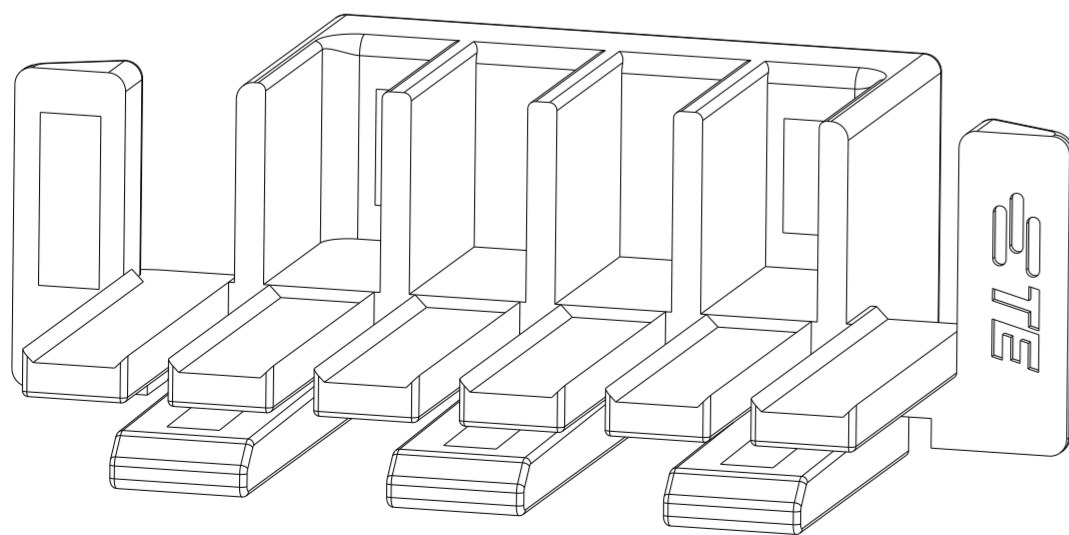

THIS DRAWING IS A CONTROLLED DOCUMENT.

DWN	JR RUTH	20-Jan-16
CHK	D. FAROLE	20JAN16
APVD	D. FAROLE	20JAN16
PRODUCT SPEC		
APPLICATION SPEC		
WEIGHT		
CUSTOMER DRAWING	SCALE	N/A

TE Connectivity

ECONOMY POWER 2.5 TPA RETAINER

SIZE: A2 CAGE CODE: - DRAWING NO: C-1969825 RESTRICTED TO: -

SHEET 1 OF 2 REV B2

THIS DRAWING IS UNPUBLISHED. RELEASED FOR PUBLICATION  
 © COPYRIGHT copyright.d8Te- ALL RIGHTS RESERVED.

REVISIONS					
P	LTR	DESCRIPTION	DATE	DWN	APVD
-	-	SEE SHEET 1	-	-	-

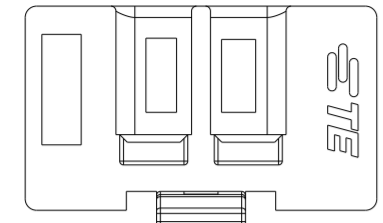

1969825-2

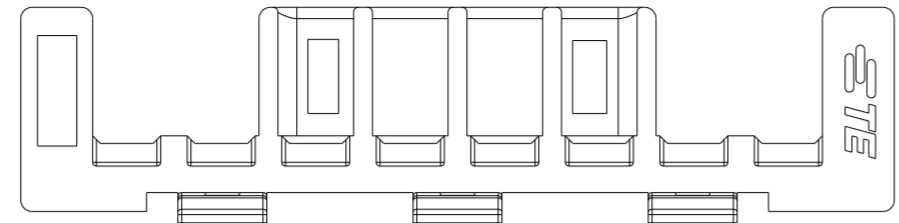

1969825-8

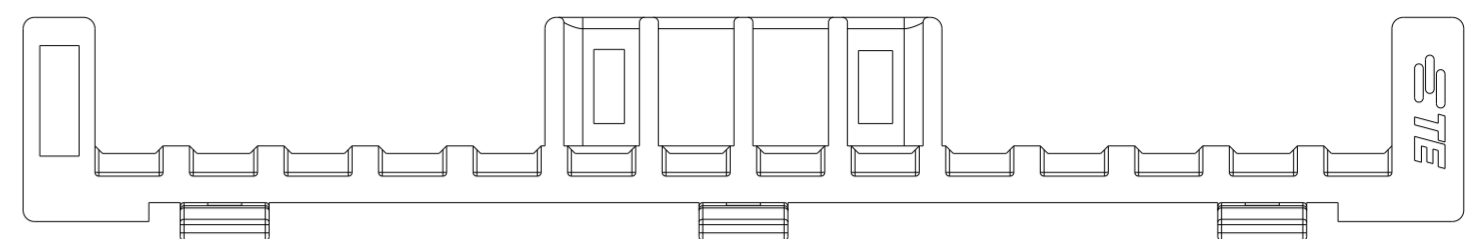

1-1969825-4

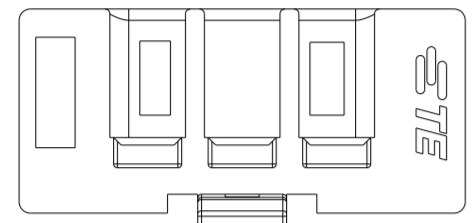

1969825-3

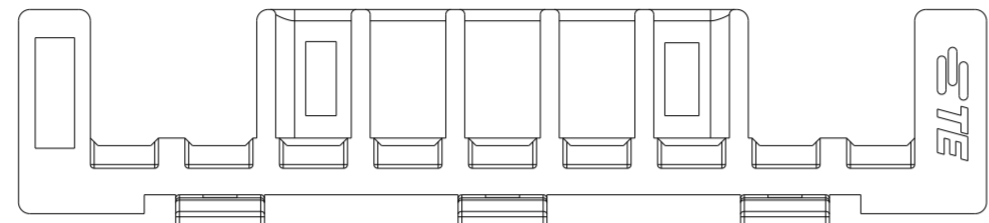

1969825-9

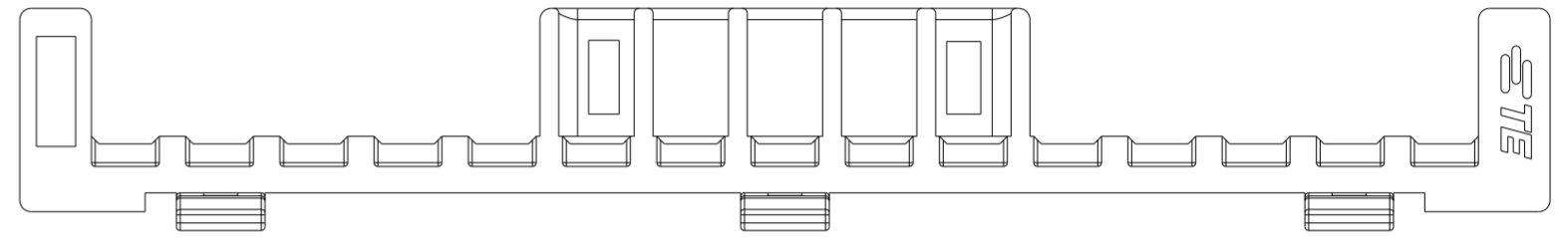

1-1969825-5

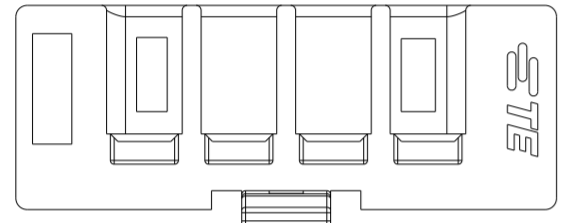

1969825-4

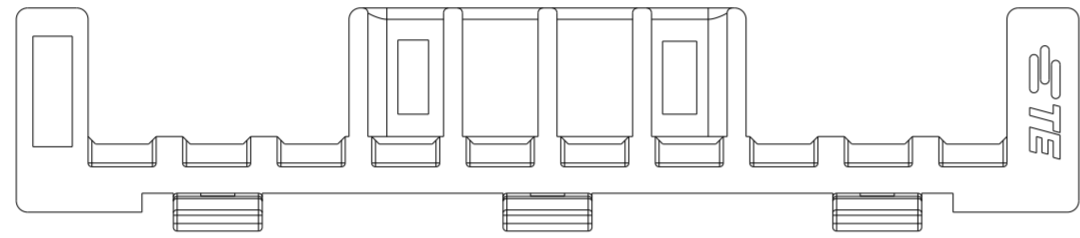

1-1969825-0

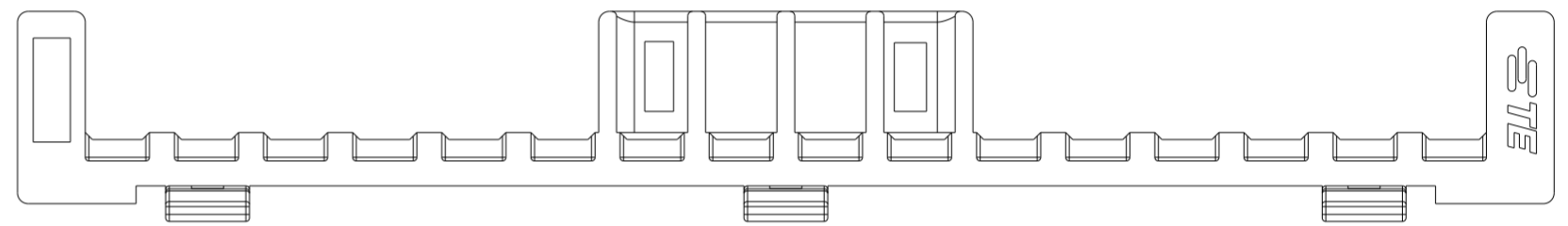

1-1969825-6

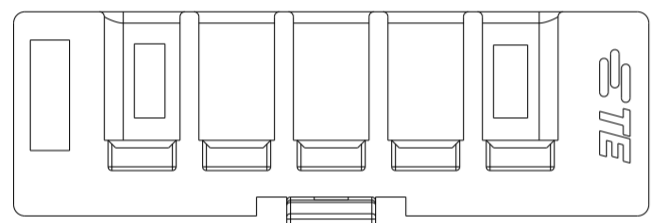

1969825-5

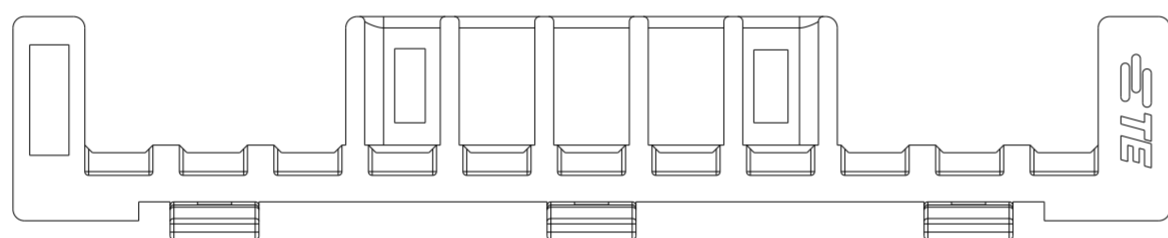

1-1969825-1

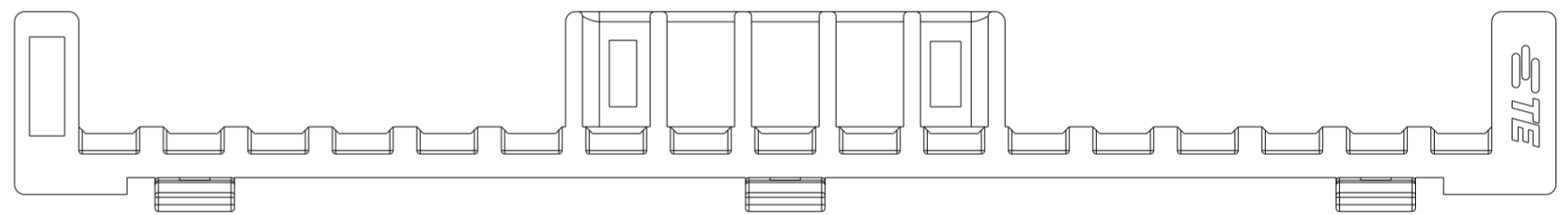

1-1969825-7

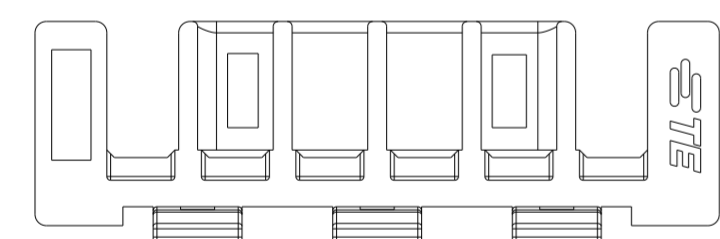

1969825-6

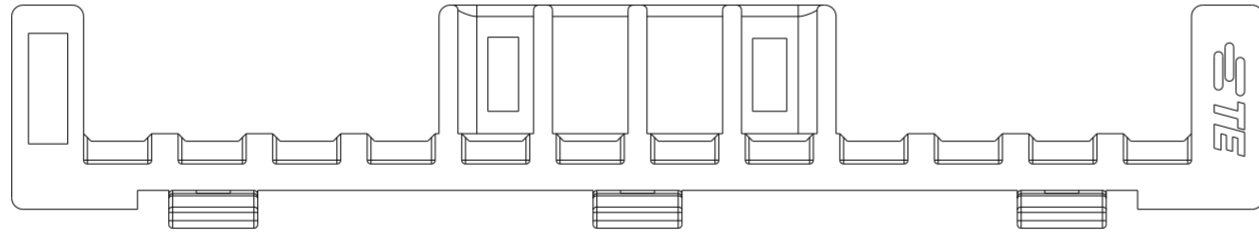

1-1969825-2

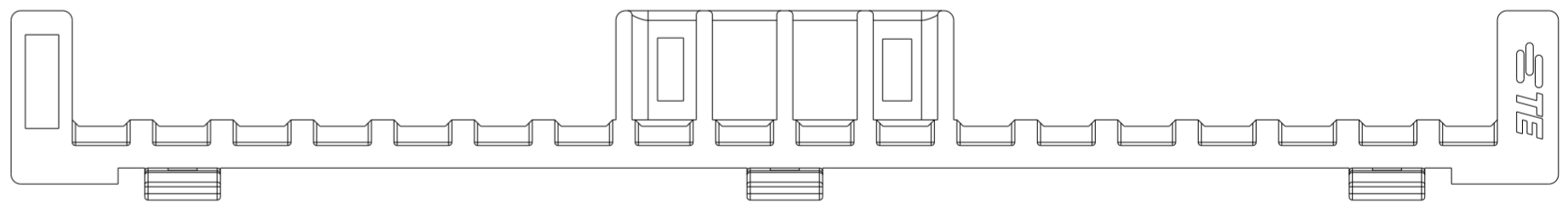

1-1969825-8

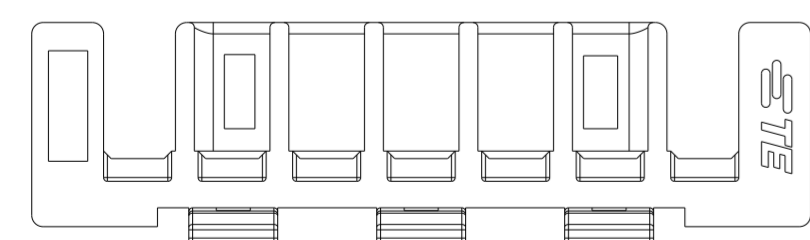

1969825-7

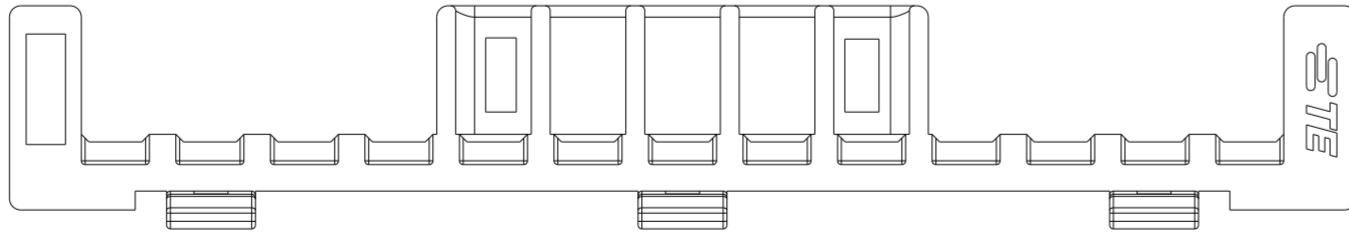

1-1969825-3

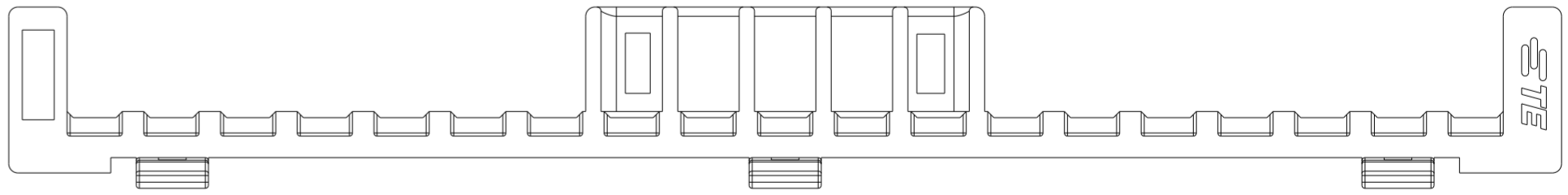

1-1969825-9

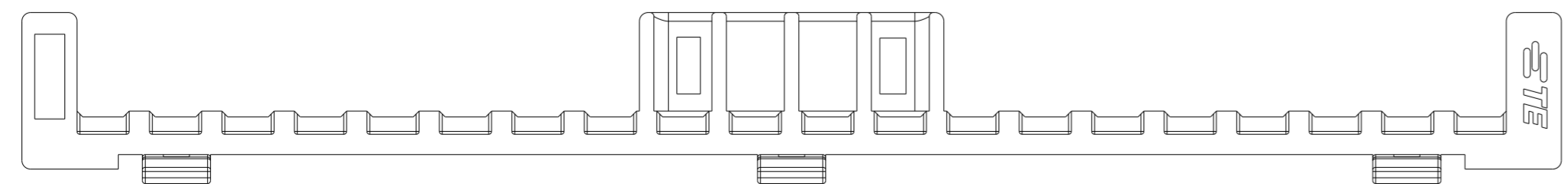

2-1969825-0

THIS DRAWING IS A CONTROLLED DOCUMENT.		DWN	JR RUTH	20-Jan-16	 TE Connectivity	NAME		ECONOMY POWER 2.5 TPA RETAINER			
DIMENSIONS:		CHK	D. FAROLE	20JAN16		SIZE		A2	CAGE CODE	-	RESTRICTED TO
mm	TOLERANCES UNLESS OTHERWISE SPECIFIED:	APVD	D. FAROLE	20JAN16		DRAWING NO		C-1969825		-	
0 PLC	±	PRODUCT SPEC	APPLICATION SPEC			SCALE		N/A	SHEET	2 OF 2	REV
1 PLC	±	WEIGHT	CUSTOMER DRAWING		SCALE		N/A	SHEET	2 OF 2	REV	B2
2 PLC	±0.13	MATERIAL		SCALE		N/A	SHEET	2 OF 2	REV	B2	
3 PLC	±	FINISH		SCALE		N/A	SHEET	2 OF 2	REV	B2	
4 PLC	±	FINISH		SCALE		N/A	SHEET	2 OF 2	REV	B2	
ANGLES	±	FINISH		SCALE		N/A	SHEET	2 OF 2	REV	B2	
FINISH	±	FINISH		SCALE		N/A	SHEET	2 OF 2	REV	B2	

## X-ON Electronics

Largest Supplier of Electrical and Electronic Components

*Click to view similar products for [Headers & Wire Housings](#) category:*

*Click to view products by [TE Connectivity](#) manufacturer:*

Other Similar products are found below :

[892-18-020-10-001101](#) [58102-G61-06LF](#) [582553-1](#) [0009485154](#) [009176003701906](#) [0050291907](#) [LY20-4P-DT1-P1E-BR](#) [02.125.8002.8](#)  
[609-3404](#) [61062-3](#) [61082-181009](#) [622-3653LF](#) [63453-116](#) [636-1030](#) [636-1427](#) [636-3427](#) [636-4007](#) [641938-9](#) [641991-4](#) [644827-2](#) [65817-](#)  
[010LF](#) [65817-015LF](#) [65863-015LF](#) [66207-023LF](#) [67095-007LF](#) [67601157](#) [68645-018](#) [68648-049](#) [70.362.1628.0](#) [70-4210](#) [70-4226B](#) [70-](#)  
[4853B](#) [707-5020](#) [707-5028](#) [71.350.2428.0](#) [71918-208LF](#) [71961-016LF](#) [733-134](#) [733-162](#) [754199-000](#) [760-3052](#) [787-8014-00](#) [79531-3000](#)  
[FCN-360C032-B](#) [FCN-367T-T012/H](#) [FCN-723D010/2](#) [80.063.4001.1](#) [800-90-001-10-001000](#) [800-90-010-10-002000](#) [801-43-002-10-013000](#)