

THIS DRAWING IS UNPUBLISHED. RELEASED FOR PUBLICATION 20  
 © COPYRIGHT 20 BY - ALL RIGHTS RESERVED.

LOC		DIST		REVISIONS			
P	LTR	DESCRIPTION		DATE	DWN	APVD	
A6		ECR-15-016520		25NOV2015	SL	RR	
A7		ECR-17-001536		03FEB2017	IZ	RR	
A8		ECR-18-008584		05JUN2018	BW	LZ	
A9		ECR-18-009485		19MAY2019	BW	WW	

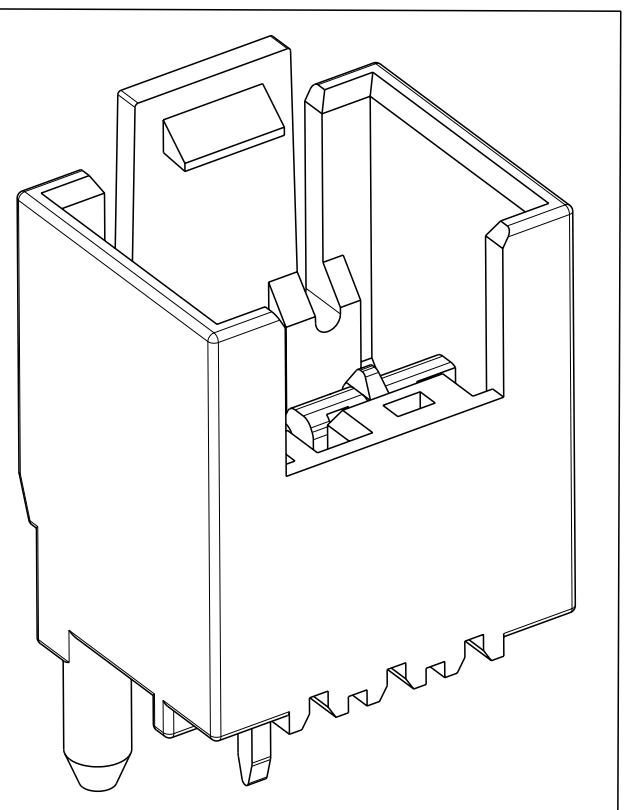
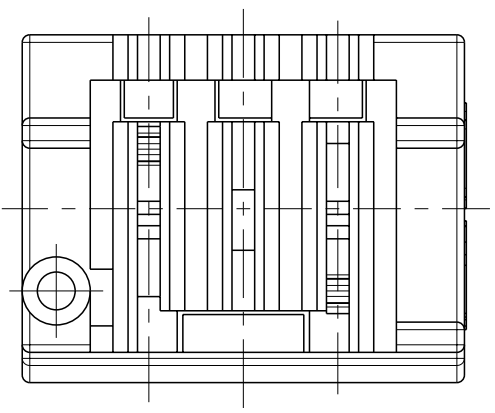
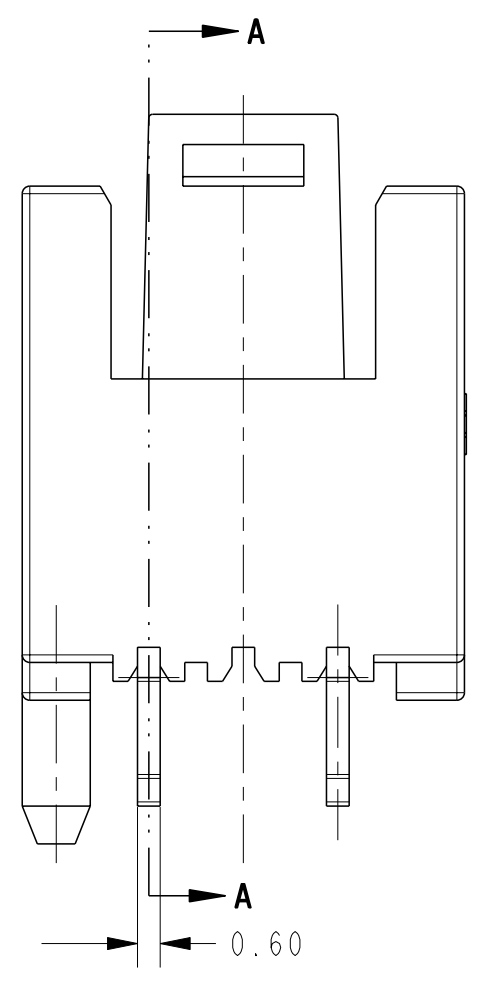
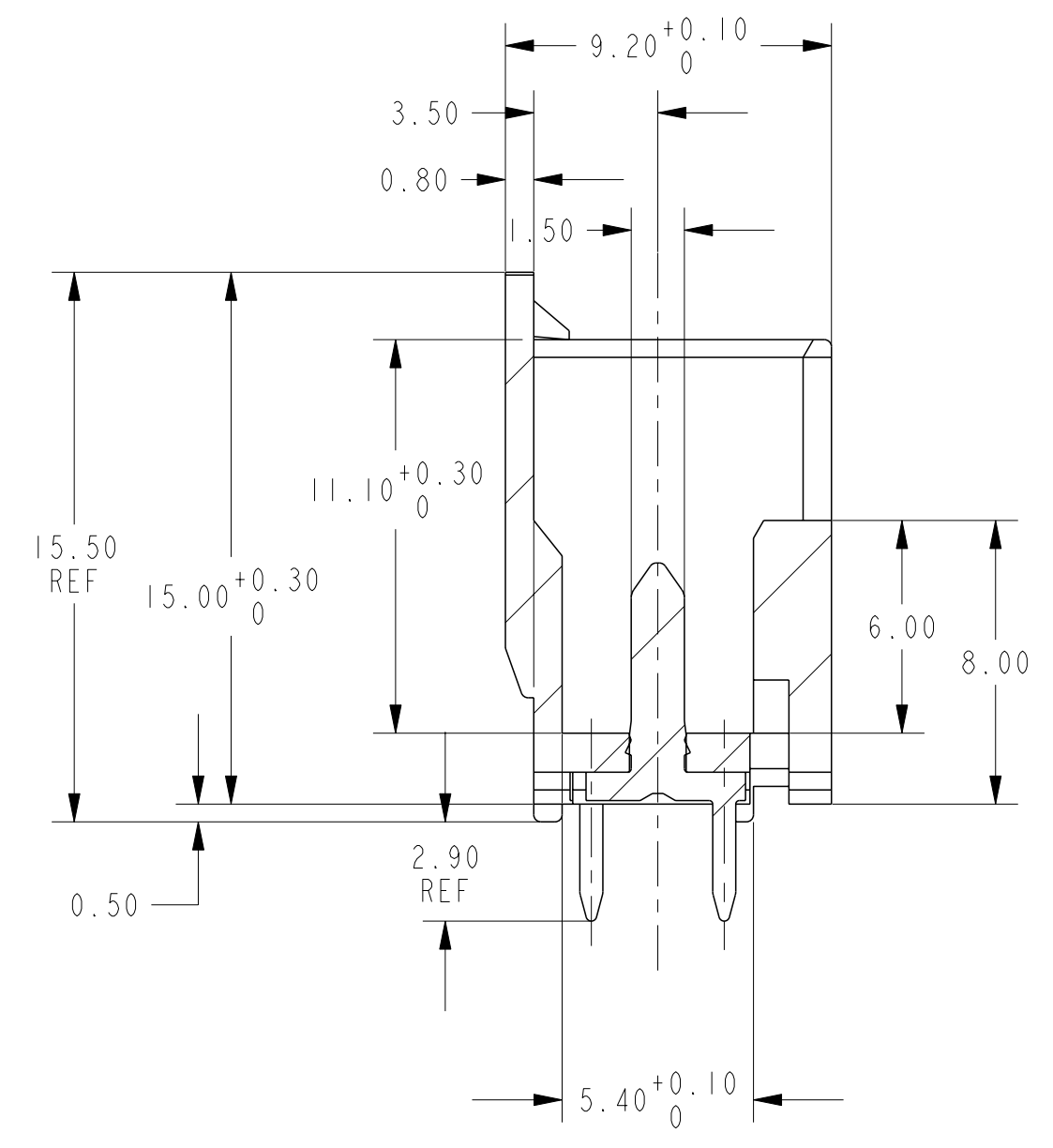
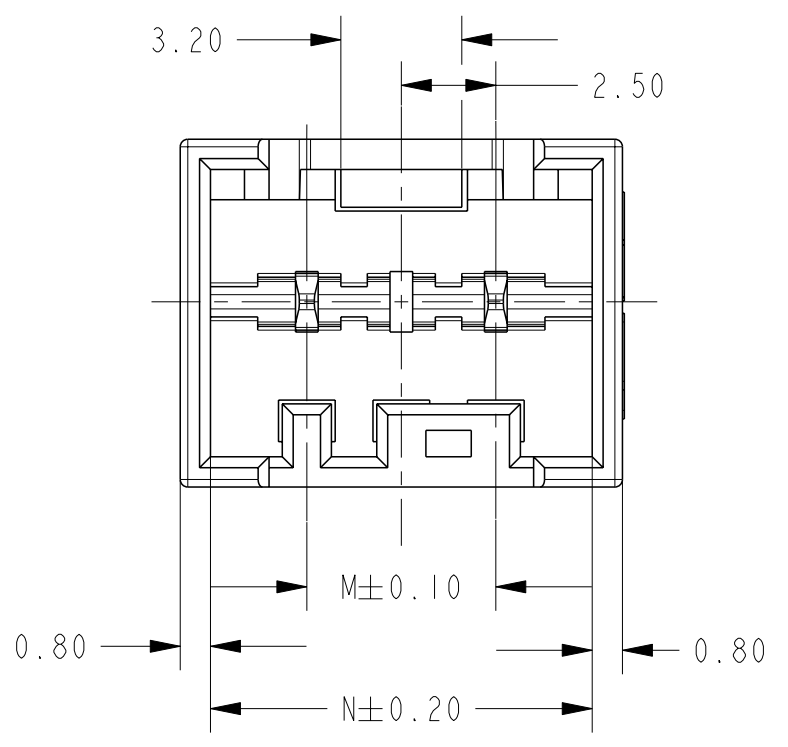

**NOTE**

- SEE SHEET 2 FOR AVAILABLE CONFIGURATIONS
- MATERIAL: HOUSING, NYLON, UL94 V0, 750°C GWT NO FLAME  
EIGHT COLORS AVAILABLE, INCLUDING: NATURAL, RED, BLUE, YELLOW, BLACK, GREY, GREEN, PURPLE  
WHITE VERSION IS PRELIMINARY  
  
CONTACT, COPPER ALLOY, 0.60MM THICK
- FINISH: OPTION 1: TIN PLATING OVER NICKEL UNDERPLATING  
OPTION 2: AG PLATING OVER NICKEL UNDERPLATING
- PCB LAYOUT AS SHOWN
- △ THE PART NUMBERS SHOWING IN SHEET 2 & 3 ARE FOR NATURAL COLOR. THE PART NUMBER FOR OTHER COLOR ARE BASED ON THE NATURAL ONE: FOR THE SAME CONFIGURATION, THE PREFIX AND POSTFIX OF THE P/N ARE THE SAME, ONLY THE BASE NUMBER IS DIFFERENT ACCORDING TO DIFFERENT COLOR, DETAIL PLEASE SEE SHEET 4
- PACKAGING: LOOSE PIECE OR TUBE. THE PART NUMBERS IN THIS DRAWING ARE WITH LOOSE PIECE PACKAGING. PLEASE CONTACT TE SALES REPRESENTATIVES FOR TUBE PACKAGING REQUIREMENT.
- △ PRELIMINARY PART NOT RELEASED FOR PRODUCTION

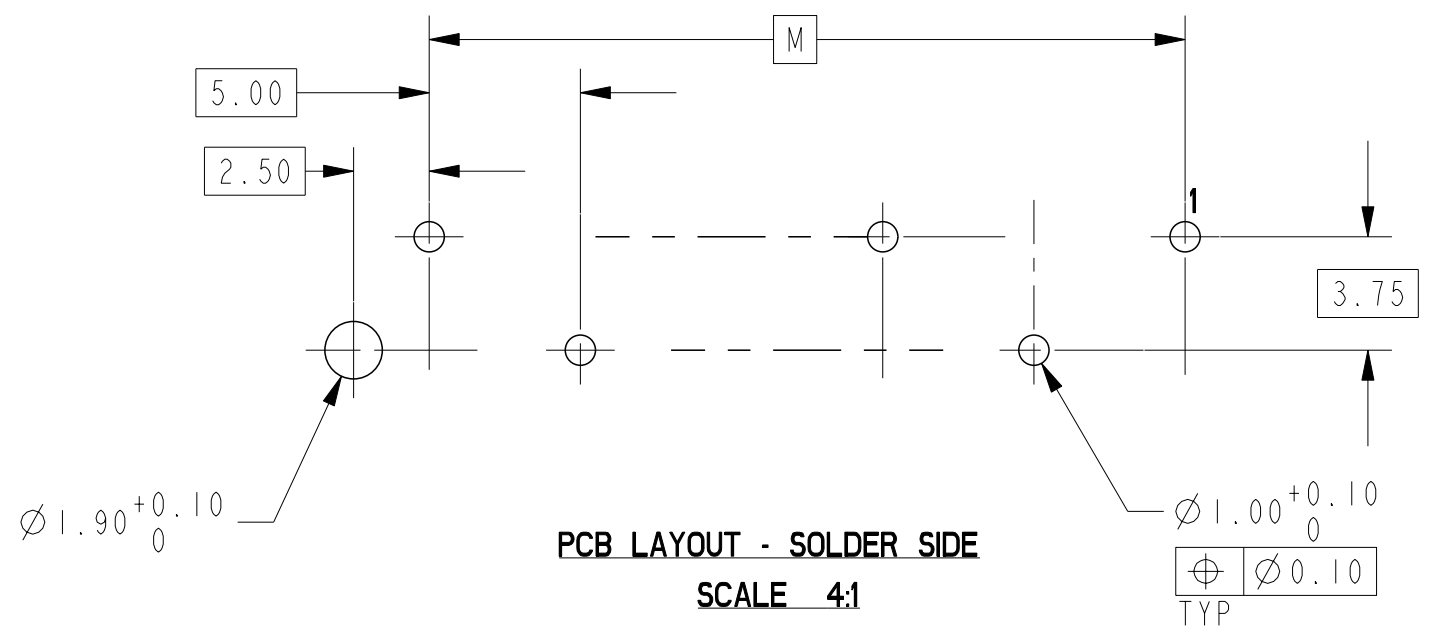

N	M	NO. OF POS.
40.10	35.00	8 LOAD, 15 POS.
35.10	30.00	7 LOAD, 13 POS.
30.10	25.00	6 LOAD, 11 POS.
25.10	20.00	5 LOAD, 9 POS.
20.10	15.00	4 LOAD, 7 POS.
15.10	10.00	3 LOAD, 5 POS.
10.10	5.00	2 LOAD, 3 POS.

THIS DRAWING IS A CONTROLLED DOCUMENT.		DWN WINTER WANG	12NOV2012	TE Connectivity	
DIMENSIONS: mm		CHK HAPYE WU	12NOV2012		
TOLERANCES UNLESS OTHERWISE SPECIFIED:		APVD YUHHONG MAO	12NOV2012	NAME RAST 2.5 TAB HEADER ASSY, SELECTIVE LOADED, TH, VERTICAL, EXTERNAL LOCKING	
0 PLC ±	1 PLC ±	PRODUCT SPEC 108-106079		SIZE A2	CAGE CODE 00779
2 PLC ±0.20	3 PLC ±	APPLICATION SPEC		DRAWING NO C-1971921	RESTRICTED TO
4 PLC ±	ANGLES ±°	WEIGHT		SCALE NTS	
FINISH		CUSTOMER DRAWING		SHEET 1	OF 5
				REV A9	

THIS DRAWING IS UNPUBLISHED. RELEASED FOR PUBLICATION 20  
 © COPYRIGHT 20 BY - ALL RIGHTS RESERVED.

LOC	DIST	REVISIONS					
ES	00	P	LTR	DESCRIPTION	DATE	DWN	APVD
		-		SEE SHEET 1	-	-	-

QTY	TAB CONTACT	QTY	HOUSING	POS.	TE PART NO.
8	TAB CONTACT w/ SILVER PLATING	1	RAST 2.5 TAB HEADER HOUSING, EXTERNAL LOCKING, 15P (SEE THE DETAIL LAYOUT ON SHEET 3)	15	3-1971924-5 2-1971924-5 1-1971924-5
7		1		13	1-1971924-3
6		1		11	2-1971924-1 1-1971924-1
5		1	RAST 2.5 TAB HEADER HOUSING, EXTERNAL LOCKING, 9P (SEE THE DETAIL LAYOUT ON SHEET 3)	9	6-1971923-9 5-1971923-9 4-1971923-9 3-1971923-9 2-1971923-9 1-1971923-9
4		1		7	8-1971923-7 7-1971923-7 6-1971923-7 5-1971923-7 4-1971923-7 3-1971923-7 2-1971923-7 1-1971923-7
3		1		5	6-1971923-5 5-1971923-5 4-1971923-5 3-1971923-5 2-1971923-5 1-1971923-5
2		1		3	1971923-3 9-1971923-3 8-1971923-3 7-1971923-3 6-1971923-3 5-1971923-3 4-1971923-3 3-1971923-3 2-1971923-3 1-1971923-3

QTY	TAB CONTACT	QTY	HOUSING	POS.	TE PART NO.
8	TAB CONTACT w/ TIN PLATING	1	RAST 2.5 TAB HEADER HOUSING, EXTERNAL LOCKING, 15P (SEE THE DETAIL LAYOUT ON SHEET 3)	15	3-1971922-5 2-1971922-5 1-1971922-5
7		1		13	1-1971922-3
6		1		11	2-1971922-1 1-1971922-1
5		1	RAST 2.5 TAB HEADER HOUSING, EXTERNAL LOCKING, 9P (SEE THE DETAIL LAYOUT ON SHEET 3)	9	6-1971921-9 5-1971921-9 4-1971921-9 3-1971921-9 2-1971921-9 1-1971921-9
4		1		7	8-1971921-7 7-1971921-7 6-1971921-7 5-1971921-7 4-1971921-7 3-1971921-7 2-1971921-7 1-1971921-7
3		1		5	9-1971921-5 8-1971921-5 7-1971921-5 6-1971921-5 5-1971921-5 4-1971921-5 3-1971921-5 2-1971921-5 1-1971921-5
2		1		3	1971921-3 9-1971921-3 8-1971921-3 7-1971921-3 6-1971921-3 5-1971921-3 4-1971921-3 3-1971921-3 2-1971921-3 1-1971921-3

THIS DRAWING IS A CONTROLLED DOCUMENT. 29MAY2012

DWN BOB YANG 12NOV2012	 <b>TE Connectivity</b>
CHK HAPYE WU 12NOV2012	
APVD YUHHONG MAO 12NOV2012	
PRODUCT SPEC	
APPLICATION SPEC	NAME RAST 2.5 TAB HEADER ASSY, SELECTIVE LOADED, TH, VERTICAL, EXTERNAL LOCKING
WEIGHT	SIZE A2 CAGE CODE 00779 DRAWING NO C-1971921 RESTRICTED TO -
CUSTOMER DRAWING	SCALE NTS SHEET 2 OF 5 REV A9

DIMENSIONS: mm TOLERANCES UNLESS OTHERWISE SPECIFIED:

0 PLC	±
1 PLC	±
2 PLC	±0.20
3 PLC	±
4 PLC	±
ANGLES	±1°
FINISH	

LOC	DIST	REVISIONS			
P	LYR	DESCRIPTION	DATE	OWN	APVD
-	-	SEE SHEET 1	-	-	-

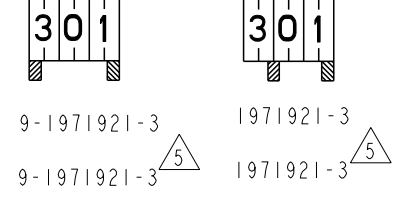
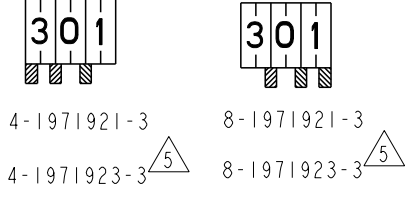
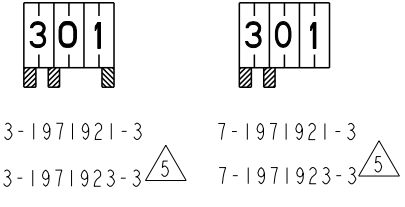
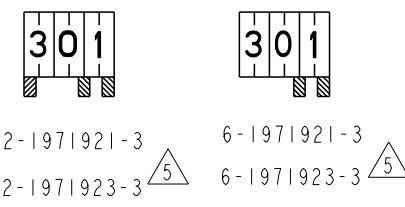
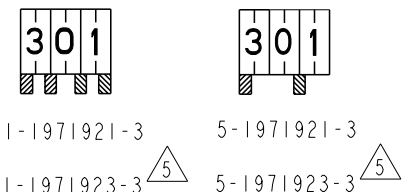

3 POS

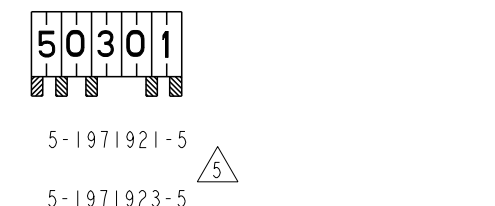
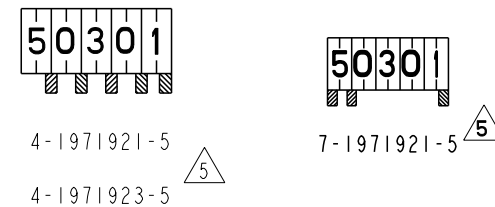
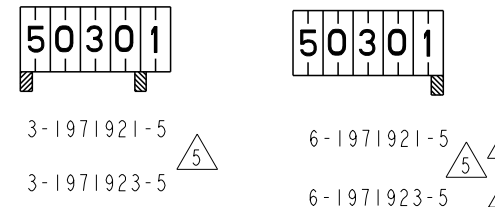
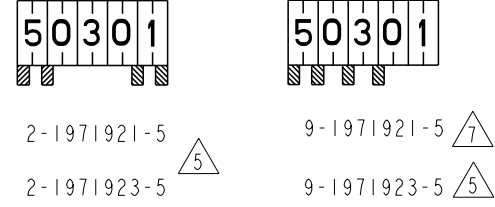
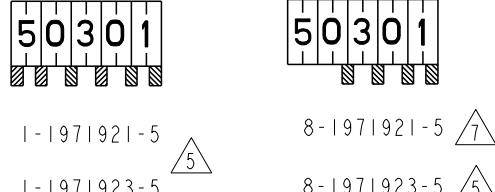

5 POS

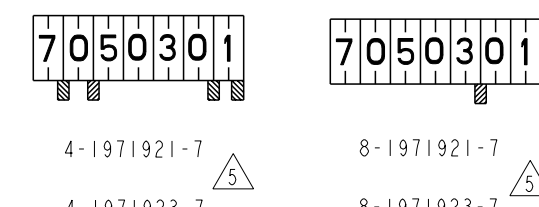
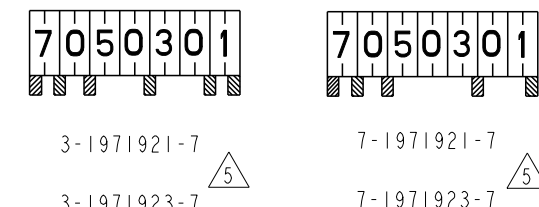
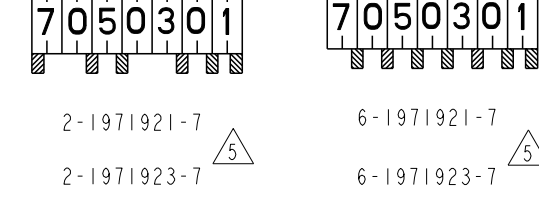
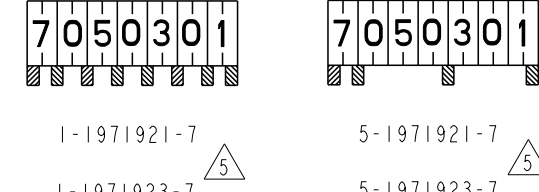

7 POS

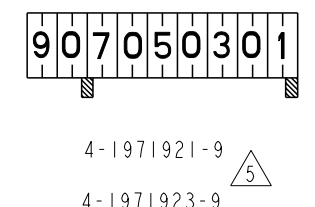
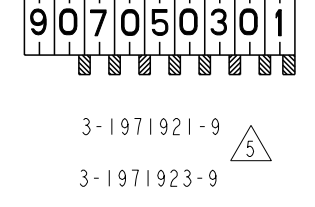
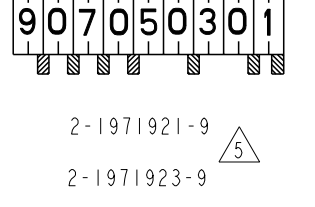
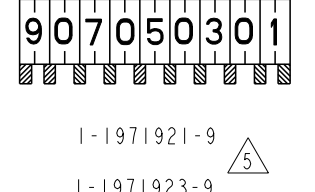

9 POS

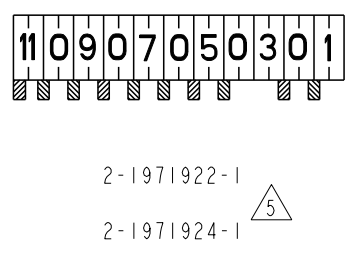
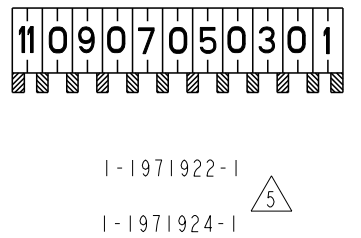

11 POS

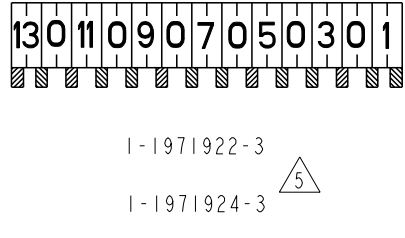

13 POS

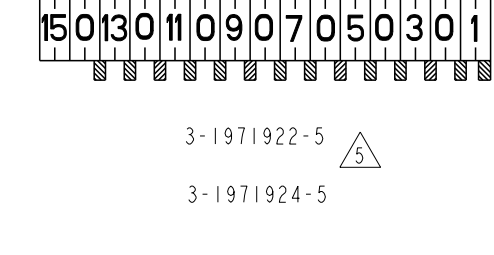
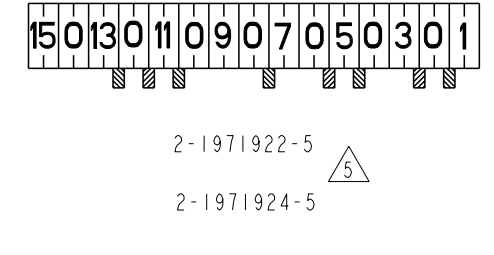
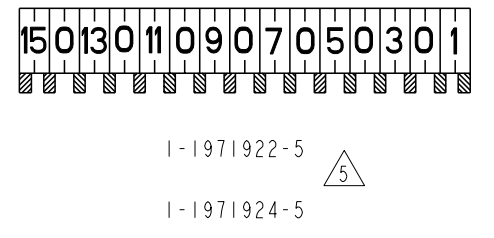

15 POS

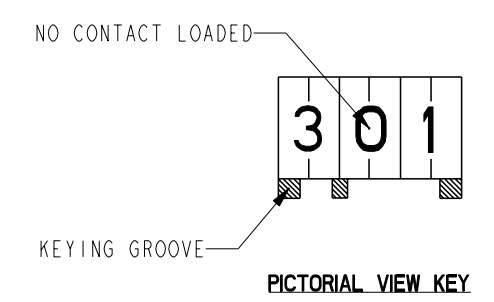

THIS DRAWING IS A CONTROLLED DOCUMENT.		OWN BOB YANG	12NOV2012	<b>STE</b> TE Connectivity
DIMENSIONS: mm		CHK HAPYE WU	12NOV2012	
TOLERANCES UNLESS OTHERWISE SPECIFIED:		APVD YUHONG MAO	12NOV2012	NAME RAST 2.5 TAB HEADER ASSY SELECTIVE LOADED, TH, VERTICAL, EXTERNAL LOCKING
0 PLC ±	1 PLC ±	PRODUCT SPEC		SIZE A1
2 PLC ±0.20	3 PLC ±	APPLICATION SPEC		CAGE CODE 00779
4 PLC ±	ANGLES ±°	WEIGHT		DRAWING NO C=1971921
FINISH		CUSTOMER DRAWING		RESTRICTED TO -
SCALE NTS			SHEET 3	OF 5
			REV A	9

LOC	DIST	REVISIONS					
		P	LYR	DESCRIPTION	DATE	OWN	APVD
-	-	-	-	SEE SHEET 1	-	-	-

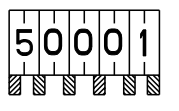

1-2825332-5

**5 POS**

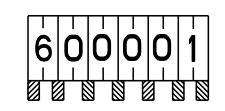

1-2825332-6

**6 POS**

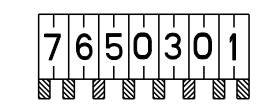

1-2825332-7

**7 POS**

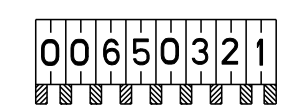

1-2825332-8

**8 POS**

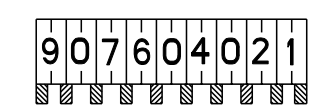

1-2825332-9

**9 POS**

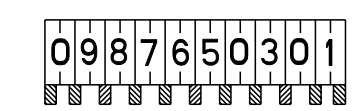

1-2825332-0

**10 POS**

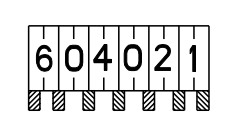

2-2825332-6

**6 POS**

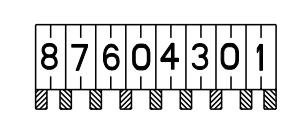

2-2825332-8

**8 POS**

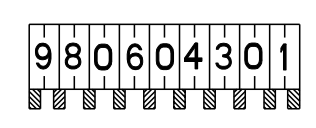

2-2825332-9

**9 POS**

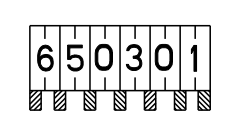

3-2825332-6

**6 POS**

PRELIMINARY PART - NOT RELEASED FOR PRODUCTION  
 PART NUMBERS X-2825332-X ARE EQUIVALENT TO #-1971921-# IN GEOMETRY AND MATERIAL,  
 WITH ADDITIONAL POSITIONS, CONTACT LOADING AND POLARIZATIONS, AS SHOWN.

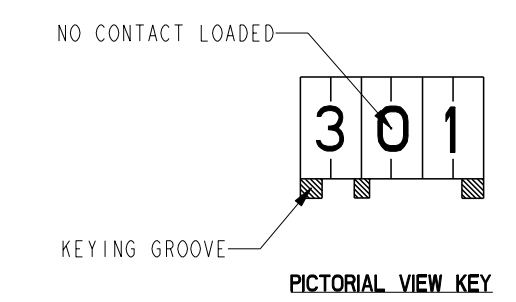

THIS DRAWING IS A CONTROLLED DOCUMENT.		OWN BOB YANG 12NOV2012	TE Connectivity RAST 2.5 TAB HEADER ASSY SELECTIVE LOADED, TH, VERTICAL, EXTERNAL LOCKING	
DIMENSIONS: mm		CHK HAPYE WU 12NOV2012		
TOLERANCES UNLESS OTHERWISE SPECIFIED:		APVD YUHONG MAO 12NOV2012	NAME	
0 PLC	±	PRODUCT SPEC	SIZE	
1 PLC	±	APPLICATION SPEC	CAGE CODE	
2 PLC	±0.20		DRAWING NO	
3 PLC	±		RESTRICTED TO	
4 PLC	±		A1 00779 C=1971921	
ANGLES	±°		SCALE	
FINISH	-		SHEET 4 OF 5	
MATERIAL	-		REV A9	
		CUSTOMER DRAWING	NTS	

THIS DRAWING IS UNPUBLISHED. RELEASED FOR PUBLICATION 20  
 © COPYRIGHT 20 BY - ALL RIGHTS RESERVED.

REVISIONS							
LOC	DIST	P	LTR	DESCRIPTION	DATE	DWN	APVD
-	-	-	-	SEE SHEET 1	-	-	-

FOR ANY KEYING CONFIGURATION, THERE ARE EIGHT COLORS AVAILABLE, BESIDES THE NATURAL COLOR, THERE ARE OTHER SEVEN COLORS, INCLUDE: YELLOW, BLUE, GREY, PURPLE, RED, GREEN, BLACK. THE WHITE VERSION IS PRELIMINARY. THE P/N OF THE COLOR CONNECTOR ARE BASED ON THE NATURAL CONNECTOR, THE PREFIX AND POSTFIX ARE THE SAME FOR THE SAME KEYING CONFIGURATION, BUT THE BASE NUMBERS ARE DIFFERENT ACCORDING TO DIFFERENT COLOR. THE FOLLOWING SHOWS WHAT'S THE P/N FOR COLOR CONNECTOR

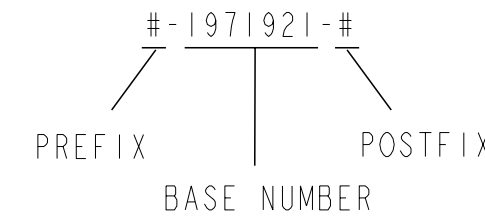

COLOR	PART NUMBER OF THE CONNECTOR				COMMENTS
	WITH TIN PLATING CONTACT		WITH AG PLATING CONTACT		
NATURAL	#-1971921-#	#-1971922-#	#-1971923-#	#-1971924-#	THE DETAIL P/N FOR DIFFERENT KEYING SEE SHEET 2 & 3
RED	#-2232189-#	#-2232190-#	#-2232191-#	#-2232192-#	THE PREFIX AND POSTFIX ARE THE SAME WITH THE P/N OF THE NATURAL CONNECTOR FOR THE SAME KEYING CONFIGURATION, JUST THE BASE NUMBERS ARE DIFFERENT BASED ON DIFFERENT COLOR. # CAN BE THE NUMBER FROM 0 TO 9.
BLUE	#-1971984-#	#-1971985-#	#-2232193-#	#-2232194-#	
YELLOW	#-2232195-#	#-2232196-#	#-2232197-#	#-2232198-#	
BALCK	#-2232199-#	#-2232200-#	#-2232201-#	#-2232202-#	
GREY	#-2232203-#	#-2232204-#	#-2232205-#	#-2232206-#	
GREEN	#-2232207-#	#-2232208-#	#-2232209-#	#-2232210-#	
PURPLE	#-2232211-#	#-2232212-#	#-2232213-#	#-2232214-#	
WHITE	#-2232285-#	#-2232286-#	#-2232287-#	#-2232288-#	

FOR EXAMPLE, IF A CONNECTOR WITH THE CONFIGURATION AS BELOW, AND WITH TIN PLATING CONTACT, IN THE SHEET 4, WE CAN FIND THE RELATED CONNECTOR P/N WITH NATURAL COLOR IS 3-1971921-3, THEN WE CAN LOOK IN THE ABOVE TABLE TO FIND THE CONNECTOR P/N WITH RED COLOR IS 3-2232189-3

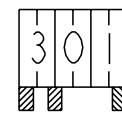

THIS DRAWING IS A CONTROLLED DOCUMENT.		DWN: 12NOV2012 WINTER WANG	TE Connectivity	
DIMENSIONS: mm		CHK: 12NOV2012 HAPYE WU		
TOLERANCES UNLESS OTHERWISE SPECIFIED:		APVD: 12NOV2012 YUHONG MAO	NAME: RAST 2.5 TAB HEADER ASSY SELECTIVE LOADED, TH, VERTICAL, EXTERNAL LOCKING	
0 PLC ± 1 PLC ± 2 PLC ±0.2 3 PLC ± 4 PLC ±		PRODUCT SPEC: -	SIZE: A2	CAGE CODE: 00779
ANGLES ±° FINISH		APPLICATION SPEC: -	DRAWING NO: C-1971921	RESTRICTED TO: -
MATERIAL: -		WEIGHT: -	SCALE: 5:1 SHEET 5 OF 5 REV A9	
Customer Drawing				

## X-ON Electronics

Largest Supplier of Electrical and Electronic Components

*Click to view similar products for [Headers & Wire Housings](#) category:*

*Click to view products by [TE Connectivity](#) manufacturer:*

Other Similar products are found below :

[892-18-020-10-001101](#) [58102-G61-06LF](#) [582553-1](#) [0009485154](#) [009176003701906](#) [0050291907](#) [LY20-4P-DT1-P1E-BR](#) [02.125.8002.8](#)  
[609-3404](#) [61062-3](#) [61082-181009](#) [622-3653LF](#) [63453-116](#) [636-1030](#) [636-1427](#) [636-3427](#) [636-4007](#) [641938-9](#) [641991-4](#) [644827-2](#) [65817-](#)  
[010LF](#) [65817-015LF](#) [65863-015LF](#) [66207-023LF](#) [67095-007LF](#) [67601157](#) [68645-018](#) [68648-049](#) [70.362.1628.0](#) [70-4210](#) [70-4226B](#) [70-](#)  
[4853B](#) [707-5020](#) [707-5028](#) [71.350.2428.0](#) [71918-208LF](#) [71961-016LF](#) [733-134](#) [733-162](#) [754199-000](#) [760-3052](#) [787-8014-00](#) [79531-3000](#)  
[FCN-360C032-B](#) [FCN-367T-T012/H](#) [FCN-723D010/2](#) [80.063.4001.1](#) [800-90-001-10-001000](#) [800-90-010-10-002000](#) [801-43-002-10-013000](#)