

RGW RING LUG TERMINAL BLOCKS

Stud technology

ENTRELEC Terminal Blocks

RGW Ring lug terminal blocks

Stud technology

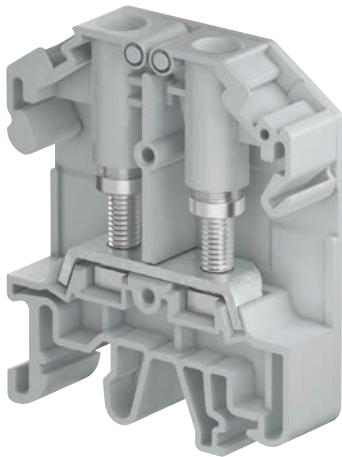

Fast and secured wiring for ring lugs

The RGW terminal blocks offer a combination of fast and secured wiring. Thanks to its exceptional design, the nuts are captive in a pivoting wing and provide a convenient wiring of ring lugs.

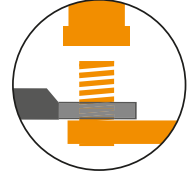

CE IEC cULus SP RoHS



Speed up your processes

Fast ring lug connection

- 45% faster than open style terminal blocks thanks to captive and ready to tighten nuts
- No need to remove the nuts for the first use
- Easy 3 steps wiring.

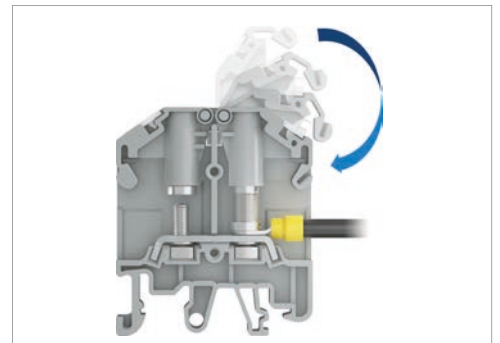

Security and protection

Secured wiring

- 100% captive wire connection: optimal combination of stud, safety wings, captive nut and ring lug
- Self-locking wings to prevent sudden opening
- Touch proof design.

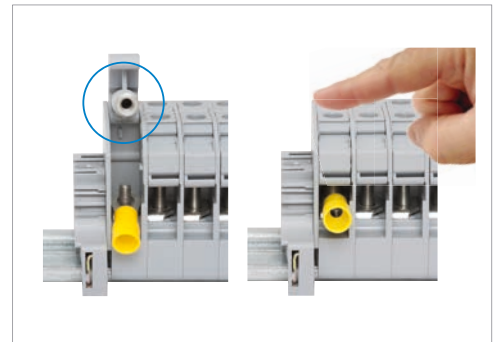

Improve installation efficiency

Convenient installation

- 15% more compact: save space on the DIN Rail versus open style terminal blocks
- Universal foot for mounting on symmetrical and asymmetrical DIN Rails.

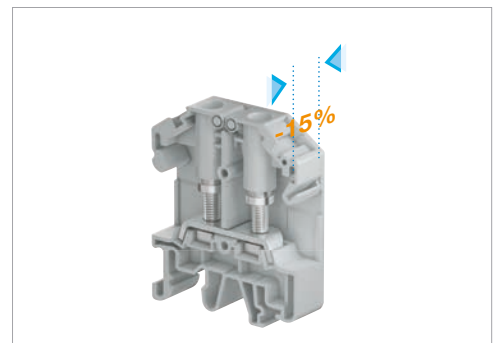

15N16602050201

Features

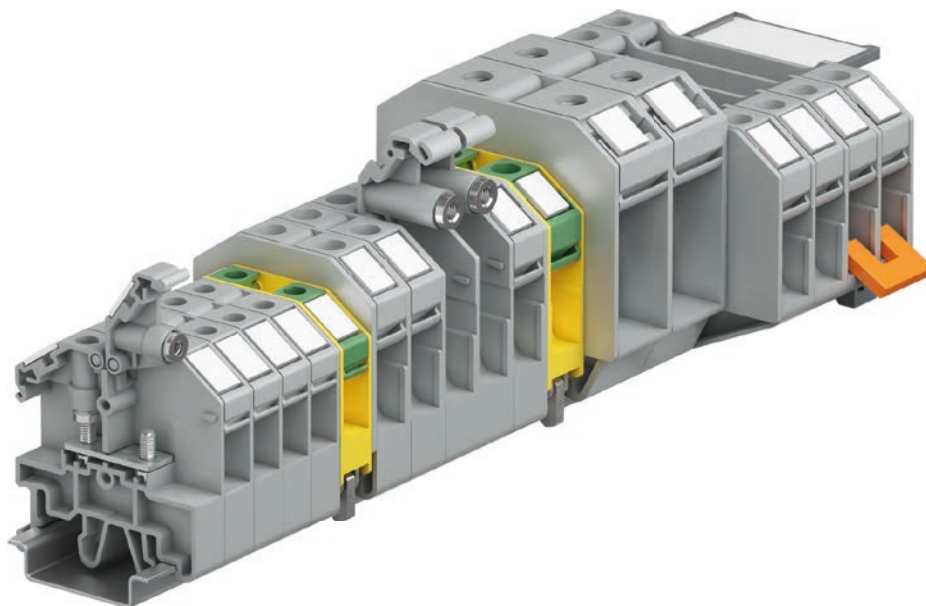
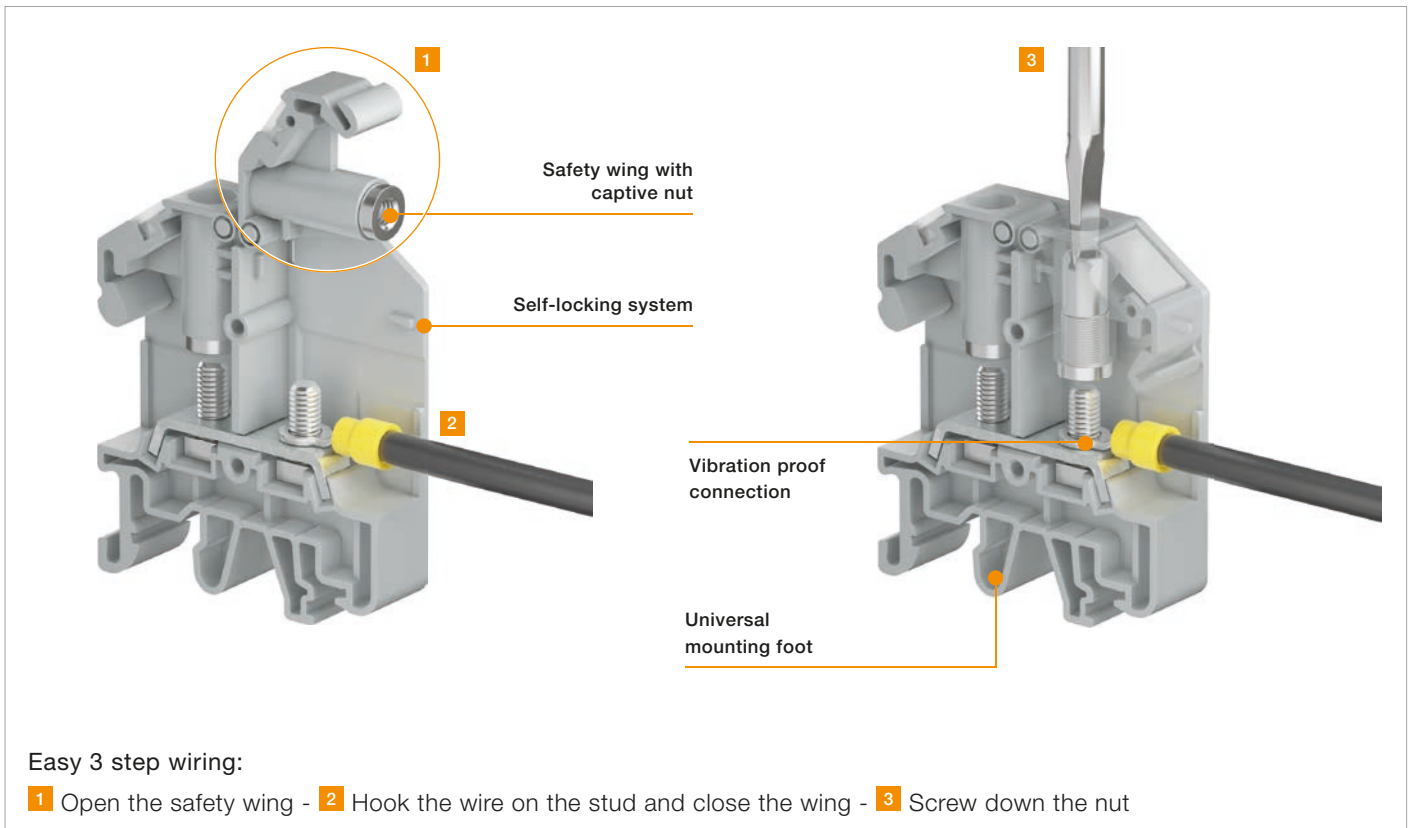

RGW Ring lug terminal blocks

Stud technology - Range overview from 2.5 to 25 mm² - 14 to 4 AWG

2.5 mm² 14 AWG

Feed-through
Feed-through
with test sockets
Ground

6 mm² 10 AWG

Feed-through
Feed-through
with test sockets
Ground

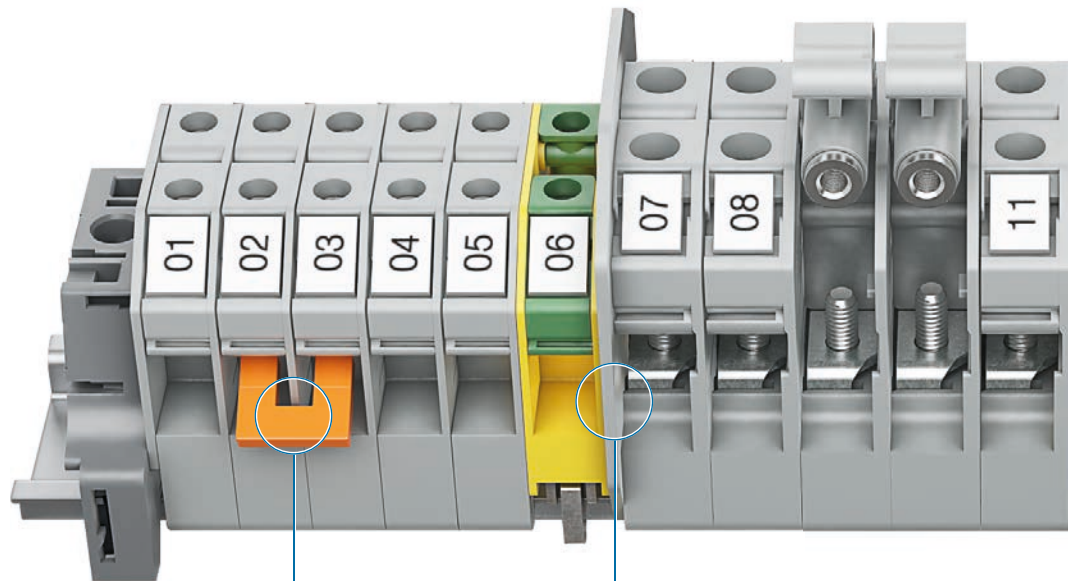

Jumper bars
from 2 to 10 poles

Convenient circuit separator
circuit & voltage separation

15NC164023S200

25 mm² 4 AWG

Feed-through

6 mm² 10 AWG

Feed-through with test sockets

Disconnect with sliding link

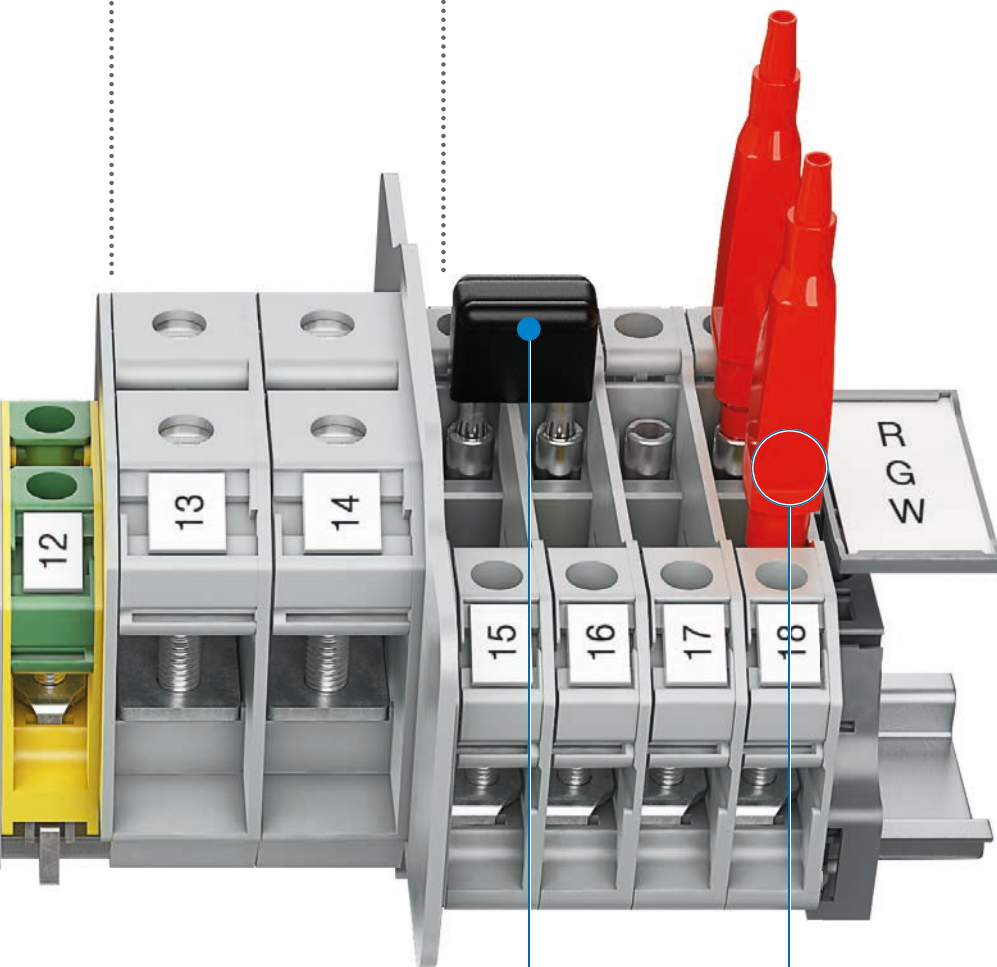

Easy CT short circuiting
with short-circuit plug

Convenient testing
test sockets compatible with
DIA 4 mm test plugs

RGW Ring lug terminal blocks

Applications & certifications

Qualified for worldwide markets, applications and for severe environments: vibration, shock...

Industry



Ring lug technology is a long time approved technology in the industry (i.e semi conductor production line) for it's proven reliability. The 100% captive connection secures the wiring.

Utility



Thanks to a 100% captive connection our RGW terminal blocks are well adapted to the power, medium and low voltage switchgear panels where a full secured connection is required.

HVAC



RGW terminal blocks are well adapted to HVAC application requesting ring lug terminals providing at the same time a vibration proof connection and increased productivity.



RoHS



1SNC166023S0201

Railway



Rail vehicles are subjected to extreme environmental conditions. RGW terminal blocks are part of the ENTRELEC railway terminal blocks offering, the largest of the market. RGW terminal blocks are tested in accordance with the latest and most demanding standards applying to rolling stock applications.

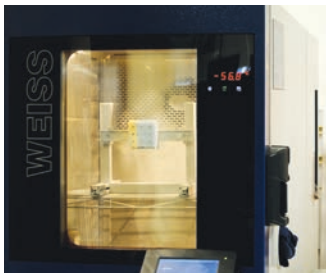

IEC 61373 Railway applications – Rolling stock equipment – Shock and vibration tests
RGW terminal blocks are complying with **category 1 (body mounted) class B**.

EN 45545-2 Railway applications. Fire protection on railway vehicles. Requirements for fire behavior of materials and components

RGW terminal blocks plastic materials are rated **HL3 R22 (the highest Hazard level)**. They can be used on vehicles for subway, tube, sleeping and couchette.

NF F 16-101 Directive relative to selecting materials in relation to their fire resistance in terms of its behavior in a fire, the opacity of smoke and the toxicity of the gas released.

NF F 16-102 Complement to NF F 16-101. The purpose of this standard is to specify the application of NF F 16-101 to electrical equipment and especially to individual apparatus.

RGW terminal blocks plastic materials are rated **I2F2. Level 3**. This level concern products mounted inside a room for passengers or running crew.

IEC 60068-2.1/IEC 60068-2.2/IEC 60068-2.78/IEC 60068-2.30 : Environmental test

RGW terminal blocks have successfully passed the damp heat, dry heat, cold climatic test.

UL94 (North America) Standard for Safety of Flammability of Plastic Materials for Parts in Devices and Appliances testing

RGW terminal blocks plastic materials are rated **UL94 V0**.



RGW2.5 Ring lug terminal blocks

Feed-through - 9 mm 0.354 in spacing

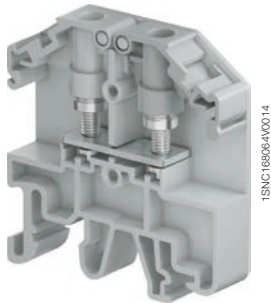

RGW2.5

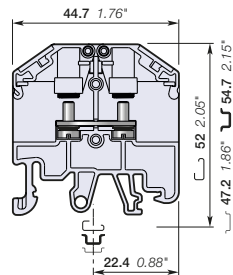

9 mm 0.354 in spacing

Description

- Stud terminal block for ring lug connection,
- Integrated captive nuts in protective wings provide easy and secured connection,
- Universal mounting on symmetrical and asymmetrical rails.

Ordering details

Description	Color	Type	Part Numbers	Pkg qty	Weight (1 pce) g
Feed-through With 2 studs M3 and captive nuts in wings	Grey <input type="checkbox"/>	RGW2.5-V0	1SNA510003R0000	45	11.78

Main technical data

Lugs	Rigid: Solid/Stranded Flexible with insulated ferrule Gauge	IEC	UL	CSA
		0.1 ... 2.5 mm ²	26 ... 14 AWG	26 ... 14 AWG
Rated current		24 A	15 A	20 A
Maximum current			20 A	
Rated cross section	2.5 mm ²		14 AWG	14 AWG
Rated short-time withstand current (1s)	300 A			
Rated voltage	800 V	600 V	600 V	
Impulse withstand voltage	8000 V			
Protection	IP10	NEMA 1		

Mounting instructions

Rail		G32, TH 35-7.5, TH 35-15
Nuts		Flat screwdriver Ø 4 mm Ø 0.157 in
Tool		
Torque		0.6 ... 0.8 N.m 5.3 ... 7.1 lb.in
Max width of lug		7 mm 0.28 in

The connecting capacity data for one Rigid: Solid/Stranded, or one Flexible conductor (when applicable) is a mandatory information required by IEC, UL and CSA standards (Copper conductors). All other data are provided as supplementary information only. For more details, please consult our CB, UL or CSA certificates and technical datasheet available on <http://www.TE.com>

CE	RoHS	UL	CSA

Accessories

Description	Color	Type	Part Numbers	Pkg qty	Weight (1 pce) g	
1 End stops 10 mm 0.394 in	Dark grey <input type="checkbox"/>	BAM4	1SNK900001R0000	50	14.00	
2 End sections 1.2 mm 0.047 in	Grey <input type="checkbox"/>	E-RGW2.5	1SNA519003R0000	25	1.89	
3 Lateral jumper bars	Orange <input type="checkbox"/>	2 poles 24 A (IEC)	PC-RG2.5-2	1SNA519103R0200	25	3.02
		3 poles 24 A (IEC)	PC-RG2.5-3	1SNA519103R0300	20	4.69
		4 poles 24 A (IEC)	PC-RG2.5-4	1SNA519103R0400	15	6.36
		10 poles 24 A (IEC)	PC-RG2.5-10	1SNA519103R1000	5	16.39
4 Circuit separators 1.5 mm 0.059 in	Grey <input type="checkbox"/>	CS-RGW-S	1SNA519200R0000	25	4.59	
5 Terminal block markers	White <input type="checkbox"/>	M-W610PC	1SNA235511R0600	360	8.03	
		MG-CPM-01 41090	1SNB041090R0510	1960	0.351	

Complete list of accessories is indicated in the terminal block datasheet including end stops.

Some accessories such as jumper bars may modify the terminal block's ratings: Complete information available in the accessories section of the catalog.

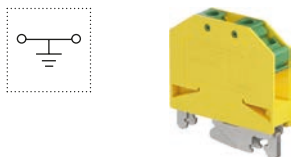

Ground Ring lug terminal blocks

Description	Color	Type	Part Numbers	Pkg qty	Weight (1 pce) g
Ground With 2 studs M3 and captive nuts in wings	Green-yellow <input type="checkbox"/>	RGW2.5-PE-V0	1SNA511003R0500	45	28.56

Technical data valid for copper conductors only.

RGW2.5-T Ring lug terminal blocks

Feed-through with test sockets - 9 mm 0.354 in spacing

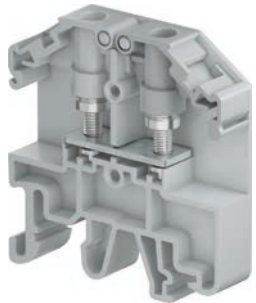

RGW2.5-T

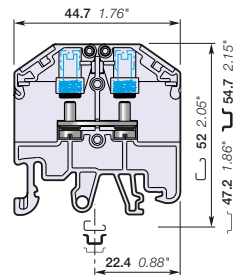

9 mm 0.354 in spacing

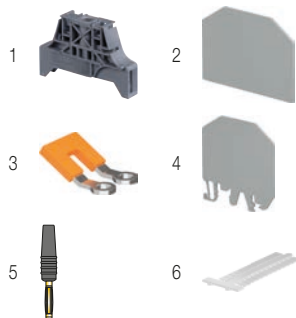

Description

- Stud terminal block for ring lug connection,
- Integrated captive nuts in protective wings provide easy and secured connection,
- Ease your test operations with the 2 built-in nuts with test sockets compatible with DIA 2 mm 0.079 in,
- Universal mounting on symmetrical and asymmetrical rails.

Ordering details

Description	Color	Type	Part Number	Pkg qty	Weight (1 pce) g
Feed-through With 2 studs M3 and captive nuts in wings	Grey <input type="checkbox"/>	RGW2.5-T-V0	1SNA510103R0000	45	11.58

Main technical data

	IEC	UL	CSA
Lugs	Rigid: Solid/Stranded Flexible with insulated ferrule Gauge	0.1 ... 2.5 mm ² 0.1 ... 2.5 mm ²	26 ... 14 AWG 26 ... 14 AWG
Rated current	24 A	15 A	20 A
Maximum current		20 A	
Rated cross section	2.5 mm ²	14 AWG	14 AWG
Rated short-time withstand current (1s)	300 A		
Rated voltage	800 V	600 V	600 V
Impulse withstand voltage	8000 V		
Protection	IP10	NEMA 1	

Mounting instructions

Rail		G32, TH 35-7.5, TH 35-15
Nuts		Flat screwdriver Ø 4 mm Ø 0.157 in
Tool		
Torque		0.6 ... 0.8 N.m 5.3 ... 7.1 lb.in
Max width of lug		7 mm 0.28 in

The connecting capacity data for one Rigid: Solid/Stranded, or one Flexible conductor (when applicable) is a mandatory information required by IEC, UL and CSA standards (Copper conductors). All other data are provided as supplementary information only. For more details, please consult our CB, UL or CSA certificates and technical datasheet available on <http://www.TE.com>

--	--	--	--

Accessories

Description	Color	Type	Part Number	Pkg qty	Weight (1 pce) g
1 End stops	Dark grey <input checked="" type="checkbox"/>	BAM4	1SNK900001R0000	50	14.00
2 End sections	Grey <input type="checkbox"/>	E-RGW2.5	1SNA519003R0000	25	1.89
3 Lateral jumper bars	Orange <input checked="" type="checkbox"/>	PC-RG2.5-2	1SNA519103R0200	25	3.02
		PC-RG2.5-3	1SNA519103R0300	20	4.69
		PC-RG2.5-4	1SNA519103R0400	15	6.36
		PC-RG2.5-10	1SNA519103R1000	5	16.39
4 Circuit separators	Grey <input type="checkbox"/>	CS-RGW-S	1SNA519200R0000	25	4.59
5 Test plugs	Black <input checked="" type="checkbox"/>	FC2.MC	1SNA107239R0300	20	1.00
6 Terminal block markers	White <input type="checkbox"/>	M-W610PC	1SNA235511R0600	360	8.03
		MG-CPM-01 41090	1SNB041090R0510	1960	0.351

Complete list of accessories is indicated in the terminal block datasheet including end stops.

Some accessories such as jumper bars may modify the terminal block's ratings: Complete information available in the accessories section of the catalog.

Ground Ring lug terminal blocks

Description	Color	Type	Part Number	Pkg qty	Weight (1 pce) g
Ground With 2 studs M3 and captive nuts in wings	Green-yellow <input checked="" type="checkbox"/>	RGW2.5-PE-V0	1SNA511003R0500	45	28.56

Technical data valid for copper conductors only.

RGW6 Ring lug terminal blocks

Feed-through - 11 mm 0.433 in spacing

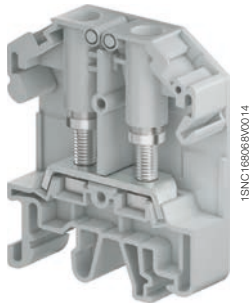

RGW6

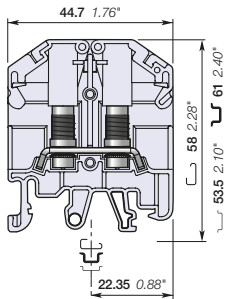

11 mm 0.433 in spacing

Description

- Stud terminal block for ring lug connection,
- Integrated captive nuts in protective wings provide easy and secured connection,
- Universal mounting on symmetrical and asymmetrical rails.

Ordering details

Description	Color	Type	Part Numbers	Pkg qty	Weight (1 pce) g
Feed-through With 2 studs M4 and captive nuts in wings	Grey <input type="checkbox"/>	RGW6-V0	1SNA510024R0000	40	19.76

Main technical data

Lugs	Rigid: Solid/Stranded Flexible with insulated ferrule Gauge	IEC	UL	CSA
		0.1 ... 6 mm²	22 ... 10 AWG	22 ... 10 AWG
Rated current		41 A	30 A	30 A
Maximum current			30 A	
Rated cross section	6 mm²		10 AWG	10 AWG
Rated short-time withstand current (1s)	720 A			
Rated voltage	800 V	600 V	600 V	
Impulse withstand voltage	8000 V			
Protection	IP10	NEMA 1		

Mounting instructions

Rail		G32, TH 35-7.5, TH 35-15
Nuts		Flat screwdriver Ø 5.5 mm Ø 0.217 in
Tool		
Torque		0.8 ... 1.2 N.m 7.1 ... 10.6 lb.in
Max width of lug		9.4 mm 0.37 in

The connecting capacity data for one Rigid: Solid/Stranded, or one Flexible conductor (when applicable) is a mandatory information required by IEC, UL and CSA standards (Copper conductors). All other data are provided as supplementary information only. For more details, please consult our CB, UL or CSA certificates and technical datasheet available on <http://www.TE.com>

CE	RoHS	UL US ULS CNR	CSA

Accessories

Description	Color	Type	Part Numbers	Pkg qty	Weight (1 pce) g
1 End stops 10 mm 0.394 in	Dark grey <input type="checkbox"/>	BAM4	1SNK900001R0000	50	14.00
2 End sections 1.4 mm 0.055 in	Grey <input type="checkbox"/>	E-RGW6	1SNA519004R0000	50	2.65
3 Lateral jumper bars 2 poles 41 A (IEC)	Orange <input type="checkbox"/>	PC-RG6-2	1SNA519104R0200	25	3.44
3 poles 41 A (IEC)		PC-RG6-3	1SNA519104R0300	20	5.40
4 poles 41 A (IEC)		PC-RG6-4	1SNA519104R0400	15	7.33
7 poles 41 A (IEC)		PC-RG6-7	1SNA519104R0700	5	13.24
10 poles 41 A (IEC)		PC-RG6-10	1SNA519104R1000	5	19.05
4 Circuit separators 1.5 mm 0.059 in	Grey <input type="checkbox"/>	CS-RGW-S	1SNA519200R0000	25	4.59
5 Terminal block markers	White <input type="checkbox"/>	M-W810PC	1SNA235510R0800	260	0.27
		MG-CPM-01 41096	1SNB041096R0810	1120	0.400

Complete list of accessories is indicated in the terminal block datasheet including end stops.

Some accessories such as jumper bars may modify the terminal block's ratings: Complete information available in the accessories section of the catalog.

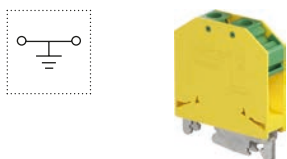

Ground Ring lug terminal blocks

Description	Color	Type	Part Numbers	Pkg qty	Weight (1 pce) g
Ground With 2 studs M4 and captive nuts in wings	Green-yellow <input type="checkbox"/>	RGW6-PE-V0	1SNA511024R0500	40	31.76

Technical data valid for copper conductors only.

RGW25-M5 Ring lug terminal blocks

Feed-through - 18 mm 0.709 in spacing

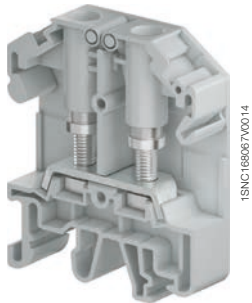

RGW25-M5

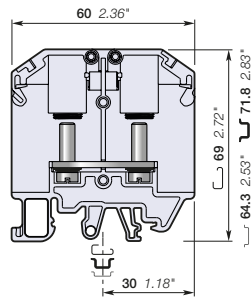

18 mm 0.709 in spacing

Description

- Stud terminal block for ring lug connection,
- Integrated captive nuts in protective wings provide easy and secured connection,
- Universal mounting on symmetrical and asymmetrical rails.

Ordering details

Description	Color	Type	Part Numbers	Pkg qty	Weight (1 pce) g
Feed-through With 2 studs M5 and captive nuts in wings	Grey <input type="checkbox"/>	RGW25-M5-V0	1SNA510005R0000	10	49.10

Main technical data

Lugs	Rigid: Solid/Stranded Flexible with insulated ferrule Gauge	IEC	UL	CSA
		0.1 ... 25 mm²	26 ... 4 AWG	26 ... 4 AWG
Rated current		101 A	85 A	100 A
Maximum current			115 A	
Rated cross section	25 mm²		4 AWG	4 AWG
Rated short-time withstand current (1s)	3000 A			
Rated voltage	800 V	600 V	600 V	
Impulse withstand voltage	8000 V			
Protection	IP10	NEMA 1		

Mounting instructions

Rail		G32, TH 35-7.5, TH 35-15
Nuts		Flat screwdriver Ø 5.5 mm Ø 0.217 in
Tool		
Torque		3 ... 3.5 N.m 26.5 ... 31 lb.in
Max width of lug		16.2 mm 0.64 in

The connecting capacity data for one Rigid: Solid/Stranded, or one Flexible conductor (when applicable) is a mandatory information required by IEC, UL and CSA standards (Copper conductors). All other data are provided as supplementary information only. For more details, please consult our CB, UL or CSA certificates and technical datasheet available on <http://www.TE.com>

CE	RoHS	UL US USH CNR	CSA

Accessories

Description	Color	Type	Part Numbers	Pkg qty	Weight (1 pce) g
1 End stops 10 mm 0.394 in	Dark grey <input type="checkbox"/>	BAZH1	1SNK900102R0000	20	24.00
2 End sections 1.4 mm 0.055 in	Grey <input type="checkbox"/>	E-RGW25	1SNA519005R0000	25	0.146
3 Lateral jumper bars 2 poles 101 A (IEC)	Orange <input type="checkbox"/>	PC-RGW25-2	1SNA519106R0200	25	8.81
4 Circuit separators 2 mm 0.079 in	Grey <input type="checkbox"/>	CS-RGW-L	1SNA519201R0000	25	13.72
5 Terminal block markers	White <input type="checkbox"/>	M-W1010PC	1SNA235512R1000	200	0.10
		MG-CPM-01 41096	1SNB041096R0810	1120	0.400

Complete list of accessories is indicated in the terminal block datasheet including end stops. Some accessories such as jumper bars may modify the terminal block's ratings: Complete information available in the accessories section of the catalog.

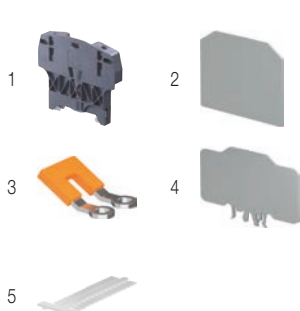

Technical data valid for copper conductors only.

RGW25-M6 Ring lug terminal blocks

Feed-through - 18 mm 0.709 in spacing

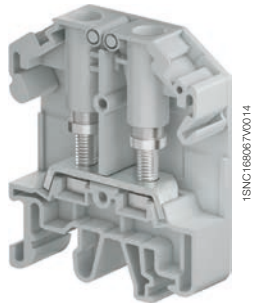

RGW25-M6

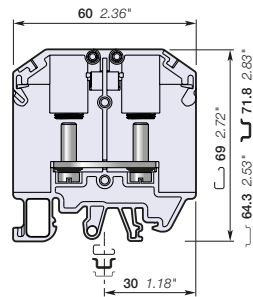

18 mm 0.709 in spacing

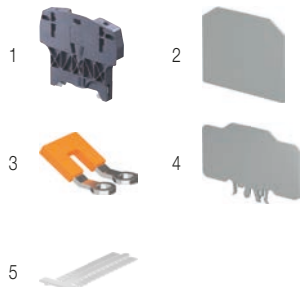

Description

- Stud terminal block for ring lug connection,
- Integrated captive nuts in protective wings provide easy and secured connection,
- Universal mounting on symmetrical and asymmetrical rails.

Ordering details

Description	Color	Type	Part Numbers	Pkg qty	Weight (1 pce) g
Feed-through With 2 studs M6 and captive nuts in wings	Grey <input type="checkbox"/>	RGW25-M6-V0	1SNA510006R0000	10	48.44

Main technical data

	IEC	UL	CSA
Lugs	Rigid: Solid/Stranded Flexible with insulated ferrule Gauge	0.1 ... 25 mm ² 0.1 ... 25 mm ²	26 ... 4 AWG 26 ... 4 AWG
Rated current	101 A	85 A	100 A
Maximum current		115 A	
Rated cross section	25 mm ²	4 AWG	4 AWG
Rated short-time withstand current (1s)	3000 A		
Rated voltage	800 V	600 V	600 V
Impulse withstand voltage	8000 V		
Protection	IP10	NEMA 1	

Mounting instructions

Rail		G32, TH 35-7.5, TH 35-15
Nuts		Flat screwdriver Ø 5.5 mm Ø 0.217 in
Tool		
Torque		3.2 ... 3.5 N.m 28.3 ... 32.7 lb.in
Max width of lug		16.2 mm 0.64 in

The connecting capacity data for one Rigid: Solid/Stranded, or one Flexible conductor (when applicable) is a mandatory information required by IEC, UL and CSA standards (Copper conductors). All other data are provided as supplementary information only. For more details, please consult our CE, UL or CSA certificates and technical datasheet available on <http://www.TE.com>

CE	RoHS	UL US	CSA

Accessories

Description	Color	Type	Part Numbers	Pkg qty	Weight (1 pce) g
1 End stops 10 mm 0.394 in	Dark grey <input checked="" type="checkbox"/>	BAZH1	1SNK900102R0000	20	24.00
2 End sections 1.4 mm 0.055 in	Grey <input type="checkbox"/>	E-RGW25	1SNA519005R0000	25	0.146
3 Lateral jumper bars 2 poles 101 A (IEC)	Orange <input type="checkbox"/>	PC-RG25-2	1SNA519106R0200	25	8.81
4 Circuit separators 2 mm 0.079 in	Grey <input type="checkbox"/>	CS-RGW-L	1SNA519201R0000	25	13.72
5 Terminal block markers	White <input type="checkbox"/>	M-W1010PC	1SNA235512R1000	200	0.10
		MG-CPM-01 41096	1SNB041096R0810	1120	0.400

Complete list of accessories is indicated in the terminal block datasheet including end stops.

Some accessories such as jumper bars may modify the terminal block's ratings: Complete information available in the accessories section of the catalog.

Technical data valid for copper conductors only.

RGW2.5-PE Ring lug terminal blocks

Ground - 10 mm 0.394 in spacing



2.5 mm²

14 AWG

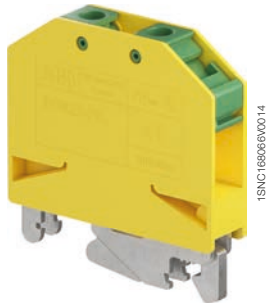

RGW2.5-PE

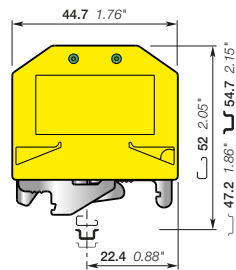

10 mm 0.394 in spacing

Description

- Stud terminal block for ring lug connection,
- Integrated captive nuts in protective wings provide easy and secured connection,
- Universal mounting on symmetrical and asymmetrical rails.

Ordering details

Description	Color	Type	Part Number	Pkg qty	Weight (1 pce) g
Ground With 2 studs M3 and captive nuts in wings	Green-yellow	RGW2.5-PE-V0	1SNA511003R0500	45	28.56

Main technical data

	IEC	UL	CSA
Lugs	Rigid: Solid/Stranded	0.1 ... 2.5 mm ²	26 ... 14 AWG
	Flexible with insulated ferrule Gauge	0.1 ... 2.5 mm ²	26 ... 14 AWG
Rated cross section	2.5 mm ²	14 AWG	14 AWG
Rated short-time withstand current (1s)	300 A		
Protection	IP10	NEMA 1	

Mounting instructions

Rail		G32, TH 35-7.5, TH 35-15
Nuts		Flat screwdriver Ø 4 mm 0.6 ... 0.8 N.m 5.3 ... 7.1 lb.in
Torque		0.6 ... 0.8 N.m 5.3 ... 7.1 lb.in
Rail connection screw		Flat screwdriver Ø 4 mm 0.5 ... 0.6 N.m 4.4 ... 5.3 lb.in
Torque		0.5 ... 0.6 N.m 4.4 ... 5.3 lb.in
Max width of lug		7 mm 0.28 in

The connecting capacity data for one Rigid: Solid/Stranded, or one Flexible conductor (when applicable) is a mandatory information required by IEC, UL and CSA standards (Copper conductors). All other data are provided as supplementary information only. For more details, please consult our CB, UL or CSA certificates and technical datasheet available on <http://www.TE.com>

--	--	--	--

Accessories

Description	Color	Type	Part Number	Pkg qty	Weight (1 pce) g
1 End stops	Dark grey	BAM4	1SNK900001R0000	50	14.00
2 Circuit separators	Grey	CS-RGW-S	1SNA519200R0000	25	4.59
3 Terminal block markers	White	M-W610PC	1SNA235511R0600	360	8.03
		MG-CPM-01 41090	1SNB041090R0510	1960	0.351

Complete list of accessories is indicated in the terminal block datasheet including end stops.

Some accessories such as jumper bars may modify the terminal block's ratings: Complete information available in the accessories section of the catalog.

Technical data valid for copper conductors only.

RGW6-PE Ring lug terminal blocks

Ground - 12 mm 0.472 in spacing

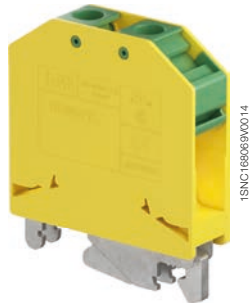
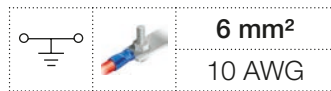

RGW6-PE

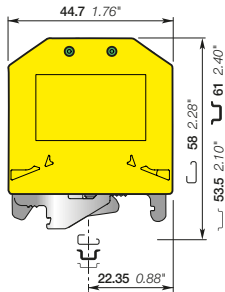

12 mm 0.472 in spacing

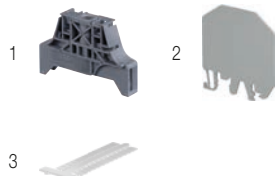

Description

- Stud terminal block for ring lug connection,
- Integrated captive nuts in protective wings provide easy and secured connection,
- Universal mounting on symmetrical and asymmetrical rails.

Ordering details

Description	Color	Type	Part Number	Pkg qty	Weight (1 pce) g
Ground With 2 studs M4 and captive nuts in wings	Green-yellow	RGW6-PE-V0	1SNA511024R0500	40	31.76

Main technical data

		IEC	UL	CSA
Lugs	Rigid: Solid/Stranded	0.1 ... 6 mm ²	22 ... 10 AWG	22 ... 10 AWG
	Flexible with insulated ferrule Gauge	0.1 ... 6 mm ²		
Rated cross section		6 mm ²	10 AWG	10 AWG
Rated short-time withstand current (1s)		720 A		
Protection		IP10	NEMA 1	

Mounting instructions

Rail		G32, TH 35-7.5, TH 35-15
Nuts		Flat screwdriver Ø 5.5 mm Ø 0.217 in
Tool		
Torque		0.8 ... 1.2 N.m 7.1 ... 10.6 lb.in
Rail connection screw		Flat screwdriver Ø 4 mm Ø 0.157 in
Tool		
Torque		0.5 ... 0.8 N.m 4.4 ... 5.3 lb.in
Max width of lug		9.4 mm 0.37 in

The connecting capacity data for one Rigid: Solid/Stranded, or one Flexible conductor (when applicable) is a mandatory information required by IEC, UL and CSA standards (Copper conductors). All other data are provided as supplementary information only. For more details, please consult our CB, UL or CSA certificates and technical datasheet available on <http://www.TE.com>

CE	RoHS	UL	CSA						

Accessories

Description	Color	Type	Part Number	Pkg qty	Weight (1 pce) g
1 End stops	Dark grey	BAM4	1SNK900001R0000	50	14.00
2 Circuit separators	Grey	CS-RGW-S	1SNA519200R0000	25	4.59
3 Terminal block markers	White	M-W810PC MG-CPM-01 41096	1SNA235510R0800 1SNB041096R0810	260 1120	0.27 0.400

Complete list of accessories is indicated in the terminal block datasheet including end stops.

Some accessories such as jumper bars may modify the terminal block's ratings: Complete information available in the accessories section of the catalog.

Technical data valid for copper conductors only.

RGW Ring lug terminal blocks

Stud technology - Test & measurement

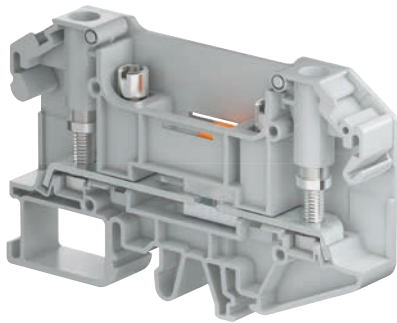

Secure your measurement operations

With its 100% captive wire connection, RGW test & measurement terminal blocks offer a safe and ergonomic test measurement operation.

High performances

- 6 mm² 10 AWG
- 41 A (IEC) 30 A (UL)
- 1000 V (IEC) 600V (UL).

Features

- Test sockets provided on every disconnect blocks RGW6-ST-1...
- Aligned feed-through version RGW6-R1... available for all types of schematics.

Typical measurement configuration

Common point on the transformers

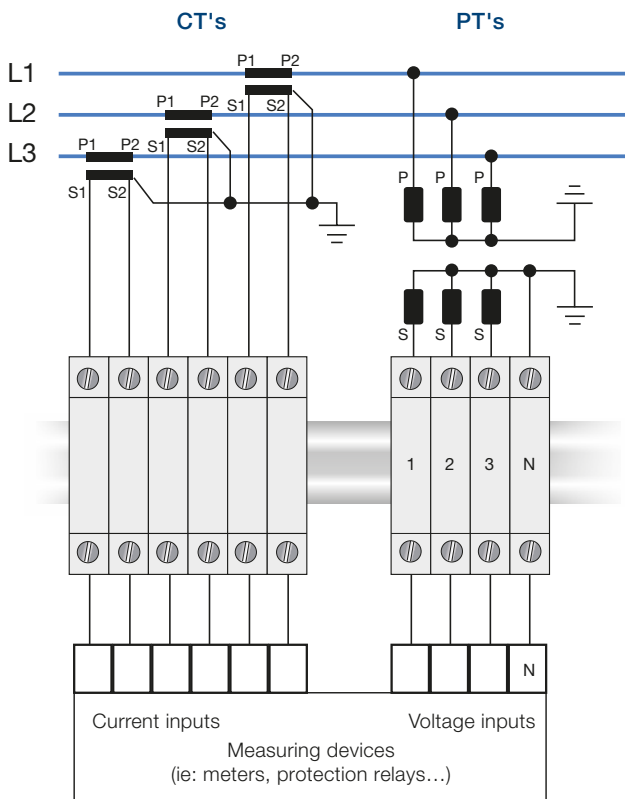

Bill of material

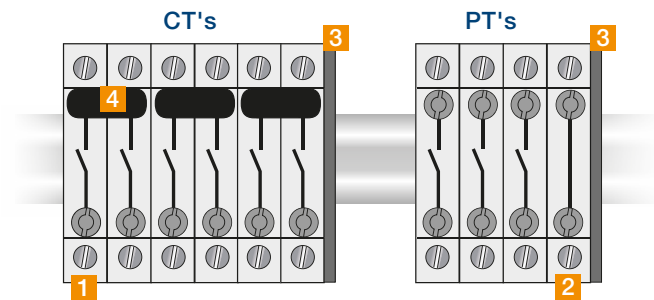

Description	Type	Order code	Qty needed	
			CT's	PT's
1 Terminal block	RGW6-ST-1-V0	1SNA512124R0000	6	3
2 Terminal block	RGW6-R1-V0	1SNA510224R0000	0	1
3 End section	E-RGW6-ST	1SNA519004R0100	1	1
4 Short-circuit plug	SCP12-2	1SNA519300R0200	3	0

RGW6-ST-1 Ring lug terminal blocks

Test disconnect with sliding link - 11 mm 0.433 in spacing

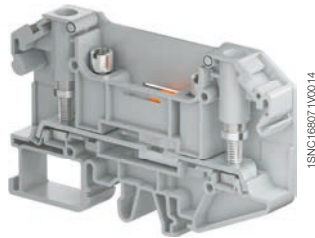
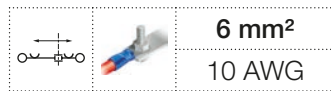

RGW6-ST-1

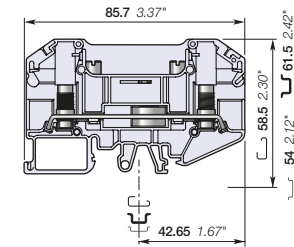

11 mm 0.433 in spacing

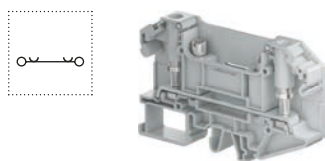
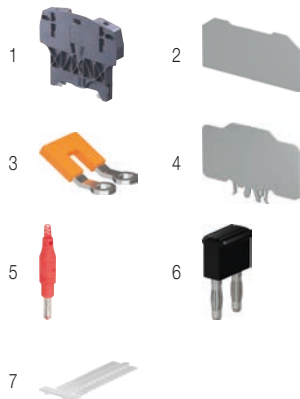

Description

- Stud terminal block for ring lug connection,
- Integrated captive nuts in protective wings provide easy and secured connection,
- Secure your disconnect operations with the disconnect sliding link operated with a standard screwdriver,
- Ease your test operations with the 2 independent built-in test sockets compatible with DIA 4 mm 0.157 in test plugs,
- Universal mounting on symmetrical and asymmetrical rails.

Ordering details

Description	Color	Type	Part Number	Pkg qty	Weight (1 pce) g
Disconnect With 2 studs M4 and captive nuts in wings	Grey <input type="checkbox"/>	RGW6-ST-1-V0	1SNA512124R0000	25	33.66

Main technical data

	IEC	UL	CSA
Lugs	Rigid: Solid/Stranded 0.1 ... 6 mm ² Flexible with insulated ferrule 0.1 ... 6 mm ² Gauge	22 ... 10 AWG	22 ... 10 AWG
Rated current	41 A	30 A	30 A
Maximum current		30 A	
Rated cross section	6 mm ²	10 AWG	10 AWG
Rated voltage	1000 V	600 V	600 V
Rated short-time withstand current (1s)	720 A		
Impulse withstand voltage	8000 V		
Protection	IP10	NEMA 1	

Mounting instructions

Rail		G32, TH 35-7.5, TH 35-15
Nuts		Flat screwdriver Ø 5.5 mm Ø 0.217 in
Tool		
Torque		0.8 ... 1.2 N.m 7.1 ... 10.6 lb.in
Disconnect device		Flat screwdriver Ø 4 mm Ø 0.157 in
Tool		
Torque		0.5 ... 0.8 N.m 4.4 ... 5.3 lb.in
Max width of lug		9.4 mm 0.37 in

The connecting capacity data for one Rigid: Solid/Stranded, or one Flexible conductor (when applicable) is a mandatory information required by IEC, UL and CSA standards (Copper conductors). All other data are provided as supplementary information only. For more details, please consult our CB, UL or CSA certificates and technical datasheet available on <http://www.TE.com>

CE	RoHS	UL US	CSA

Accessories

Description	Color	Type	Part Number	Pkg qty	Weight (1 pce) g	
1 End stops	Dark grey <input checked="" type="checkbox"/>	BAZH1	1SNK900102R0000	20	24.00	
2 End sections	Grey <input type="checkbox"/>	E-RGW6-ST	1SNA519004R0100	25	5.18	
3 Lateral jumper bars	Orange <input checked="" type="checkbox"/>	2 poles	PC-RG6-2	1SNA519104R0200	25	3.44
		3 poles	PC-RG6-3	1SNA519104R0300	20	5.40
		4 poles	PC-RG6-4	1SNA519104R0400	15	7.33
		7 poles	PC-RG6-7	1SNA519104R0700	5	13.24
		10 poles	PC-RG6-10	1SNA519104R1000	5	19.05
4 Circuit separators	Grey <input type="checkbox"/>	CS-RGW-L	1SNA519201R0000	25	13.72	
5 Test plugs	Red <input checked="" type="checkbox"/>	FC4-1	1SNA167927R1000	10	11.00	
6 Short circuit plugs	Black <input checked="" type="checkbox"/>	SCP12-2	1SNA519300R0200	10		
7 Terminal block markers	White <input type="checkbox"/>	M-W810PC	1SNA235510R0800	260	0.27	
		MG-CPM-01 41096	1SNB041096R0810	1120	0.400	

Complete list of accessories is indicated in the terminal block datasheet including end stops. Some accessories such as jumper bars may modify the terminal block's ratings: Complete information available in the accessories section of the catalog.

Feed-through Ring lug terminal blocks

Description	Color	Type	Part Number	Pkg qty	Weight (1 pce) g
Feed-through With 2 studs M4 and captive nuts in wings	Grey <input type="checkbox"/>	RGW6-R1-V0	1SNA510224R0000	25	36.42

Technical data valid for copper conductors only.

RGW6-R1 Ring lug terminal blocks

Feed-through - 11 mm 0.433 in spacing

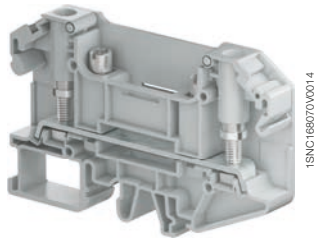

RGW6-R1

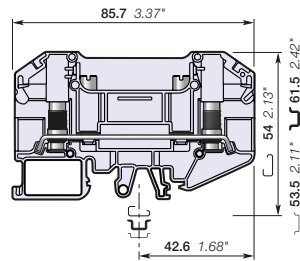

11 mm 0.433 in spacing

Description

- Stud terminal block for ring lug connection,
- Feed-through with the same profile as disconnect terminal block RGW6-ST-1...,
- Integrated captive nuts in protective wings provide easy and secured connection,
- Universal mounting on symmetrical and asymmetrical rails.

Ordering details

Description	Color	Type	Part Number	Pkg qty	Weight (1 pce)
Feed-through With 2 studs M4 and captive nuts in wings	Grey <input type="checkbox"/>	RGW6-R1-V0	1SNA510224R0000	25	36.42

Main technical data

Lugs	Rigid: Solid/Stranded Flexible with insulated ferrule Gauge	IEC	UL	CSA
		0.1 ... 6 mm ²	22 ... 10 AWG	22 ... 10 AWG
Rated current		41 A	30 A	30 A
Maximum current			30 A	
Rated cross section		6 mm ²	10 AWG	10 AWG
Rated short-time withstand current (1s)		720 A		
Rated voltage		1000 V	600 V	600 V
Impulse withstand voltage		8000 V		
Protection		IP10	NEMA 1	

Mounting instructions

Rail		G32, TH 35-7.5, TH 35-15
Nuts		Flat screwdriver Ø 5.5 mm Ø 0.217 in
Tool		
Torque		0.8 ... 1.2 N.m 7.1 ... 10.6 lb.in
Max width of lug		9.4 mm 0.37 in

The connecting capacity data for one Rigid: Solid/Stranded, or one Flexible conductor (when applicable) is a mandatory information required by IEC, UL and CSA standards (Copper conductors). All other data are provided as supplementary information only. For more details, please consult our CB, UL or CSA certificates and technical datasheet available on <http://www.TE.com>

CE	RoHS	UL	CSA

Accessories

Description	Color	Type	Part Number	Pkg qty	Weight (1 pce)
1 End stops 10 mm 0.394 in	Dark grey <input type="checkbox"/>	BAZH1	1SNK900102R0000	20	24.00
2 End sections 1.4 mm 0.055 in	Grey <input type="checkbox"/>	E-RGW6-ST	1SNA519004R0100	25	5.18
3 Lateral jumper bars 2 poles 41 A (IEC) 3 poles 41 A (IEC) 4 poles 41 A (IEC) 7 poles 41 A (IEC) 10 poles 41 A (IEC)	Orange <input type="checkbox"/>	PC-RG6-2	1SNA519104R0200	25	3.44
		PC-RG6-3	1SNA519104R0300	20	5.40
		PC-RG6-4	1SNA519104R0400	15	7.33
		PC-RG6-7	1SNA519104R0700	5	13.24
		PC-RG6-10	1SNA519104R1000	5	19.05
4 Circuit separators 2 mm 0.079 in	Grey <input type="checkbox"/>	CS-RGW-L	1SNA519201R0000	25	13.72
5 Test plugs DIA 4 mm 0.157 in IP20	Red <input type="checkbox"/>	FC4-1	1SNA167927R1000	10	11.00
6 Short circuit plugs	Black <input type="checkbox"/>	SCP12-2	1SNA519300R0200	10	
7 Terminal block markers	White <input type="checkbox"/>	M-W810PC	1SNA235510R0800	260	0.27
		MG-CPM-01 41096	1SNB041096R0810	1120	0.400

Complete list of accessories is indicated in the terminal block datasheet including end stops.

Some accessories such as jumper bars may modify the terminal block's ratings: Complete information available in the accessories section of the catalog.

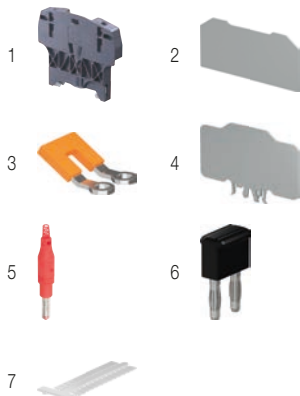

Disconnect Ring lug terminal blocks

Description	Color	Type	Part Number	Pkg qty	Weight (1 pce)
Disconnect With 2 studs M4 and captive nuts in wings	Grey <input type="checkbox"/>	RGW6-ST-1-V0	1SNA512124R0000	25	33.66

Technical data valid for copper conductors only.

End sections

Terminal blocks accessories

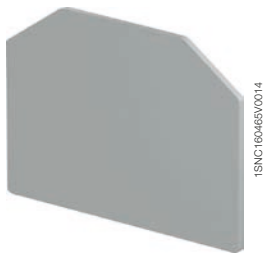

1SNC160466V0014

E-RGW2.5

E-RGW2.5 end sections

Description

– End section compatible with RGW2.5... and RGW2.5-T... terminal block

Ordering details

Description	Color	Type	Part Number	Pkg qty	Weight (1 pce) g
1.2 mm 0.047 in spacing	Grey <input type="checkbox"/>	E-RGW2.5	1SNA519003R0000	25	1.89

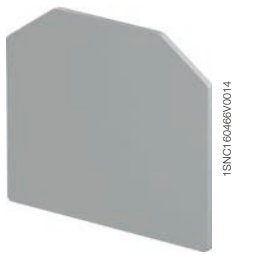

1SNC160466V0014

E-RGW6

E-RGW6 end sections

Description

– End section compatible with RGW6... and RGW6-T... terminal block

Ordering details

Description	Color	Type	Part Number	Pkg qty	Weight (1 pce) g
1.4 mm 0.0551 in spacing	Grey <input type="checkbox"/>	E-RGW6	1SNA519004R0000	50	2.65



1SNC160467V0014

E-RGW6-ST

E-RGW6-ST end sections

Description

– End section compatible with RGW6-ST-1... and RGW6-R1... terminal block

Ordering details

Description	Color	Type	Part Number	Pkg qty	Weight (1 pce) g
1.4 mm 0.0551 in spacing	Grey <input type="checkbox"/>	E-RGW6-ST	1SNA519004R0100	25	5.18

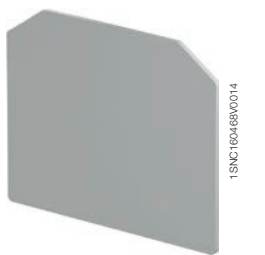

1SNC160469V0014

E-RGW25

E-RGW25 end sections

Description

– End section compatible with RGW25... terminal block

Ordering details

Description	Color	Type	Part Number	Pkg qty	Weight (1 pce) g
1.4 mm 0.0551 in spacing	Grey <input type="checkbox"/>	E-RGW25	1SNA519005R0000	25	0.146

Main technical data

Material specifications	Insulating material	Polyamide			
	Flammability	V0			
	NF F 16 101	I2F2			
Ambient temperature min/max	Service IEC 60068-2-1	-40 ... +100 °C	-40 ... +212 °C		
	Storage	-40 ... +100 °C	-40 ... +212 °C		
	Installing	-25 ... +70 °C	-13 ... +167 °C		

All the main technical data provided are "manufacturer" values.

CE	RoHS								
CE	RoHS								

Technical data valid for copper conductors only.

1SNC160035S0201

Jumper bars

Terminal block accessories



PC-RG2.5

1SNC160468V0014

Lateral jumper bars

Description

- Lateral jumper bar for ring lug terminal block,
- Allow the connection of consecutive blocks,
- Compatible with RGW terminal block.

Ordering details

Description				Color	Type	Part Number	Pkg qty	Weight (1 pce) g	
Compatible with M3 stud. For blocks RGW2.5...									
9 mm	0.354 in	2 poles	24 A (IEC)	Orange	■	PC-RG2.5-2	1SNA519103R0200	25	3.02
		3 poles	24 A (IEC)			PC-RG2.5-3	1SNA519103R0300	20	4.69
		4 poles	24 A (IEC)			PC-RG2.5-4	1SNA519103R0400	15	6.36
		10 poles	24 A (IEC)			PC-RG2.5-10	1SNA519103R1000	5	16.39
Compatible with M4 stud. For blocks RGW6...									
11 mm	0.433 in	2 poles	41 A (IEC)	Orange	■	PC-RG6-2	1SNA519104R0200	25	3.44
		3 poles	41 A (IEC)			PC-RG6-3	1SNA519104R0300	20	5.40
		4 poles	41 A (IEC)			PC-RG6-4	1SNA519104R0400	15	7.33
		7 poles	41 A (IEC)			PC-RG6-7	1SNA519104R0700	5	13.24
		10 poles	41 A (IEC)			PC-RG6-10	1SNA519104R1000	5	19.05
Compatible with M5 or M6 stud. For blocks RGW25...									
18 mm	0.709 in	2 poles	101 A (IEC)	Orange	■	PC-RG25-2	1SNA519106R0200	25	8.81

Main technical data

Material specifications	Insulating material	Polyamide					
	Flammability	V0					
	NF F 16 101	I2F2					
Ambient temperature min/max	Service IEC 60068-2-1	-40 ... +100 °C	-40 ... +212 °C				
	Storage	-40 ... +100 °C	-40 ... +212 °C				
	Installing	-25 ... +70 °C	-13 ... +167 °C				

All the main technical data provided are "manufacturer" values.

CE	RoHS								
CE	RoHS								

Technical data valid for copper conductors only.

Circuit separators

Terminal blocks accessories



1SNC160471V0014

CS-RGW-L

CS-RGW circuit separators

Description

- Circuit separator for RGW terminal blocks,
- Ease the visual identification of the several circuits within the terminal block assemblies,
- Compatible with all RGW terminal blocks.

Ordering details

Description	Color	Type	Part Number	Pkg qty	Weight (1 pce) g
2 mm 0.078 in spacing	Grey <input type="checkbox"/>	CS-RGW-L	1SNA519201R0000	25	13.72



1SNC160470V0014

CS-RGW-S

CS-RGW circuit separators

Description

- Circuit separator for RGW terminal blocks,
- Ease the visual identification of the several circuits within the terminal block assemblies,
- Compatible with RGW feed-through and ground terminal blocks up to 11 mm 0.433 in spacing.

Ordering details

Description	Color	Type	Part Number	Pkg qty	Weight (1 pce) g
1.5 mm 0.059 in spacing	Grey <input type="checkbox"/>	CS-RGW-S	1SNA519200R0000	25	4.59

Main technical data

Material specifications	Insulating material	Polyamide			
	Flammability	V0			
	NF F 16 101	I2F2			
Ambient temperature min/max	Service IEC 60068-2-1	-40 ... +100 °C	-40 ... +212 °C		
	Storage	-40 ... +100 °C	-40 ... +212 °C		
	Installing	-25 ... +70 °C	-13 ... +167 °C		

All the main technical data provided are "manufacturer" values.

CE	RoHS																		
CE	RoHS																		

Technical data valid for copper conductors only.

1SNC160037S0201

RGW Ring lug terminal blocks





RGW Accessories

Markers and marking systems

Marking systems

Support plates

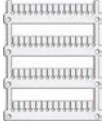
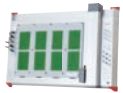
Markers

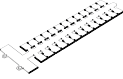
Marking systems		Support plates		Markers	
Type	Part Number	Type	Part Number	Type	Part Number
 MG3 KIT	1SNB419001R0000	 MG2-QTB 991011	1SNB991011R0000	 MG-CPM-01 41090 MG-CPM-01-41096	1SNB041090R0510 1SNB041096R0810
 AMS 600 KIT AMS 250 BASIC KIT	1SNA360000R2400 1SNA360000R2500	 SPRC 26	1SNA360036R0300	 M-W610PC M-W810PC M-W1010PC	1SNA235511R0600 1SNA235510R0800 1SNA235512R1000

1SNC166039S0201

LET'S CONNECT

We make it easy to connect with our experts and are ready to provide all the support you need. For additional information or product assistance, please contact your field representative or our customer service department. Additional information is also available on the website <http://www.te.com/entrelec>.

TECHNICAL SUPPORT

te.com/support-center

Asia:

+86 400-820-6015

Europe, Middle East, & Africa:

+49 6251-133-0

North America:

+1-888-441-9982

te.com

ENTRELEC, TE Connectivity, TE Connectivity (logo) and Every Connection Counts are trademarks. All other logos, products and/or company names referred to herein might be trademarks of their respective owners.

All other logos, products and/or company names referred to herein might be trademarks of their respective owners.

The information given herein, including drawings, illustrations and schematics which are intended for illustration purposes only, is believed to be reliable. However, TE Connectivity makes no warranties as to its accuracy or completeness and disclaims any liability in connection with its use. TE Connectivity's obligations shall only be as set forth in TE Connectivity's Standard Terms and Conditions of Sale for this product and in no case will TE Connectivity be liable for any incidental, indirect or consequential damages arising out of the sale, resale, use or misuse of the product. Users of TE Connectivity products should make their own evaluation to determine the suitability of each such product for the specific application.

© 2020 TE Connectivity Ltd. family of companies All Rights Reserved.

1-1773970-7_EN

01/20 - Printed in France (PDF)

TE Connectivity

3, rue Jean Perrin
69687 Chassieu cedex
France

Tel: +33 481923100

www.te.com/

X-ON Electronics

Largest Supplier of Electrical and Electronic Components

Click to view similar products for [DIN Rail Terminal Blocks](#) category:

Click to view products by [TE Connectivity](#) manufacturer:

Other Similar products are found below :

[00110420202](#) [00175550302](#) [CTS25U/BL](#) [9123140000](#) [RBO 5-T-B-HEX](#) [90.070](#) [90.202](#) [912314](#) [260-301_NR](#) [280-560](#) [280-564](#) [281-611/281-542](#) [281-673/281-411](#) [281-994](#) [283-317](#) [283-607](#) [264-724](#) [264-726](#) [280-530](#) [280-555](#) [280-619](#) [281-610](#) [281-622/281-417](#) [284-317](#) [35956](#) [USK 10](#) [102510](#) [1126840000](#) [5520682](#) [EMH 25-ZE30](#) [UM 45-SEFE M.NUT BK](#) [1-591651-1](#) [8671050000](#) [264-706](#) [281-664](#) [592814-1](#) [592814-3](#) [UMSTBVK 2 5/ 5-STF-5 08](#) [NRA37-12](#) [2002-1203](#) [2002-1205](#) [270-480](#) [CMT4/Y](#) [CMT4/G](#) [90.001](#) [CTS95/120N](#) [CSTSN6U](#) [0363660000](#) [DK 4QV/35](#) [EB 2- 8 0202154](#) [PT 2,5-TG 3210185](#)