



MS5840-02BA

Low profile, gel-filled, ultra-compact, water resistant digital pressure and temperature sensor

There is an increasing demand for sensor components that offer high performance and precision in small spaces. To meet this need TE Connectivity (TE) has designed the MS5840-02BA sensor module with one of the lowest profile footprints in the market (3.3 x 3.3 x 1.7 mm). This ultra-compact, gel-filled pressure and temperature sensor is optimized for applications with small space constraints.

TE is a global leader in developing sensor solutions for harsh and complex environments. Our MS5840-2BA is optimized for consumer devices such as fitness trackers, drones and wearables providing a robust sensor package to withstand the harsh environments often encountered in these applications.

This MEMS based sensor includes a high-linearity pressure sensor with low power (0.6 μ A), 24-bit digital output (I²C) and an altitude resolution at sea level of 13 cm. This enables high resolution measurements such as counting flights of stairs. The board level design delivers sensing accuracy for both pressure (\pm 0.5mbar) and temperature (\pm 2^oC) measurements.

Our MS5840-02BA provides exceptional performance, reliability and accurate performance from a brand you can trust.

APPLICATIONS

- Fitness Trackers
- Swim Watches
- Shallow Diving Computers
- Drones / Underwater Drones
- Diving Equipment
- E-cigarettes
- Mobile Altimeter/Barometer Systems
- Wearables

FEATURES

- Ceramic and metal package: 3.3 x 3.3 x 1.7mm
- High-resolution module: 13cm
- Supply voltage: 1.5 to 3.6V
- Fast conversion down to 0.5ms
- Low power, 0.6 μ A (standby \leq 0.1 μ A at 25^oC)
- Integrated digital pressure sensor (24-bit $\Delta\Sigma$ ADC)
- Operating range: 300 to 1200mbar, -20 to +85^oC
- I²C interface
- No external components (internal oscillator)
- Shielded metal lid
- Chlorine resistant option

PERFORMANCE SPECIFICATIONS

ABSOLUTE MAXIMUM RATINGS

Parameter	Symbol	Conditions	Min.	Typ.	Max	Unit
Supply voltage	V _{DD}		-0.3		+4	V
Storage temperature	T _S		-40		+85	°C
Overpressure	P _{max}	ISO 22810 ⁽¹⁾			10	bar
Maximum Soldering Temperature ⁽²⁾	T _{max}	40 sec. max			250	°C
ESD rating (lid to GND version)		Human Body Model	-2		+2	kV
Latch up		JEDEC JESD78 standard	-100		+100	mA

⁽¹⁾ Pressure ramp up/down min 60s

⁽²⁾ Refer to application note 808

ELECTRICAL CHARACTERISTICS

Parameter	Symbol	Conditions	Min.	Typ.	Max	Unit
Operating Supply voltage	V _{DD}		1.5	3.0	3.6	V
Operating Temperature	T		-20	+25	+85	°C
Supply current (1 sample per sec.)	I _{DD}	OSR		20.09 10.05 5.02 2.51 1.26 0.63		µA
Peak supply current		during conversion		1.25		mA
Standby supply current		at 25°C (V _{DD} = 3.0 V)		0.01	0.1	µA
Power supply hold off for internal reset ⁽³⁾		V _{DD} < 0.1V	200			ms
VDD Capacitor		from VDD to GND	100	470		nF
Resistor value between the lid and the GND		Version 02BA2x, 02BA3x		1000		Ω

⁽³⁾ Supply voltage power up must be continuous from GND to VDD without any step

ANALOG DIGITAL CONVERTER (ADC)

Parameter	Symbol	Conditions	Min.	Typ.	Max	Unit
Output Word				24		bit
ADC Conversion time ⁽⁴⁾	t _c	OSR		16.44 8.22 4.13 2.08 1.06 0.54	17.2 8.61 4.32 2.17 1.10 0.56	ms

⁽⁴⁾ Maximum values must be used to determine waiting times in I2C communication

PERFORMANCE SPECIFICATIONS (CONTINUED)

PRESSURE OUTPUT CHARACTERISTICS ($V_{DD} = 3\text{ V}$, $T = 25^\circ\text{C}$ UNLESS OTHERWISE NOTED)

Parameter	Conditions		Min.	Typ.	Max	Unit
Operating Pressure Range	P_{range}		300		1200	mbar
Extended Pressure Range	P_{ext}	Linear Range of ADC	10		2000	mbar
Relative Accuracy ^{(1) (4)}	600...1000 mbar, at 20°C		-0.5		+0.5	mbar
	300...1100 mbar, 0...60°C		-2		+2	
	300...1100 mbar, -20...85°C		-4		+4	
Resolution RMS	OSR	8192		0.016	mbar	
		4096		0.021		
		2048		0.028		
		1024		0.039		
		512		0.062		
		256		0.11		
Maximum error with supply voltage ⁽²⁾	$V_{DD} = 1.5\text{ V} \dots 3.6\text{ V}$			± 2		mbar
Long-term stability				± 2		mbar/yr
Reflow soldering impact	IPC/JEDEC J-STD-020C (Refer to application note AN808)			± 4		mbar
Recovering time after reflow ⁽³⁾				7		days

⁽¹⁾ With autozero at one pressure point

⁽²⁾ With autozero at 3V point

⁽³⁾ Time to recover at least 66% of reflow impact

⁽⁴⁾ Wet/dry cycle: sensor must be dried typically once a day

TEMPERATURE OUTPUT CHARACTERISTICS ($V_{DD} = 3\text{ V}$, $T = 25^\circ\text{C}$ UNLESS OTHERWISE NOTED)

Parameter	Conditions		Min.	Typ.	Max	Unit
Relative Accuracy	0...60°C, 600...1100 mbar			± 1		°C
	-20...85°C, 300...1100 mbar		-2		+2	°C
Maximum error with supply voltage	$V_{DD} = 1.5\text{ V} \dots 3.6\text{ V}$			± 0.3		°C
Resolution RMS	OSR	8192		0.002	°C	
		4096		0.003		
		2048		0.004		
		1024		0.006		
		512		0.009		
		256		0.012		

MS5840-02BA

Low profile, gel-filled, ultra-compact, water resistant digital pressure and temperature sensor

DIGITAL INPUTS (SDA, SCL)

Parameter	Symbol	Conditions	Min.	Typ.	Max	Unit
Serial data clock	SCL				400	kHz
Input high voltage	V _{IH}		80% V _{DD}		100% V _{DD}	V
Input low voltage	V _{IL}		0% V _{DD}		20% V _{DD}	V
Input leakage current	I _{leak}	T = 25 °C			0.1	μA

DIGITAL OUTPUTS (SDA)

Parameter	Symbol	Conditions	Min.	Typ.	Max	Unit
Output high voltage	V _{OH}	I _{source} = 1 mA	80% V _{DD}		100% V _{DD}	V
Output low voltage	V _{OL}	I _{sink} = 1 mA	0% V _{DD}		20% V _{DD}	V

TYPICAL PERFORMANCE CHARACTERISTICS

**RELATIVE PRESSURE ERROR AND TEMPERATURE ERROR VS PRESSURE AND TEMPERATURE
(TYPICAL VALUES)**

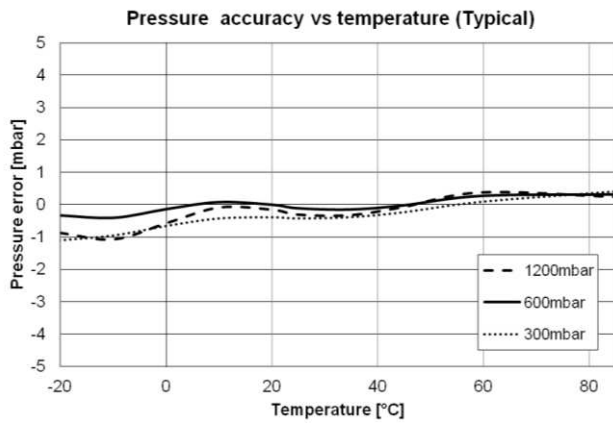
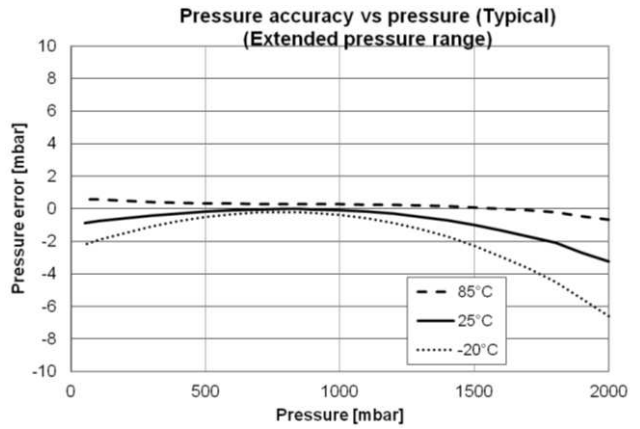
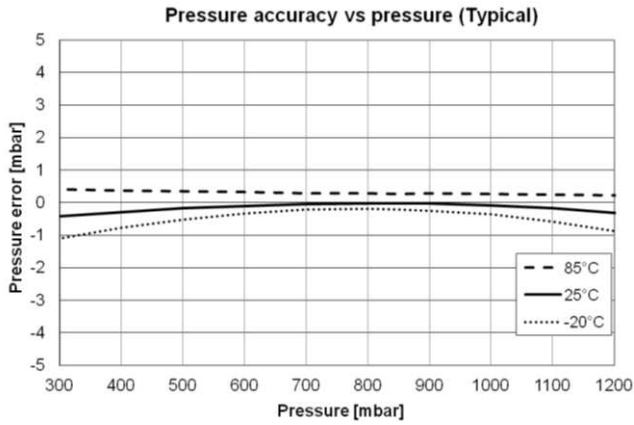

TYPICAL PERFORMANCE CHARACTERISTICS

RELATIVE PRESSURE AND TEMPERATURE ERROR VS TEMPERATURE

(1ST ORDER AND 2ND ORDER ALGORITHM, TYPICAL VALUES)

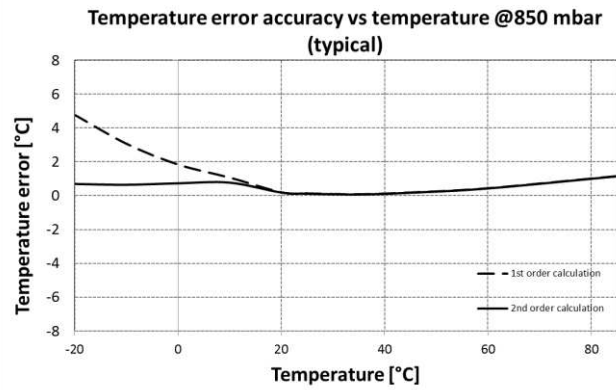
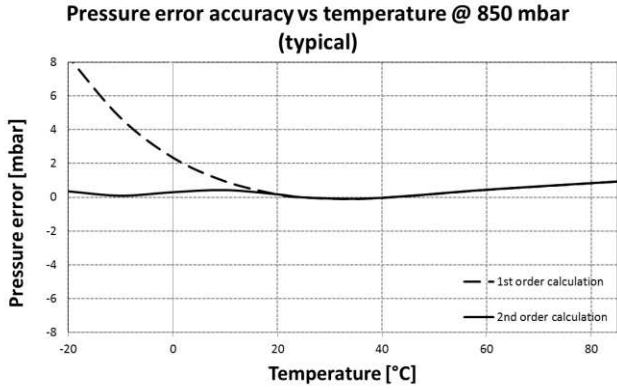

RELATIVE PRESSURE AND TEMPERATURE ERROR VS POWER SUPPLY

(TYPICAL VALUES)

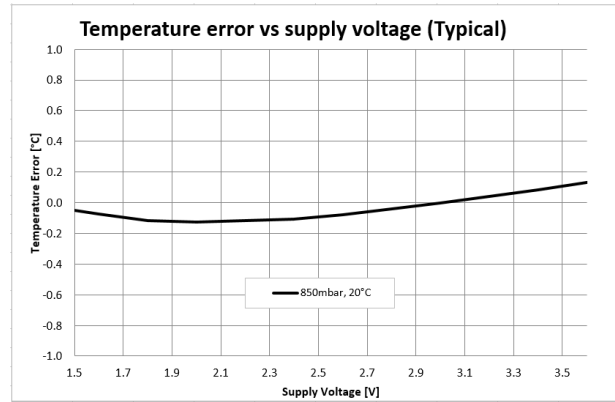
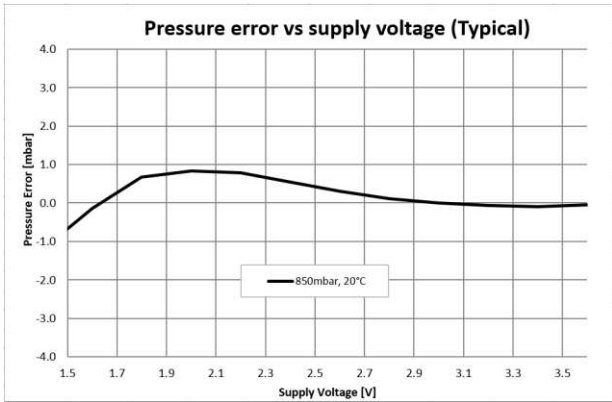

MS5840-02BA

Low profile, gel-filled, ultra-compact, water resistant digital pressure and temperature sensor

PRESSURE AND TEMPERATURE CALCULATION

GENERAL

The MS5840 consists of a piezo-resistive sensor and a sensor interface integrated circuit. The main function of the MS5840 is to convert the uncompensated analog output voltage from the piezo-resistive pressure sensor to a 24-bit digital value, as well as providing a 24-bit digital value for the temperature of the sensor.

FACTORY CALIBRATION

Every module is individually factory calibrated at two temperatures and two pressures. As a result, 8 coefficients necessary to compensate for process and temperature variations are calculated and stored in the 112 bits PROM of each module. These bits (stored in 16 bits word from W0 to W6) must be read and used together with the D1 and D2 values to get the compensated pressure and temperature values.

The coefficient W0 contains also factory configuration bits and a CRC, as represented in " Figure 10 : Version number in Word 0" below.

SERIAL I²C INTERFACE

The external microcontroller clocks in the data through the input SCL (Serial CLock) and SDA (Serial DAta). The sensor responds on the same pin SDA which is bidirectional for the I²C bus interface. This interface type uses only 2 signal lines and does not require a chip select.

Module ref	Mode	Pins used	Address (7 bits)
MS5840-02BA	I ² C	SDA, SCL	0x76 (1110110 b)

FIRST ORDER PRESSURE AND TEMPERATURE CALCULATION

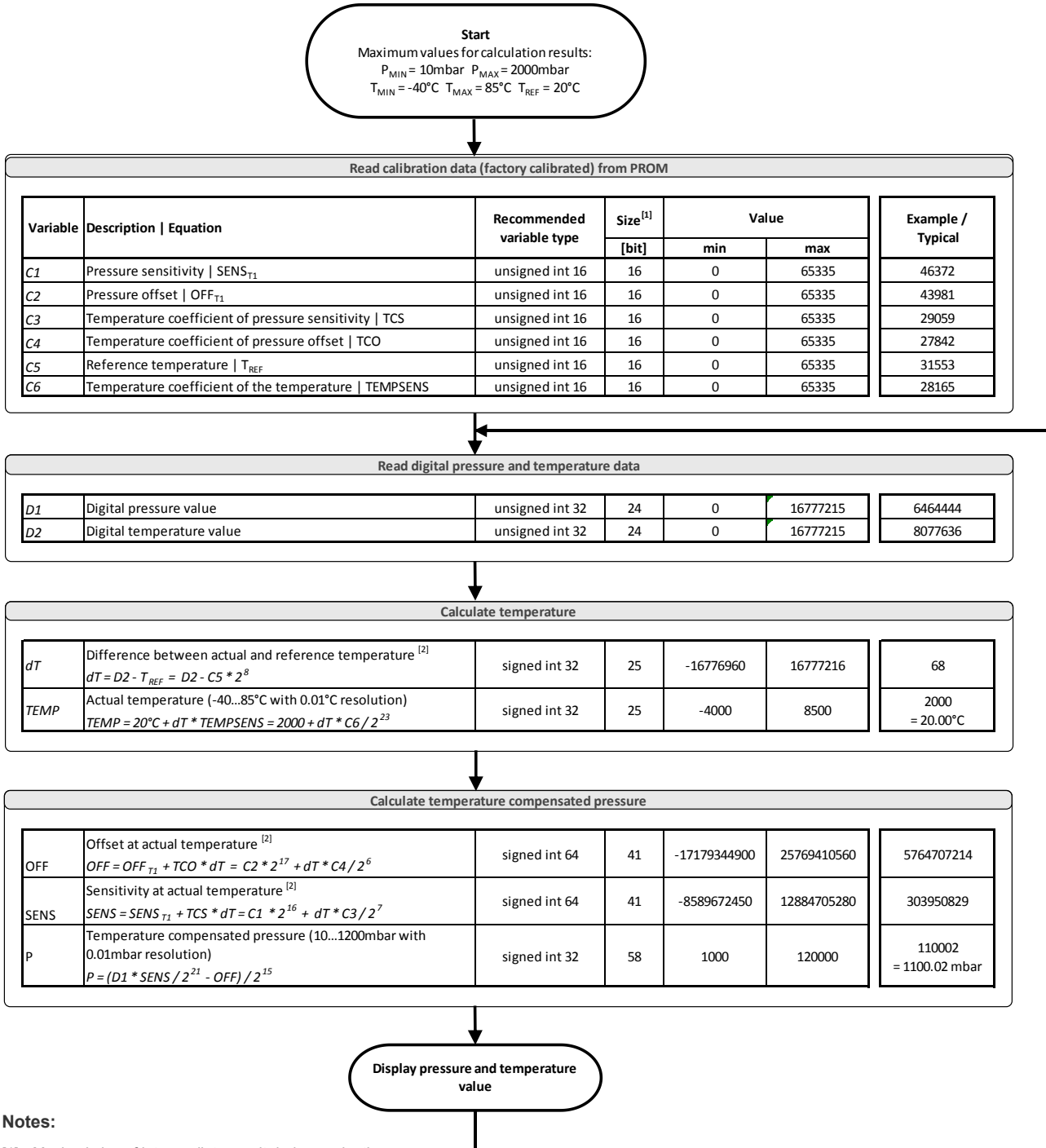

Notes:

- [1] Maximal size of intermediate result during evaluation of variable
- [2] Min and max have to be defined

Figure 1 : Pressure and temperature first order

SECOND ORDER TEMPERATURE COMPENSATION

The results of the first order calculation are used as described in the following chart to obtain the 2nd order pressure and temperature compensated values.

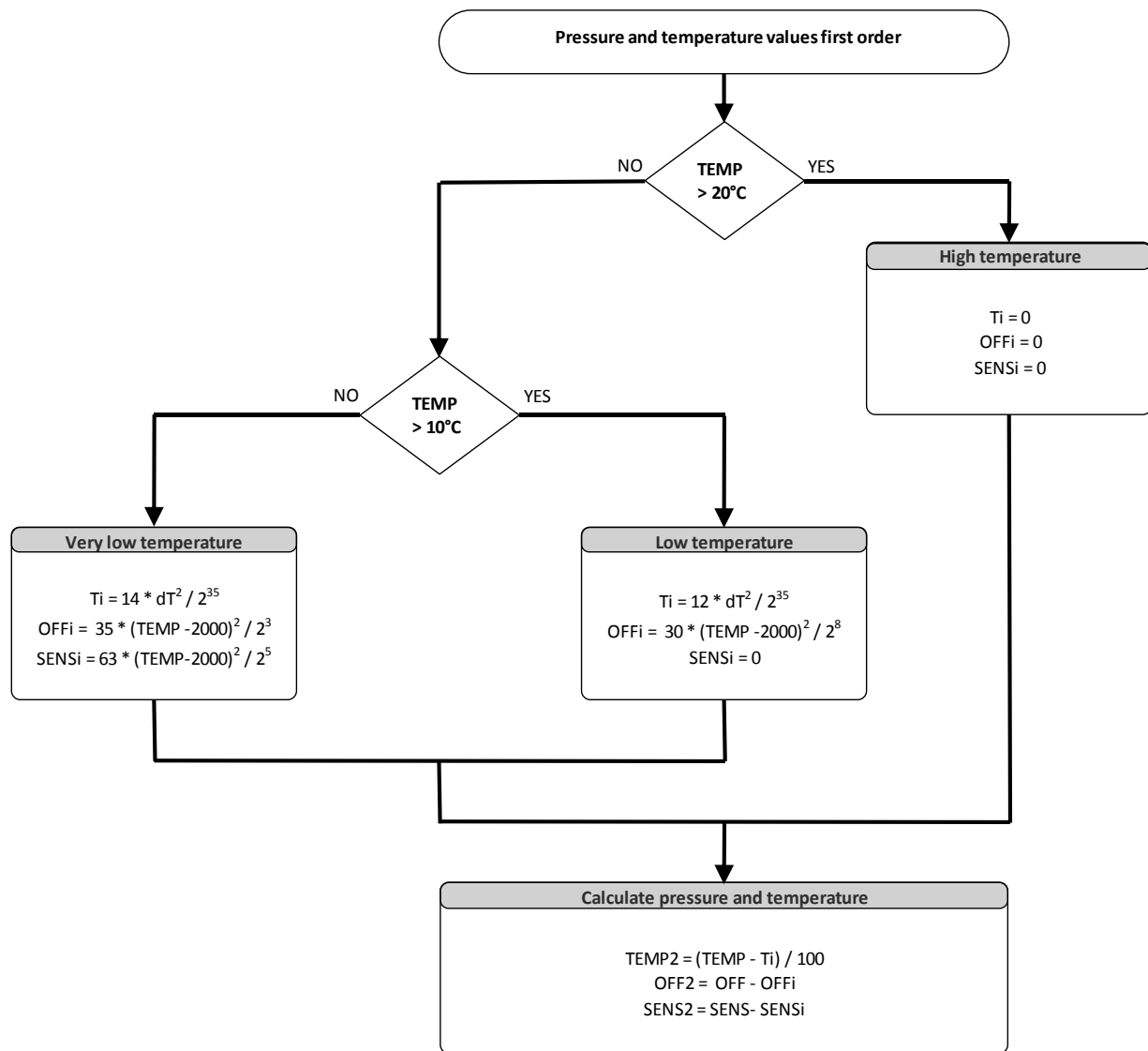

Figure 2 : Second order compensation flowchart

I²C INTERFACE**COMMANDS**

The MS5840 has only five basic commands:

1. Reset
2. Read PROM (112 bit of calibration words)
3. D1 conversion
4. D2 conversion
5. Read ADC result (24-bit pressure / temperature)

Size of each command is 1 byte (8 bits) as described in the table "Figure 3 : Command structure" below. After the PROM read command, sensor responds with 16 bits word. Bits A2, A1 and A0 select PROM addresses. Conversion is started after a "Convert D1" or "Convert D2" with the requested OSR is issued. Conversion time depends on the OSR as shown in the table specifications. Maximum waiting time values need to be used to ensure finished operation.

ADC read command will return 24 bits result of the above requested finished conversion.

Bit number	Command byte								hex value
	0	1	2	3	4	5	6	7	
Bit name	PR M	COV	-	Typ	A2/ Os2	A1/ Os1	A0/ Os0	Stop	
Command									
Reset	0	0	0	1	1	1	1	0	0x1E
Convert D1 (OSR=256)	0	1	0	0	0	0	0	0	0x40
Convert D1 (OSR=512)	0	1	0	0	0	0	1	0	0x42
Convert D1 (OSR=1024)	0	1	0	0	0	1	0	0	0x44
Convert D1 (OSR=2048)	0	1	0	0	0	1	1	0	0x46
Convert D1 (OSR=4096)	0	1	0	0	1	0	0	0	0x48
Convert D2 (OSR=256)	0	1	0	1	0	0	0	0	0x50
Convert D2 (OSR=512)	0	1	0	1	0	0	1	0	0x52
Convert D2 (OSR=1024)	0	1	0	1	0	1	0	0	0x54
Convert D2 (OSR=2048)	0	1	0	1	0	1	1	0	0x56
Convert D2 (OSR=4096)	0	1	0	1	1	0	0	0	0x58
ADC Read	0	0	0	0	0	0	0	0	0x00
PROM Read	1	0	1	0	A2	A1	A0	0	0xA0 to 0xAC

Figure 3 : Command structure

RESET SEQUENCE

At power on, an internal reset circuitry ensures calibration PROM data gets loaded into the internal register. Reset sequence can be sent once to make sure this operation is successfully done. It can be also used to reset the device PROM from an unknown condition.

The reset can be sent at any time. In the event that there is no successful power on reset, maybe caused by the SDA being blocked by the module in the acknowledge state, the only way to get the MS5840 back to function, is to send several SCLs until SDA release, followed by a reset sequence, or to perform a power OFF-ON cycle.

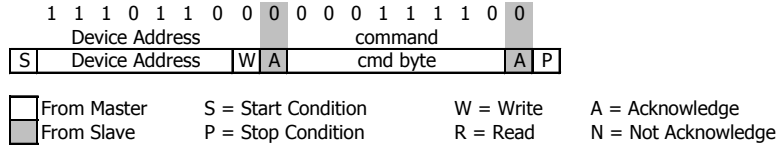

Figure 4 : I²C Reset Command

PROM READ SEQUENCE

The read command for PROM must be executed once after reset by the user software to read the content of the calibration PROM and extract / store the calibration coefficients. There are 7 addresses resulting in a total memory content of 112 bits. Memory words contain: factory data, calibration coefficients and CRC. Command sequence is 8 bits wide and slave responses will send back 16 bits result which is clocked with the MSB first.

The PROM read command is divided in two parts. Firstly, ASIC is set into PROM read mode and address of the requested word is issued. Then, content of addressed memory word is read.

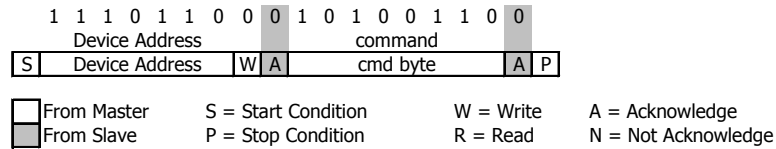

Figure 5 : I²C Command to read memory address= 011

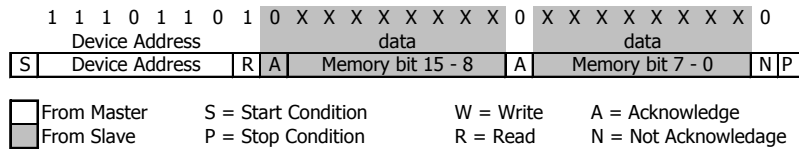

Figure 6 : I²C answer from MS5840

CONVERSION SEQUENCE

The conversion command is used to initiate uncompensated pressure (D1) or uncompensated temperature (D2) conversion. Once finished, raw values are read using “ADC read command”. Result is clocked out with MSB first. If conversion is not finished before sending the “ADC read command”, or the “ADC read command” is repeated, conversion will not stop but issued result will be wrong. Conversion sequence command sent during the already started conversion process will yield incorrect result as well.

Once command issued, the ADC will start converting the values from the sensing element into digital 24-bit format. Conversion time is dependent from selected OSR (page 2). After the conversion is performed, the data can be accessed by sending a read command as shown below.

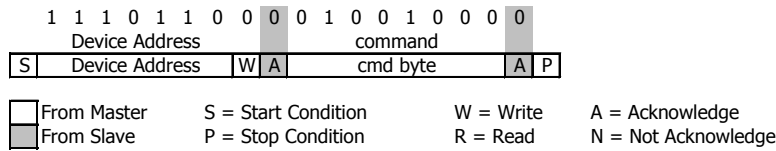

Figure 7 : I²C command to initiate a pressure conversion (OSR=4096, typ=D1)

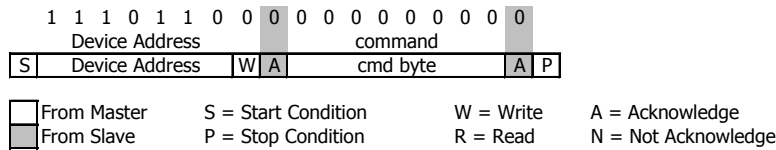

Figure 8 : I²C ADC read sequence

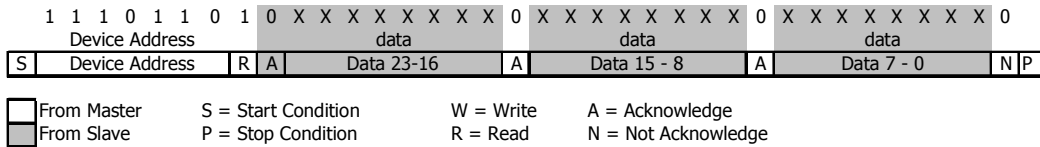

Figure 9 : I²C answer from MS5840

VERSION IDENTIFICATION NUMBER (WORD 0)

Depending on product version, bits [11:5] of memory address 0 are programmed with the following fixed values:

MS5840-02BA21

Address	15	14	13	12	11	10	9	8	7	6	5	4	3	2	1	0
0	crc				0	0	0	0	0	0	0	factory configuration bits				

MS5840-02BA36

Address	15	14	13	12	11	10	9	8	7	6	5	4	3	2	1	0
0	crc				0	1	0	0	1	0	0	factory configuration bits				

Figure 10 : Version number in Word 0

CYCLIC REDUNDANCY CHECK (CRC)

A 4-bits CRC has been implemented to check the data validity in memory. The CRC read in the first four bits of W0 must be equal to the CRC calculated (see algorithm below) with all other PROM bits to ensure memory content integrity.

	D B 1 5	D B 1 4	D B 1 3	D B 1 2	D B 1 1	D B 1 0	D B 9	D B 8	D B 7	D B 6	D B 5	D B 4	D B 3	D B 2	D B 1	D B 0
0	CRC				Version number				Factory configuration bits							
1	C1															
2	C2															
3	C3															
4	C4															
5	C5															
6	C6															

Figure 11 : Memory PROM mapping

C CODE EXAMPLE FOR CRC-4 CALCULATION:

```

unsigned char crc4(unsigned int n_prom[]) // n_prom defined as 8x unsigned int (n_prom[8])
{
    int cnt; // simple counter
    unsigned int n_rem=0; // crc remainder
    unsigned char n_bit;
    n_prom[0]=((n_prom[0]) & 0x0FFF); // CRC byte is replaced by 0
    n_prom[7]=0; // Subsidiary value, set to 0
    for (cnt = 0; cnt < 16; cnt++) // operation is performed on bytes
    { // choose LSB or MSB
        if (cnt%2==1) n_rem ^= (unsigned short) ((n_prom[cnt]>>1]) & 0x00FF);
        else n_rem ^= (unsigned short) (n_prom[cnt]>>1]>>8);
        for (n_bit = 8; n_bit > 0; n_bit--)
        {
            if (n_rem & (0x8000)) n_rem = (n_rem << 1) ^ 0x3000;
            else n_rem = (n_rem << 1);
        }
    }
    n_rem= ((n_rem >> 12) & 0x000F); // final 4-bit remainder is CRC code
    return (n_rem ^ 0x00);
}
    
```

MS5840-02BA

Low profile, gel-filled, ultra-compact, water resistant digital pressure and temperature sensor

APPLICATION CIRCUIT

MS5840 is a sensor that can be used in conjunction with a microcontroller in mobile altimeter applications. A typical application circuit is presented in "Figure 12 : Typical application circuit"

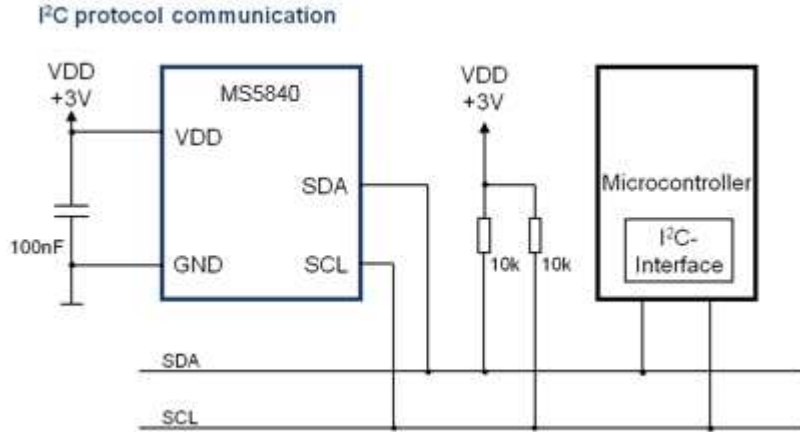
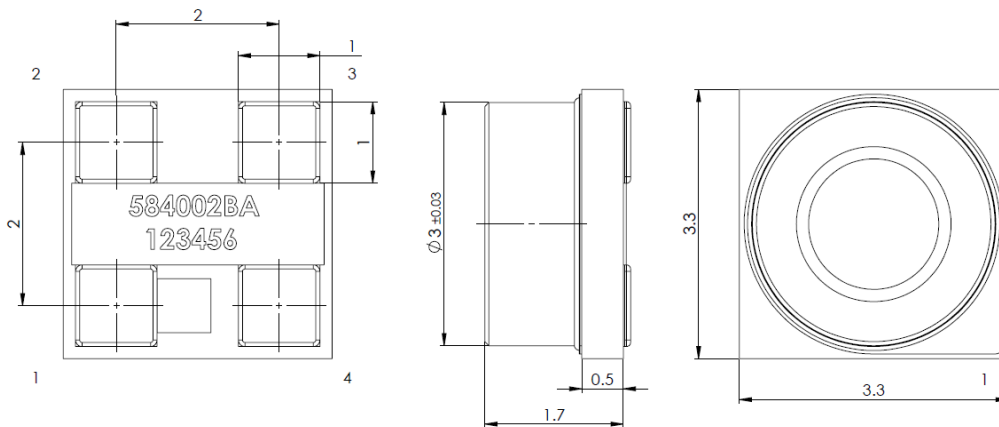

Figure 12 : Typical application circuit

PIN CONFIGURATION AND DEVICE PACKAGE OUTLINE.



UNLESS OTHERWISE SPECIFIED DIMENSIONS ARE IN MILLIMETERS. GENERAL TOLERANCE $\pm 0.15\text{mm}$

1	GND	GROUND
2	VDD	POSITIVE SUPPLY
3	SCL	I ² C CLOCK
4	SDA	I ² C DATA

Figure 13 : Package outlines and pin configuration

MS5840-02BA

Low profile, gel-filled, ultra-compact, water resistant digital pressure and temperature sensor

RECOMMENDED PAD LAYOUT

Pad layout for bottom side of the MS5840 soldered onto printed circuit board.

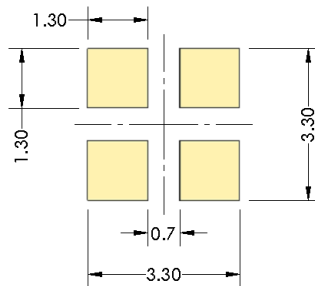

Figure 14 : PCB footprint

SHIPPING PACKAGE

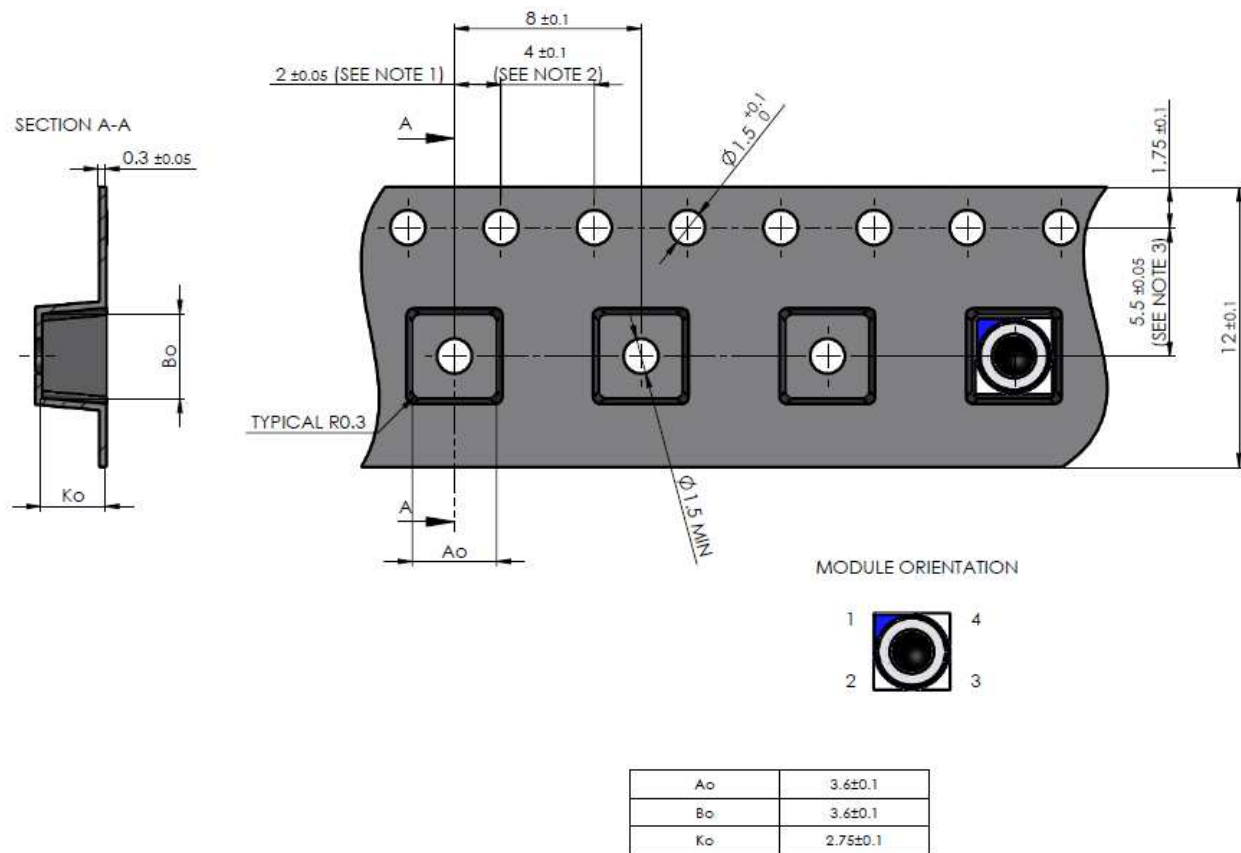

Figure 15 : Tape dimensions

MS5840-02BA

Low profile, gel-filled, ultra-compact, water resistant digital pressure and temperature sensor

MOUNTING AND ASSEMBLY CONSIDERATIONS

SOLDERING

Please refer to the application note AN808 available on our website for soldering recommendations.

MOUNTING

The MS5840 can be processed with automatic Pick & Place equipment using vacuum nozzles. It will not be damaged by the vacuum.

Due to the low stress assembly, the sensor does not show pressure hysteresis effects. It is important to solder all contact pads. Gel must stay free of external physical contact when manipulation.

CONNECTION TO PCB

The package outline of the module allows the use of a flexible PCB. This is ideal for small-sized applications.

SEALING

In applications such as outdoor watches the electronics must be protected against direct water or humidity. For such applications the MS5840 provides the possibility to seal with a gasket or an O-ring.

CLEANING

The MS5840 has been manufactured under clean-room conditions. It is therefore recommended to assemble the sensor under class 10'000 or better conditions. Should this not be possible, it is recommended to protect the sensor opening during assembly from entering particles and dust. To avoid cleaning of the PCB, solder paste of type "no-clean" shall be used. Warning: cleaning might damage the sensor.

ESD PRECAUTIONS

The electrical contact pads are protected against ESD up to 2 kV HBM (human body model). It is therefore essential to ground machines and personal properly during assembly and handling of the device. The MS5840 is shipped in antistatic transport boxes. Any test adapters or production transport boxes used during the assembly of the sensor shall be of an equivalent antistatic material.

DECOUPLING CAPACITOR

Particular care must be taken when connecting the device to the power supply. A minimum of 100nF ceramic capacitor must be placed as close as possible to the MS5840 VDD pin. This capacitor will stabilize the power supply during data conversion and thus, provide the highest possible accuracy.

MS5840-02BA

Low profile, gel-filled, ultra-compact, water resistant digital pressure and temperature sensor

ORDERING INFORMATION

PART NUMBER	DESCRIPTION	SHIELDING	CHLORINE RESISTANT
20000980-00	MS5840-02BA21 LP PRESS SENSOR T&R	X	
20000982-00	MS5840-02BA36 LP PRESS SENSOR T&R	X	X

NORTH AMERICA

Tel +1 800 522 6752
customercare.frm@te.com

EUROPE

Tel +31 73 624 6999
customercare.bevx@te.com

ASIA

Tel +86 0400 820 6015
customercare.shzn@te.com

te.com/sensorsolutions

Measurement Specialties (MEAS), TE Connectivity, TE Connectivity (logo) and EVERY CONNECTION COUNTS are trademarks. All other logos, products and/or company names referred to herein might be trademarks of their respective owners.

The information given herein, including drawings, illustrations and schematics which are intended for illustration purposes only, is believed to be reliable. However, TE Connectivity makes no warranties as to its accuracy or completeness and disclaims any liability in connection with its use. TE Connectivity's obligations shall only be as set forth in TE Connectivity's Standard Terms and Conditions of Sale for this product and in no case will TE Connectivity be liable for any incidental, indirect or consequential damages arising out of the sale, resale, use or misuse of the product. Users of TE Connectivity products should make their own evaluation to determine the suitability of each such product for the specific application.

© 2019 TE Connectivity Ltd. family of companies All Rights Reserved.

X-ON Electronics

Largest Supplier of Electrical and Electronic Components

Click to view similar products for [Board Mount Pressure Sensors](#) category:

Click to view products by [TE Connectivity](#) manufacturer:

Other Similar products are found below :

[6407-249V-17343P](#) [6407-250V-09273P](#) [6407-250V-09343P](#) [80527-25.0H2-05](#) [80541-B00000150-01](#) [80541-B00000200-05](#) [80554-00700100-05](#) [80568-00300050-01](#) [93.631.4253.0](#) [93.731.4353.0](#) [93.932.4553.0](#) [136PC15A1](#) [142PC95AW71](#) [142PC05DW70](#) [15PSI-G-4V1805-01A-L0N-B](#) [26PCBKT](#) [26PCCFA6D26](#) [26PCCFS2G](#) [26PCCVA6D](#) [93.632.7353.0](#) [93.731.3653.0](#) [93.931.4853.0](#) [93.932.4853.0](#) [SDP510-500PA](#) [185PC30DH](#) [26PCAFJ3G](#) [26PCCEP5G24](#) [26PCCFJ3G](#) [26PCDFA3G](#) [26PCJEU5G19](#) [30INCH-D1-MV-MINI](#) [ASCX15AN-90](#) [ASCX15AN/SZ76114](#) [4426-015G](#) [4525-DS5A030DP](#) [DCAL401DN](#) [DCAL401GN](#) [4515-DS5A020DP](#) [XZ202798SSC](#) [XZ203676HSC](#) [6407-249V-09273P](#) [6407-249V-09343P](#) [6407-249V-17273P](#) [6407-250V-17273P](#) [6407-250V-17343P](#) [81717-00000050-05](#) [81794-B00001200-01](#) [82681-B00000100-01](#) [TSCDLNN100MDUCV](#)