

Features

- Amplified $\pm 1.25V$ Signal Output
- 3.0 to 5.5Vdc Excitation Voltage
- Hermetically Sealed LCC Package
- Piezo-Ceramic Crystal, Shear Mode
- -40° to $+125^{\circ}C$ Operating Range
- Small PCB footprint

Applications

- Machine Health Monitoring
- Predictive Maintenance Installations
- Embedded Vibration Monitoring
- Impact & Shock Monitoring
- Data Loggers
- Bearing Installations
- Security monitoring

820M1 SINGLE AXIS CONDITION MONITORING ACCELEROMETER

SPECIFICATIONS

- **Single Axis Piezoelectric Accelerometer**
- **$\pm 25g$ to $\pm 6000g$ Dynamic Ranges**
- **Wide Bandwidth to 10,000Hz**
- **Superior Resolution to MEMS Devices**
- **Circuit Board Mountable, Reflow Solderable**
- **Low Cost, Superior Value**

The Model 820M1 is a low cost, single axis board mountable accelerometer designed for embedded condition monitoring and preventive maintenance applications. The piezo-electric accelerometer is available in ranges from $\pm 25g$ to $\pm 6000g$ and features a flat frequency response up to $>10kHz$. The model 820M1 accelerometer features a stable piezo-ceramic crystal in shear mode with low power electronics, sealed in a fully hermetic LCC package.

The PE technology incorporated in the 820M1 accelerometer has a proven track record for offering the reliable and long-term stable output required for condition monitoring applications. The accelerometer is designed and qualified for machine health monitoring and has superior resolution, dynamic range and bandwidth compared to MEMS devices.

For three axis measurements, TE Connectivity also offers other accelerometer models with the same outstanding performance specifications.

CLICK HERE ›
CONNECT WITH A SPECIALIST

820M1 SINGLE AXIS ACCELEROMETER

ABSOLUTE MAXIMUM RATINGS⁽¹⁾

Parameter	Symbol	Min	Typ	Max	Unit	Notes/Conditions
Supply voltage ⁽²⁾	V _{dd}	1.5	3.3	5.5	V	
Storage temperature	T _s	-40		125	°C	
Shock limit (any axis)	g _{max}			10,000	g	
ESD		-2		+2	kV	Human body model

⁽¹⁾ Maximum limits the device will withstand without damage

⁽²⁾ With 1.5V-2.5V excitation, full-scale range will be limited. So 2.8V min recommended.

OPERATING RANGES & NOISE - ACCELEROMETER

(Unless otherwise specified, all parameters are measured at 24°C @ 3.3V applied)

Measurement Range (g)	Sensitivity mV/g (±30%)	Non-Linearity (%FSO)	Residual Noise ⁽¹⁾ (mg RMS)	Spectral Noise (mg/√Hz)			
				10Hz	100Hz	1kHz	10kHz
±25	50.0	±2	2.9	0.15	0.07	0.03	0.02
±50	25.0	±2	5.9	0.29	0.13	0.05	0.05
±100	12.5	±2	11.7	0.58	0.27	0.09	0.09
±200	5.00	±2	23.2	1.16	0.53	0.18	0.18
±500	2.50	±2	58.8	2.92	1.34	0.52	0.45
±6000	0.21	±2	705	35.0	16.1	6.24	5.40

⁽¹⁾ 2Hz to 10 kHz

ELECTRICAL SPECIFICATIONS

(Unless otherwise specified, all parameters are measured at 24°C @ 3.3V applied)

Parameters	Symbol	Min	Typ	Max	Unit	Notes/Conditions
Excitation voltage	V _{dd}	3.3		5.5	Vdc	
Zero g output voltage			V _{dd} /2			50% of applied voltage
Average supply current	I _{avg}		62		µA	
Output impedance	R _{out}			100	Ω	
Warm-up time				1	Sec	

OPERATING SPECIFICATIONS - ACCELEROMETER

(Unless otherwise specified, all parameters are measured at 24°C @ 3.3V applied)

Parameter	Symbol	Min	Typ	Max	Unit	Notes/Conditions
Full scale output			±1.25		V	
0.0g output voltage (bias V)			V _{dd} /2			
Frequency response		6		10k	Hz	±1db
Frequency response		2		15k	Hz	±3db
Resonant frequency		30k			Hz	
Transverse sensitivity				8	%	
Temperature sensitivity				±8	%	-40 to 125°C Refer to typical curve
Calibration		CS-SENS-0100 NIST Traceable Amplitude Calibration at 80Hz All parts shipped with calibration data				

820M1 SINGLE AXIS ACCELEROMETER

ENVIRONMENTAL SPECIFICATIONS

Parameter	Symbol	Min	Typ	Max	Unit	Notes/Conditions
Operating temperature		-40		125	°C	
Storage temperature		-40		125	°C	
Ambient humidity		0		100	%	
Ingress protection	IP	68				Hermetic Package
Media compatibility				External exposed surfaces: Alumina Gold Au/Sn Solder		
Weight			1.2		grams	

BLOCK DIAGRAM

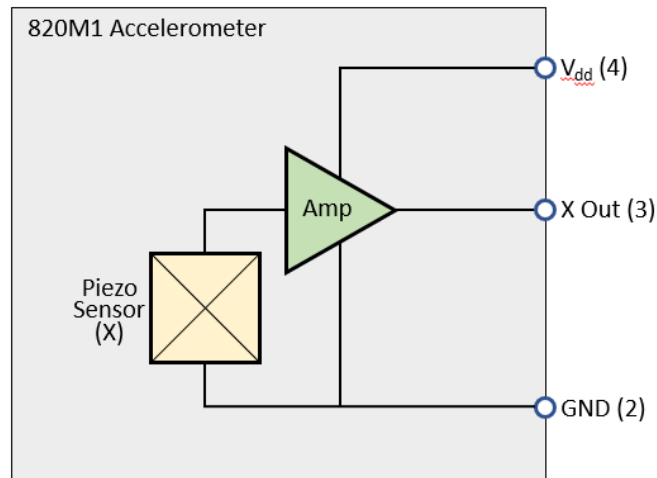

IR REFLOW TEMPERATURE PROFILE

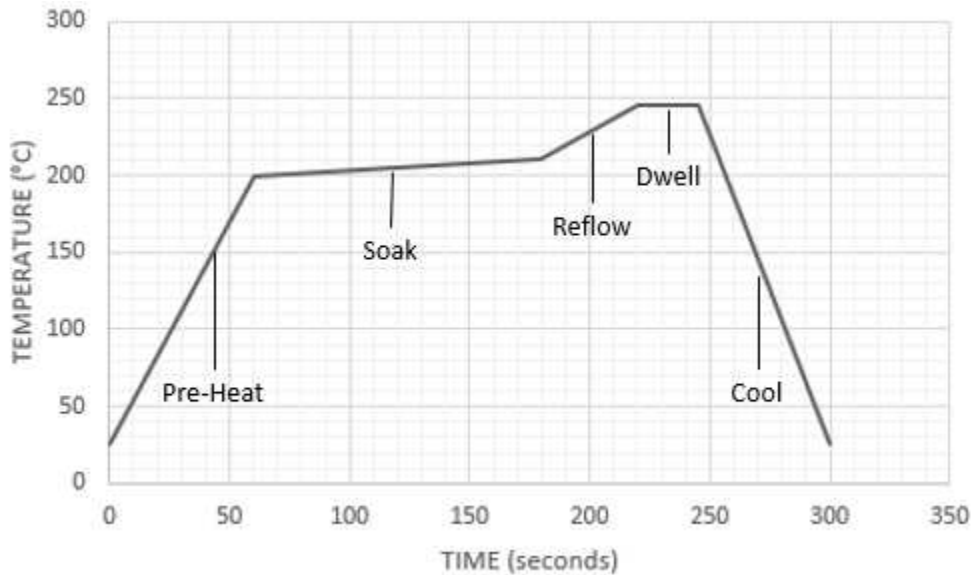

820M1 SINGLE AXIS ACCELEROMETER

DIMENSIONS

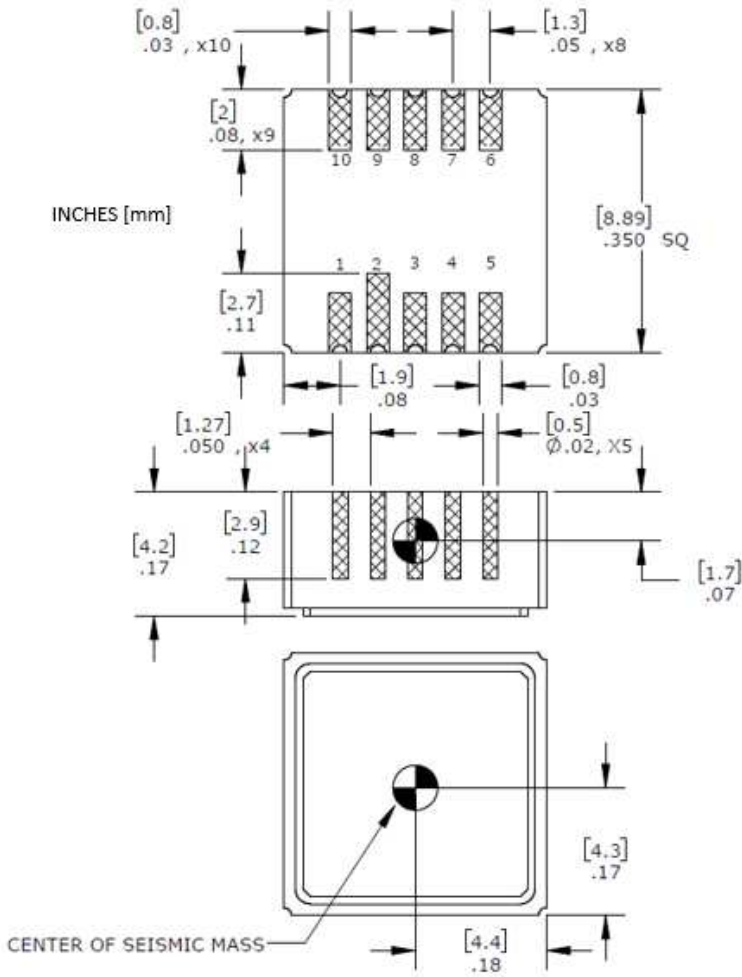

CONNECTION TABLE

Pin Number	Definition
1	N/C
2	GND
3	X axis output
4	V _{dd}
5	N/C
6	N/C
7	N/C
8	N/C
9	N/C
10	N/C

N/C connections – do not connect to the circuit

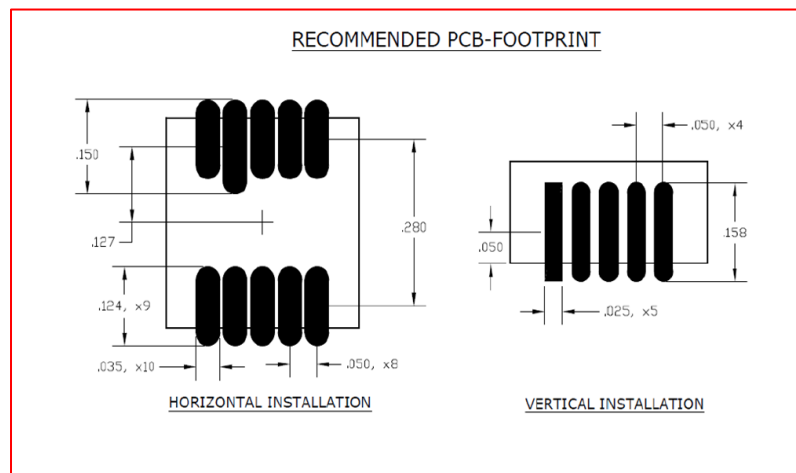

820M1 SINGLE AXIS ACCELEROMETER

TYPICAL ACCELEROMETER FREQUENCY RESPONSE CURVE

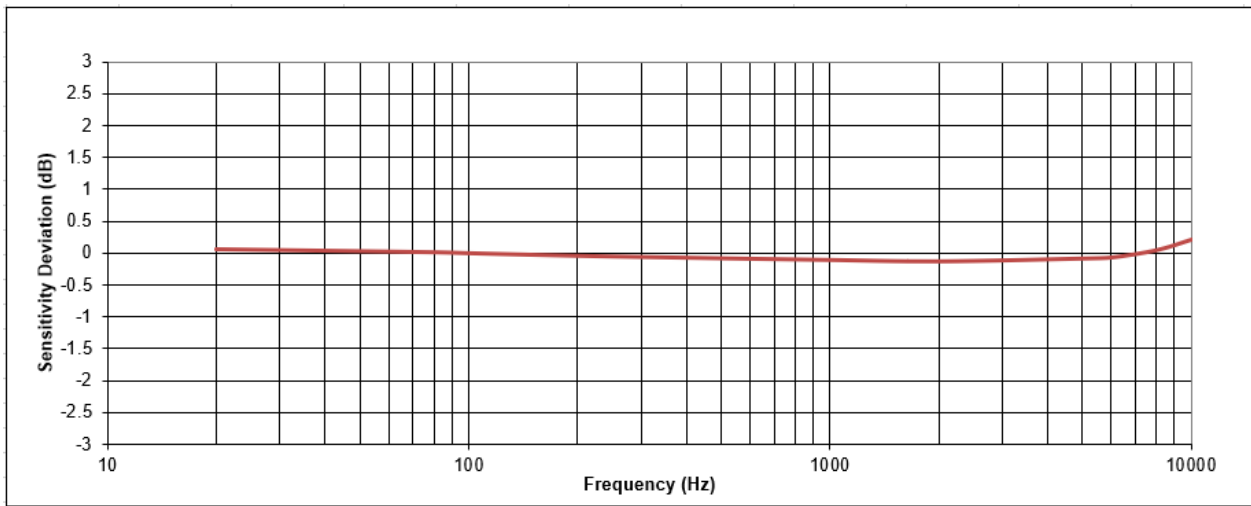

Graph 1

TYPICAL ACCELEROMETER SENSITIVITY SHIFT vs AMBIENT TEMPERATURE

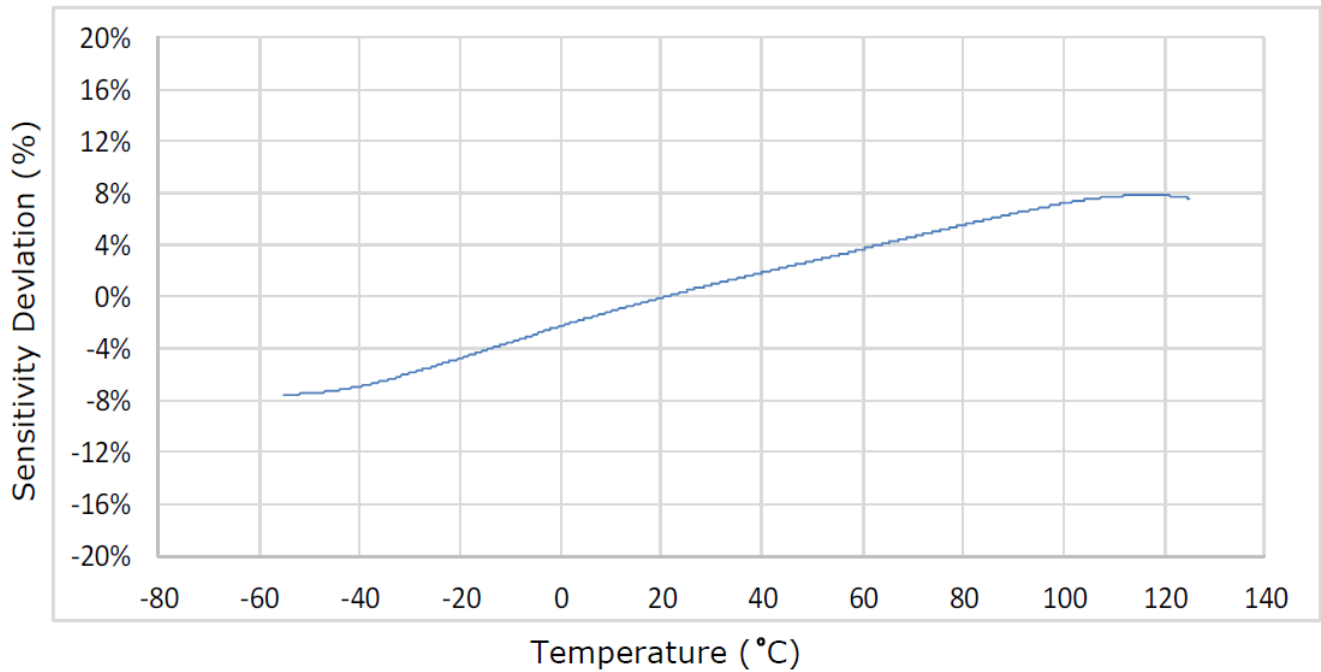

MOUNTING CONSIDERATIONS

Accelerometers are used to measure vibration and motion of various pieces of equipment and their components. To obtain the most faithful reproduction of the movements, a solid mounting method is required. The model 820M1 is designed to surface mount on a PC board with the primary attachment being the connection solder pads. Although it is recommended that several of the contacts (pins 4-6 & 10-12) not be connected to any part of the electrical circuit, mating solder pads can be added to the PC board but then left unconnected. Soldering all contacts of the accelerometer will provide the most solid mounting and best measurement results.

Rigid support for the accelerometer PC board will also help to improve the quality of measurement signals. Ultimately, the accelerometer must move at the same frequencies and displacements as the object of interest. PC board mounting that's not rigid enough will introduce unwanted noise and resonant frequencies into the measurement signal.

Figure 1 shows an example of a poorly mounted accelerometer. With no support close to the sensor, the PC board will flex and vibrate at its own resonant frequency much like a trampoline. This will introduce unwanted resonant peaks into the frequency range of interest making accurate data collection difficult.

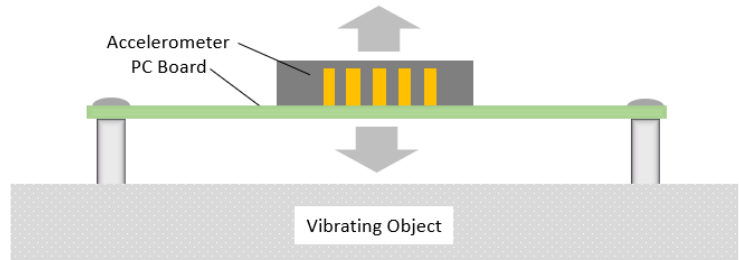

Figure 1

Figure 2 shows a better mounting design that provides support very close to the sensor and helps to eliminate unwanted vibrations and noise. If the PC board is mounted on standoffs, locate at least two standoffs as close to the accelerometer as possible. This will help stabilize the accelerometer mounting surface and help to ensure that faithful vibration and motion get transferred to the sensor.

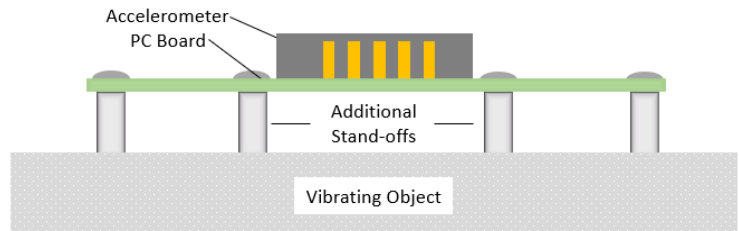

Figure 2

Figure 3 shows the addition of a rigid mounting block directly between the accelerometer PC board and the vibrating object. This design provides good coupling. Use a rigid adhesive on both mating surfaces of the block for good mechanical coupling.

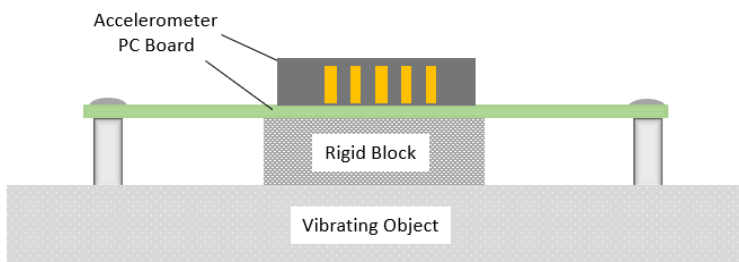

Figure 3

Figure 4 shows the PC board attached directly to the vibration source. Use a rigid adhesive to improve the transmission of high frequency vibrations and acoustic energy. Soft or elastic adhesives (pressure sensitive adhesive, RTVs, pliable glues, etc) tend to dampen and absorb higher frequency excitations. Don't use them.

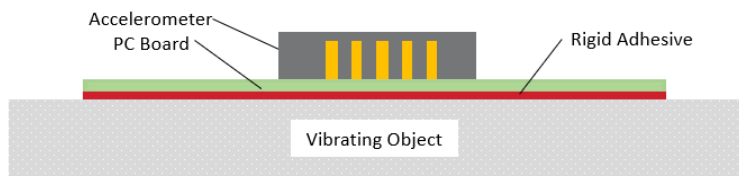

Figure 4

ORIENTATION CONSIDERATIONS

The 820M1 accelerometer is able to sense and measure motion and acceleration in a single axis only. It provides an analog voltage output that represent the acceleration magnitude. The accelerometer must be properly oriented during assembly into the application to ensure that its output will be accurate.

As shown in the detailed dimension drawing, the sensing axis is shown by an arrow on the sensor package. The sensing direction is parallel to the arrow and the closest edge of the accelerometer package. When the sensor is designed into an application, it must be oriented to align with the desired measurement direction of the customer product.

There are many places in an application where alignment errors can appear. The 820M1 is mounted on a PC board and must be carefully aligned to it. The PC board is part of a subsystem and must be carefully aligned there also. And finally, the subsystem is part of the overall product and must be aligned to that. Each of these mounting interfaces can be a source of mis-alignment errors and when summed can become significant.

For the 820M1 accelerometer, there are two types of alignment errors – rotational and tilt. Figures 5 & 6 show how these occur.

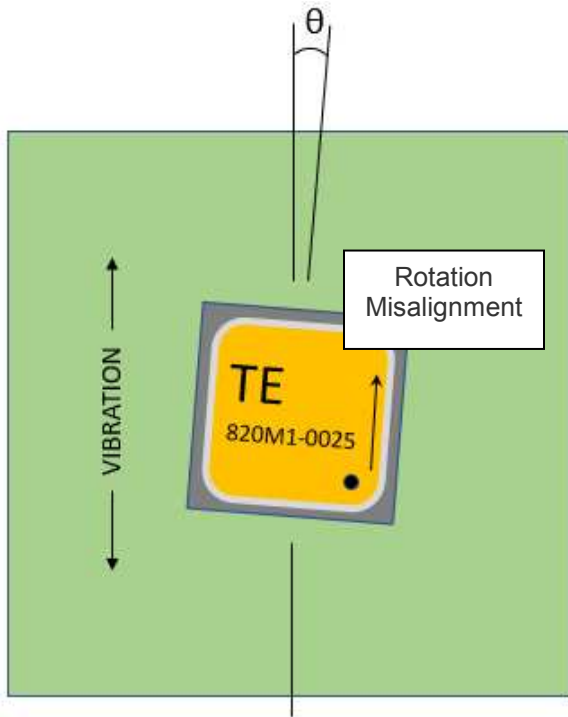

Figure 6

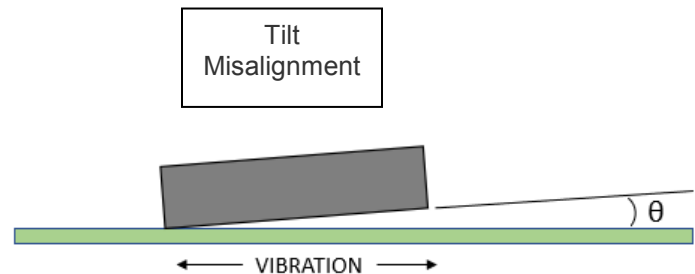

Figure 5

Both types of misalignment result in incorrect output voltages for vibration amplitude. The output error will be proportional to the cosine of the error angle θ .

In figure 5, if the acceleration or vibration is along the Y axis, a rotational misalignment error will decrease the Y axis signal by the cosine of the error angle.

In figure 6, if acceleration is along the X axis, and the sensor is tilted, then the error will decrease the X axis signal by the cosine of the error angle.

820M1 SINGLE AXIS ACCELEROMETER

PACKAGING OPTIONS

Stackable Trays – 50 pcs ea

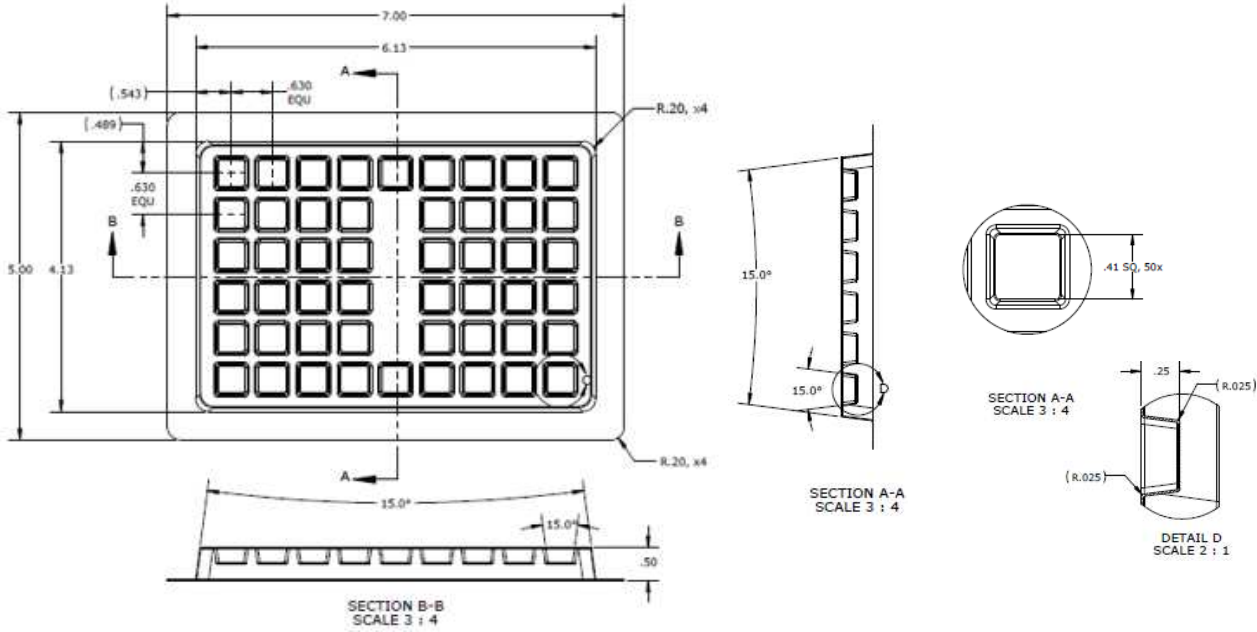

Tape & Reel

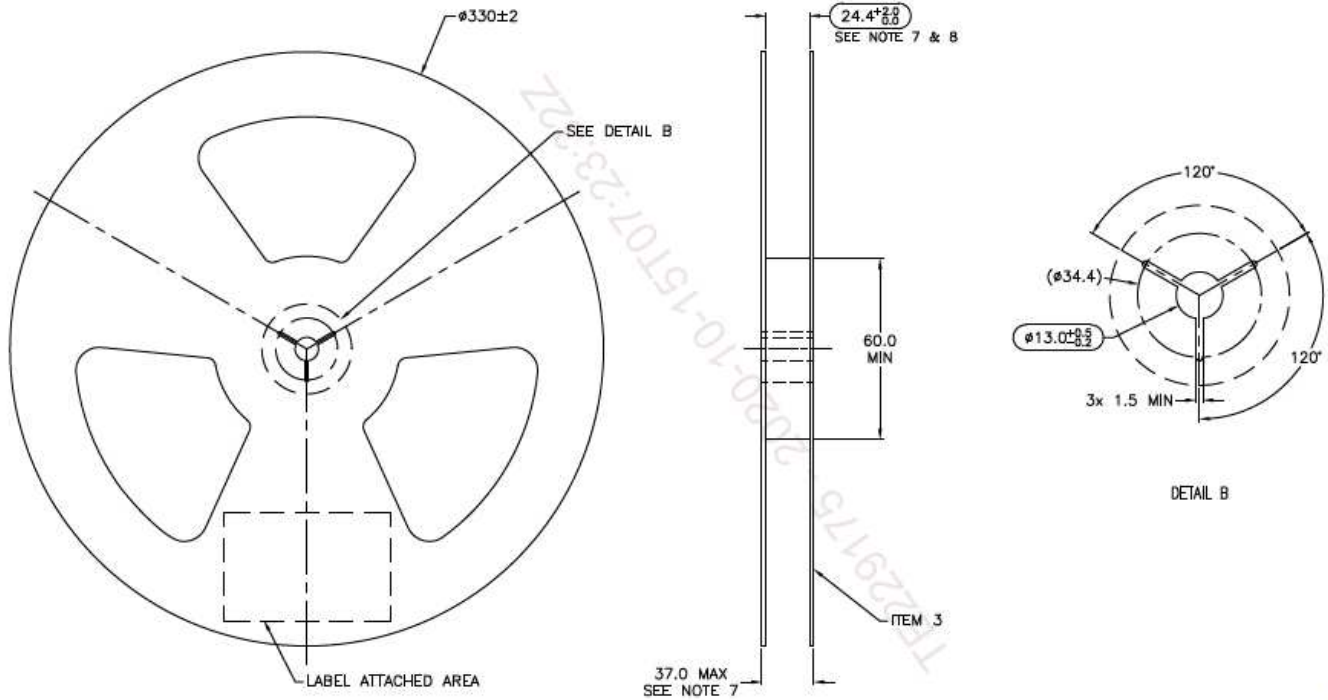

820M1 SINGLE AXIS ACCELEROMETER

ORDERING INFORMATION

820M1-xxxx

		Tray (50 pcs)	Tape & Reel (400 pcs)
0025	25g	20005836-01	20005836-00
0050	50g	20005837-01	20005837-00
0100	100g	20005838-01	20005838-00
0200	200g	20007178-01	20007178-00
0500	500g	20007179-01	20007179-00
6000	6000g	20007180-01	20007180-00

[CLICK HERE >](#)
CONNECT WITH A SPECIALIST

NORTH AMERICA
Tel +1 800 522 6752

EUROPE
Tel +31 73 624 6999

ASIA
Tel +86 0400 820 6015

te.com/sensors

TE Connectivity, TE, TE Connectivity (logo) and Every Connection Counts are trademarks. All other logos, products and/or company names referred to herein might be trademarks of their respective owners

The information given herein, including drawings, illustrations and schematics which are intended for illustration purposes only, is believed to be reliable. However, TE Connectivity makes no warranties as to its accuracy or completeness and disclaims any liability in connection with its use. TE Connectivity's obligations shall only be as set forth in TE Connectivity's Standard Terms and Conditions of Sale for this product and in no case will TE Connectivity be liable for any incidental, indirect or consequential damages arising out of the sale, resale, use or misuse of the product. Users of TE Connectivity products should make their own evaluation to determine the suitability of each such product for the specific application.

© 2021 TE Connectivity Corporation. All Rights Reserved.

Version # 05/2021



X-ON Electronics

Largest Supplier of Electrical and Electronic Components

Click to view similar products for [Accelerometers](#) category:

Click to view products by [TE Connectivity](#) manufacturer:

Other Similar products are found below :

[AD22372Z-RL7](#) [ADXL313WACPZ-RL](#) [805M1-0050-01](#) [MXC6655XA](#) [MMA7455LT](#) [805M1-0200-01](#) [810M1-0025X](#) [832M1-0200](#)
[AIS328DQTR](#) [832M1-0050](#) [805-0050](#) [AD22301](#) [BMA253](#) [ADXL354BEZ](#) [SCA620-EF8H1A-1](#) [MC3413](#) [MXC6244AU](#) [3038-0500](#) [ACH-](#)
[01-04/10](#) [4692](#) [ADXL372BCCZ-RL7](#) [735T](#) [787-500](#) [787AM8](#) [793-6](#) [793L](#) [997-M4](#) [HV101](#) [HV102](#) [HV200](#) [PC420AR-10](#) [PC420VP-50](#)
[PC420VR-10](#) [786A](#) [786A-IS](#) [787A](#) [787A-IS](#) [HT786A](#) [HT787A](#) [PC420VP-10](#) [ADCMXL1021-1BMLZ](#) [ADIS16003CCCZ](#)
[ADIS16006CCCZ](#) [ADIS16228CMLZ](#) [ADXL700WBRWZ-RL](#) [ADXL1003BCPZ](#) [ADXL103CE-REEL](#) [ADXL203CE-REEL](#) [ADXL206HDZ](#)
[ADXL213AE](#)