



Application Tooling > Insertion & Extraction Tools



Insertion & Extraction Tool Type: **Contact Insertion**

Insertion & Extraction Tool Application: **Contact-to-Housing**

Features

Product Type Features

| | |
|---|--------------------|
| Insertion & Extraction Tool Type | Contact Insertion |
| Insertion & Extraction Tool Application | Contact-to-Housing |

Product Compliance

[For compliance documentation, visit the product page on TE.com>](#)

| | |
|---|---|
| EU RoHS Directive 2011/65/EU | Compliant |
| EU ELV Directive 2000/53/EC | Out of Scope |
| China RoHS 2 Directive MIIT Order No 32, 2016 | No Restricted Materials Above Threshold |
| EU REACH Regulation (EC) No. 1907/2006 | Current ECHA Candidate List: JUL 2021 (219) Candidate List Declared Against: JUL 2021 (219) Does not contain REACH SVHC |
| Halogen Content | Low Halogen - Br, Cl, F, I < 900 ppm per homogenous material. Also BFR/CFR/PVC Free |
| Solder Process Capability | Not reviewed for solder process capability |

Product Compliance Disclaimer

This information is provided based on reasonable inquiry of our suppliers and represents our current actual knowledge based on the information they provided. This information is subject to change. The part numbers that TE has identified as EU RoHS compliant have a maximum concentration of 0.1% by weight in homogenous materials for lead, hexavalent chromium, mercury, PBB, PBDE, DBP, BBP, DEHP, DIBP, and 0.01% for cadmium, or qualify for an exemption to these limits as defined in the Annexes of Directive 2011/65/EU (RoHS2). Finished electrical and electronic equipment products will be CE marked as required by Directive 2011/65/EU. Components may not be CE marked. Additionally, the part numbers that TE has identified as EU ELV compliant have a maximum concentration of 0.1% by weight in homogenous materials for lead, hexavalent chromium, and mercury, and 0.01% for cadmium, or qualify for an exemption to these limits as defined in the Annexes of Directive 2000/53/EC (ELV). Regarding the REACH Regulation, the information TE provides

on SVHC in articles for this part number is based on the latest European Chemicals Agency (ECHA) 'Guidance on requirements for substances in articles' posted at this URL: <https://echa.europa.eu/guidance-documents/guidance-on-reach>

Compatible Parts



TE Part # CAT-AM71-T98
TYPE II CONTACTS



TE Part # CAT-AM71-T98D
TYPE III CONTACTS LP EMEA



TE Part # CAT-AM71-T98E
TYPE III CONTACTS LP



TE Part # CAT-AM71-T98A
TYPE III CONTACTS LP



TE Part # CAT-AM71-T98G
TYPE III CONTACTS LP HIGH CURRENT



TE Part # CAT-AM71-T98B
TYPE III CONTACTS STRIP



TE Part # CAT-AM71-T98F
TYPE III CONTACTS STRIP HIGH CURRENT



TE Part # CAT-AM71-T98C
TYPE III CONTACTS STRIP EMEA



TE Part # 66361-1
III+ PIN,18-14,30AU>10,LP



TE Part # 66099-1
III+ PIN,18-16,30AU>10,LP



TE Part # 1-66105-8
III+ SKT,24-20,30AU/FL,SMPACK



TE Part # 66105-2
III+ SKT,24-20,TIN-LEAD,LP



TE Part # 66103-2
III+ PIN,24-20,TIN-LEAD,LP



TE Part # 66358-6
III+ SKT,18-14,TIN-LEAD,STRIP



TE Part # 66101-2
III+ SKT,18-16,TIN-LEAD,LP



TE Part # 66601-1
III+ SKT,18-14,TIN-LEAD,LP



Also in the Series | AMP Type II

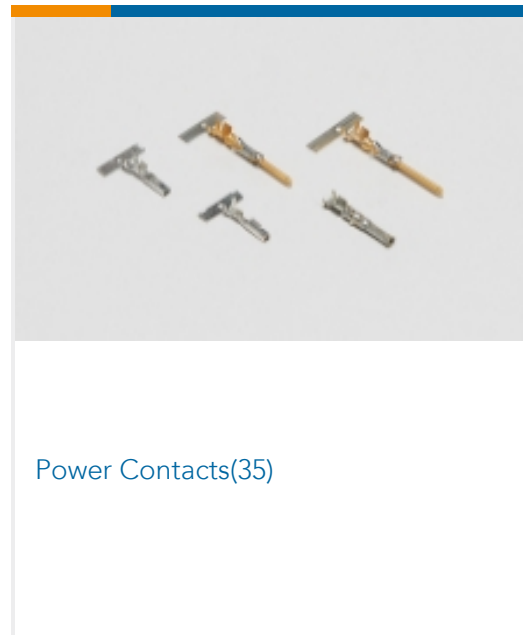
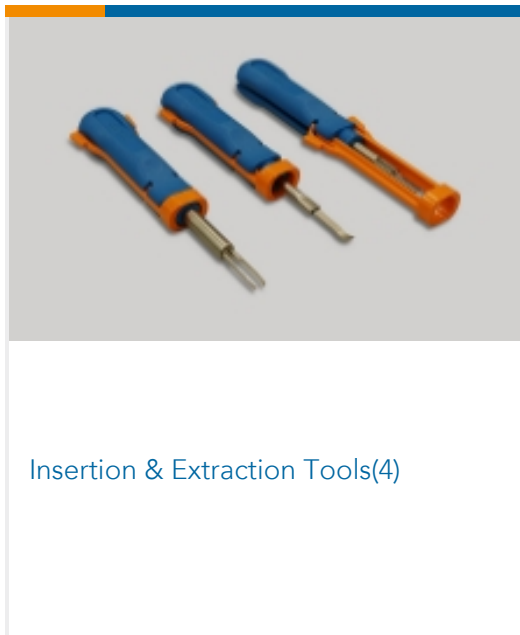

Also in the Series | AMP Type III+

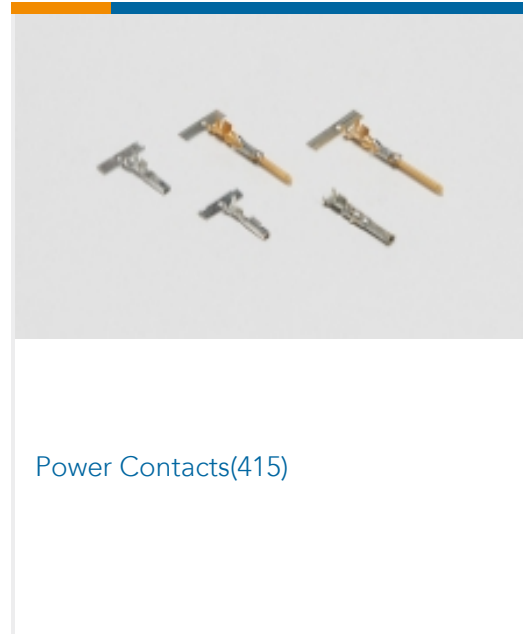
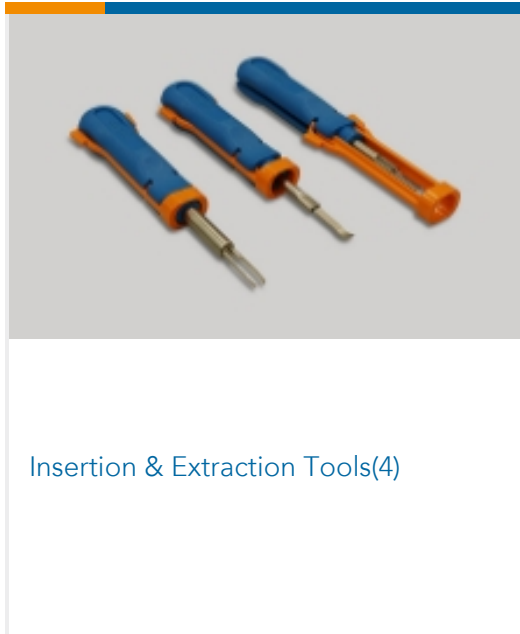

Customers Also Bought



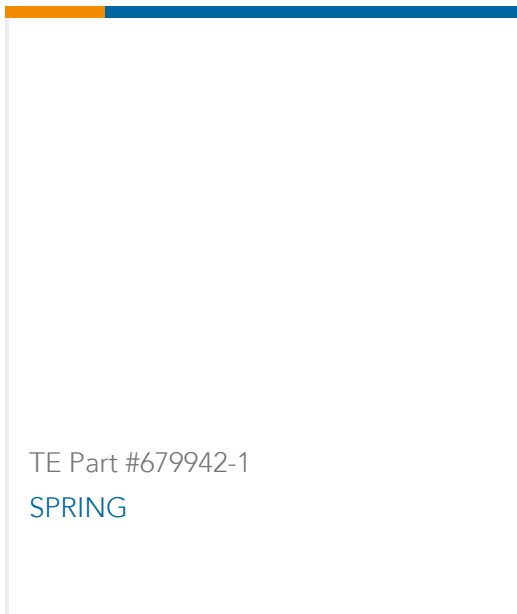
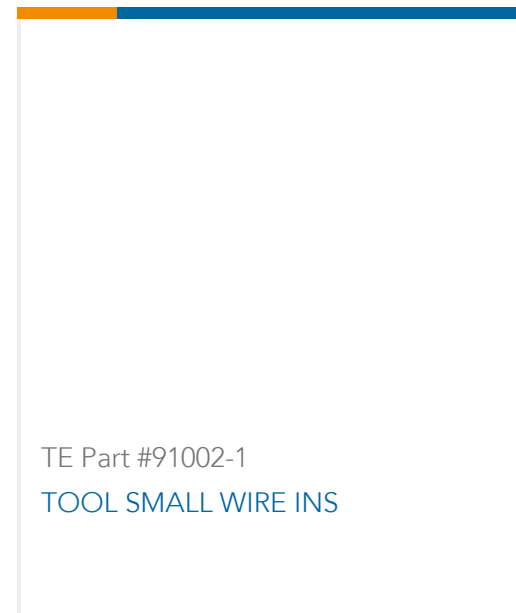
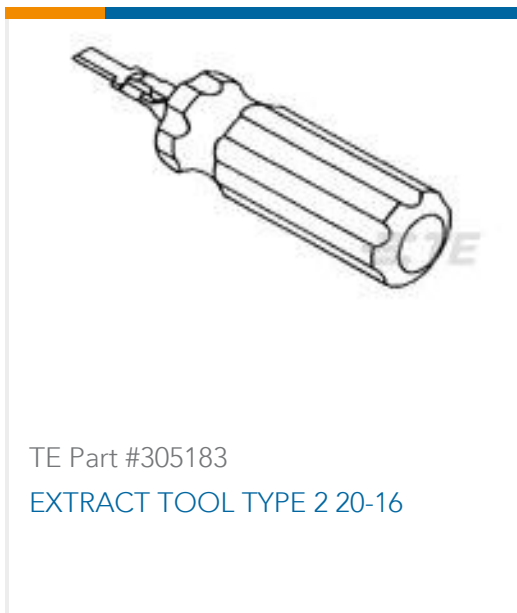

Documents

Datasheets & Catalog Pages

[Crimp Term Whitepaper-Use the Right Tool 1-1773953-1](#)

English

[CRIMPING WHERE FORM MEETS FUNCTION](#)

English

[Insertion-Extraction-Tool-2345721-1](#)

English

Instruction Sheets

[Instruction Sheet \(U.S.\)](#)

English

[Insertion Tool](#)

English

Agency Approvals

[CSA Certificate](#)

English

X-ON Electronics

Largest Supplier of Electrical and Electronic Components

Click to view similar products for [Extraction, Removal & Insertion Tools](#) category:

Click to view products by [TE Connectivity](#) manufacturer:

Other Similar products are found below :

[M8196914-08](#) [768211-2](#) [809-131](#) [844751-2](#) [8-59558-2](#) [91018-1](#) [12014013](#) [12093647](#) [1-21048-0](#) [R282867020](#) [12093078](#) [1-21048-6](#)
[12121897](#) [DCF.91.405.5LT](#) [1322](#) [15314260](#) [15350698](#) [15350707](#) [15430130](#) [1579018-4](#) [1643916-1](#) [1-679532-0](#) [1976593-3](#) [OUTEXT-0321](#)
[2-1579008-3](#) [2-1579008-4](#) [229694-7](#) [231106-1](#) [241469](#) [91040-3](#) [91040-7](#) [965004-000](#) [965069-000](#) [1738219-1](#) [ET-JL05-16](#) [FG 0300 146](#)
[3000](#) [FIT-6](#) [210S048](#) [2-1579007-9](#) [231879-1](#) [312138-3](#) [RJ11FODE](#) [356-162](#) [M8196914-10](#) [4-1579018-0](#) [430395-001](#) [483249-1](#) [5-](#)
[1579007-2](#) [5-1579007-9](#) [BPR10](#)