

THIS DRAWING IS UNPUBLISHED. RELEASED FOR PUBLICATION APR, 2008.

© COPYRIGHT 2008 BY TYCO ELECTRONICS CORPORATION. ALL RIGHTS RESERVED.

LOC	DIST	REVISIONS		
J		変更		
P	LTR	DESCRIPTION	DATE	DWN
	A1	RELEASED ECR-18-019397	29SEP2019	J.J W.H

引き出し方向  
USER DIRECTION OF FEED

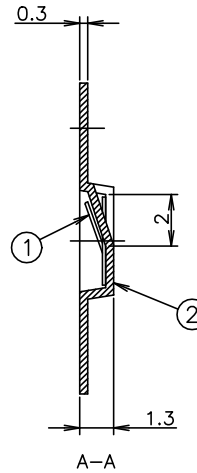
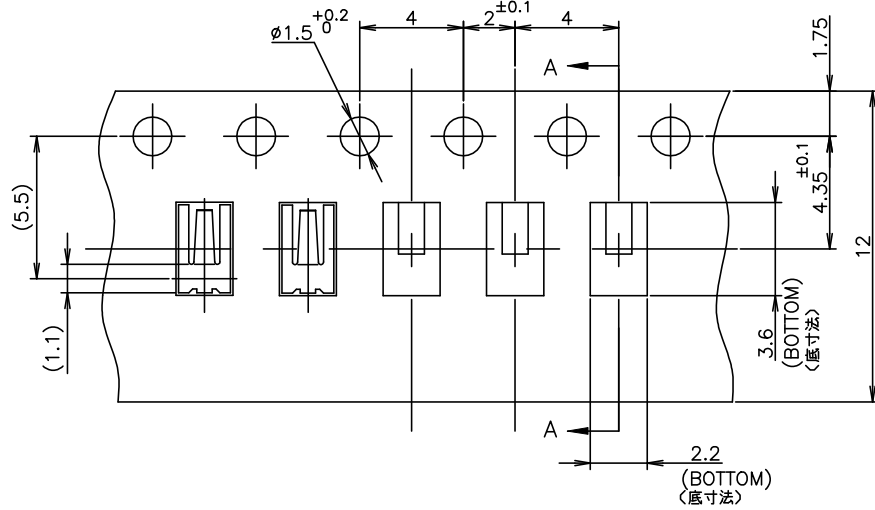

- 1 GENERAL TOLERANCE:  $\pm 0.3$
- 2 PACKING STYLE: 10000PCS/REEL
- 3 MATERIAL:  
SHIELD FINGER: COPPER ALLOY (NICKEL-PLATING)  
(Au PL. 0.00005 MIN.)  
(SOLDER-PLATING ON THE BOTTOM PLANE ONLY)

- CARRIER TAPE: ACRYLIC FILM
- TOP TAPE: PET FILM
- REEL: PLASTIC
- 4 TAPES DIMENSION

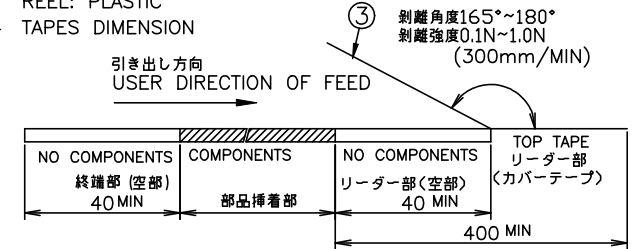

- 5 REEL DIMENSION: REFERENCE ONLY

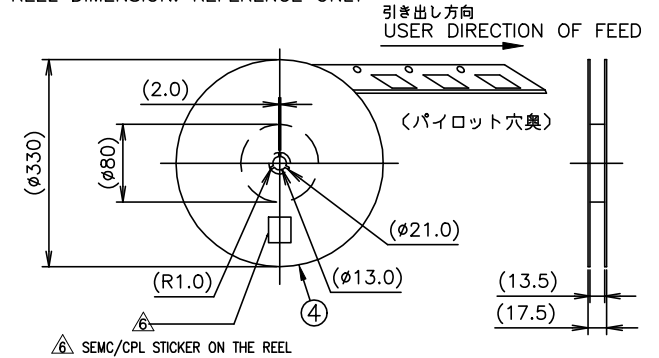

シールドフィンガー0820  
SHIELD FINGER 0820  
SCALE 10:1

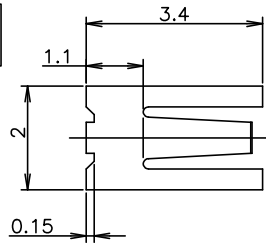

RECOMMENDED FOOT PRINT  
REFERENCE ONLY  
(GENERAL TOLERANCE  $\pm 0.1$ )  
参考パッド寸法 (公差 $\pm 0.1$ )

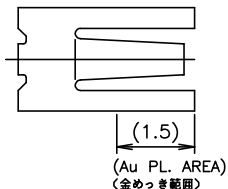
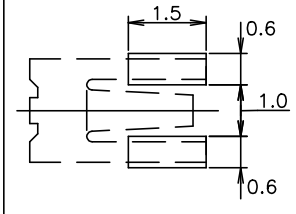

2040852-1	④	REEL	リール	1
	③	COVER TAPE	カバーテープ	1
	②	EMBOSS CARRIER TAPE	エンボスキャリアテープ	10000 POKETS (COMPONENTS)
	①	SHIELD FINGER 0820	シールドフィンガー0820	10000 PCS
PACKING CAT.NO.	NO.	NAME	名称	QUANTITY

THIS DRAWING IS A CONTROLLED DOCUMENT.		DWN	16JUL2008	Tyco Electronics Corporation	
		CHK	16JUL2008	Kawasaki, Japan	
		APVD	16JUL2008	SHIELD FINGER 0820	
DIMENSIONS: 単位: 寸 mm		TOLERANCES UNLESS OTHERWISE SPECIFIED: 一般公差		NAME 名称	
0 PLC $\pm$		1 PLC $\pm$ SEE NOTE		SIZE	
2 PLC $\pm$		3 PLC $\pm$		CAGE CODE	
4 PLC $\pm$		ANGLES $\pm$		DRAWING NO 番号	
MATERIAL 材料		FINISH 仕上		RESTRICTED TO	
		WEIGHT		A300779	
		CUSTOMER DRAWING		SCALE 尺度 5:1	
				SHEET 1 of 1	
				REV A1	

## X-ON Electronics

Largest Supplier of Electrical and Electronic Components

*Click to view similar products for [EMI Gaskets, Sheets, Absorbers & Shielding](#) category:*

*Click to view products by [TE Connectivity](#) manufacturer:*

Other Similar products are found below :

[8101010140](#) [8563-0090-89](#) [1194-7.7X10](#) [1245-34"X18YD](#) [1267](#) [1345-3/8x18yrd](#) [1554907-1](#) [2320002000](#) [2320014700](#) [SG293037DS](#)  
[ST005PCN50](#) [55005107](#) [38M4040AA0606](#) [46J5N02020.NN00](#) [1125-8X10](#) [1126X1"](#) [1170-3/4X18YDS](#) [1170-7.7x10](#) [1183-12"X18YD](#) [6-](#)  
[34T-BD-0.315](#) [SG125187D-24](#) [SG125250R-24](#) [SG187375R-24](#) [SG284050DS](#) [8402010540](#) [KIT TECH CLIP](#) [10-40450-28S](#) [1245](#) [1267-](#)  
[1/2"x18yd](#) [46J8501020.NN00](#) [1170-1/4"x18yd](#) [AL-36FR-1x54.5](#) [3013310A](#) [1194X1"](#) [3020604](#) [3021302](#) [3031313](#) [260709](#) [3021310](#) [6-](#)  
[34UT-070-BD-16](#) [303076048](#) [46J5N03020.NN00](#) [30206025](#) [30395641](#) [3030403](#) [3690103020](#) [HNY-LT15CU4241](#) [46X7503020.NN00](#)  
[46W5E02520.NN00](#) [302095032](#)