

| REVISIONS | | | | |
|-----------|-----|---------------------------|-----------|-------|
| P | LTR | DESCRIPTION | DATE | APVD |
| E2 | | REVISED PER ECO-15-014756 | 13OCT2015 | DD JS |

LEVER IN PRE-STAGE POSITION

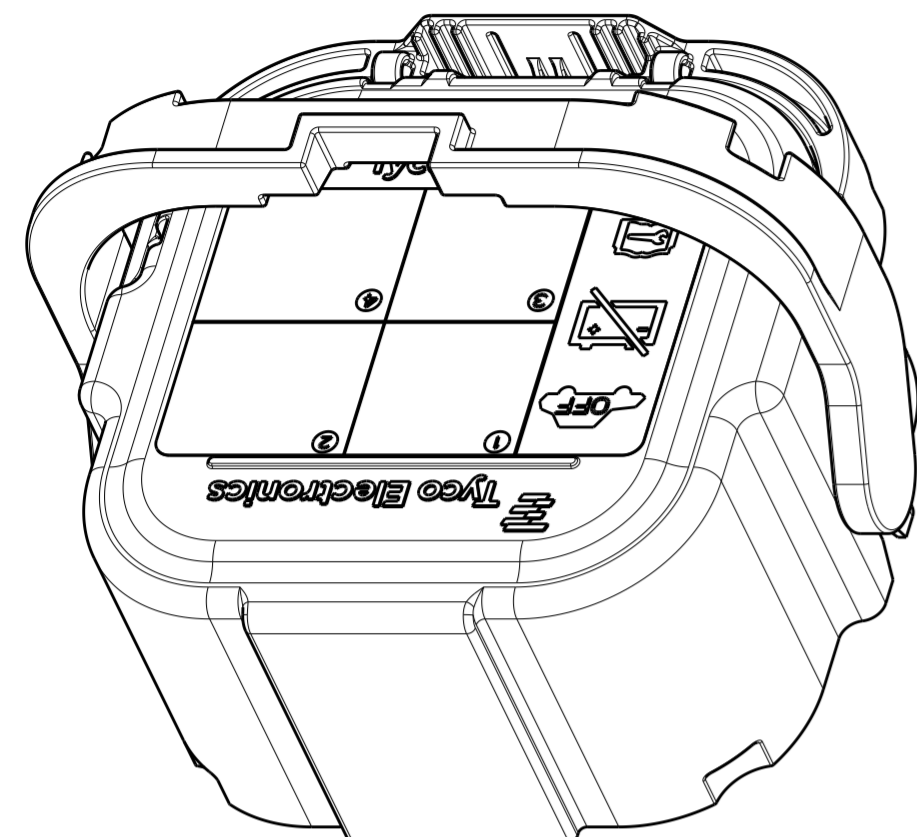

ISOMETRIC VIEW
SCALE 1:1

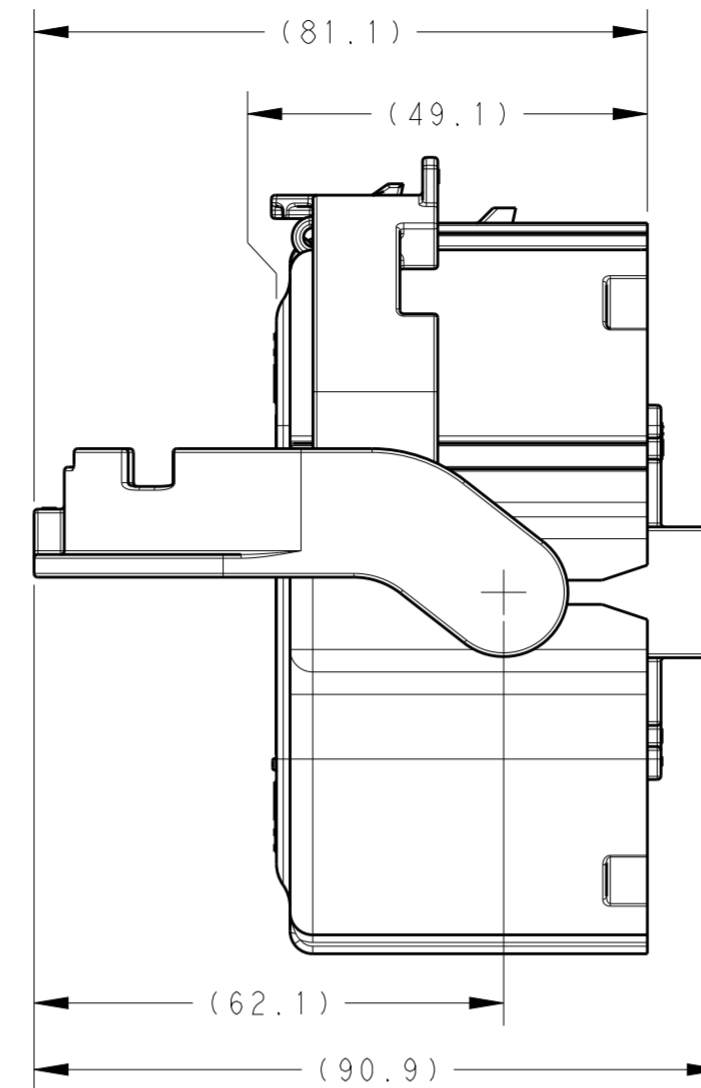
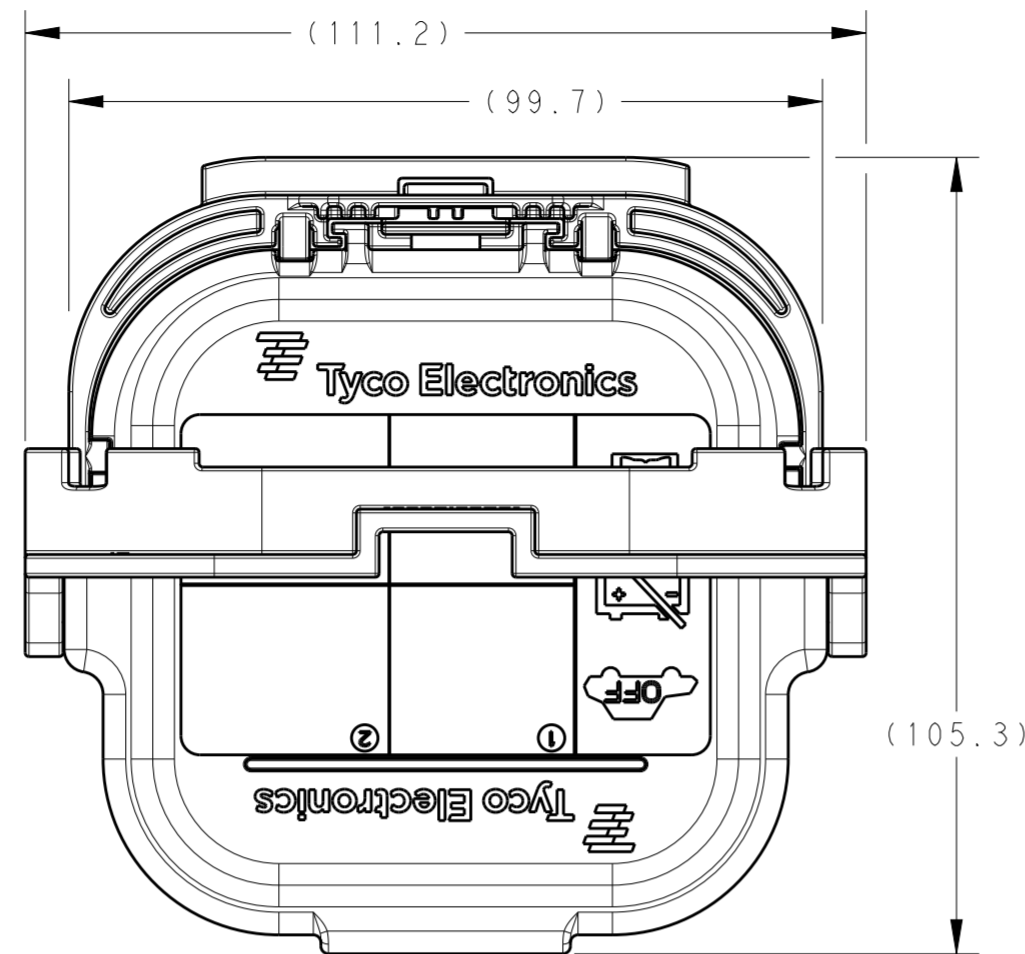

LEVER IN LOCKED POSITION

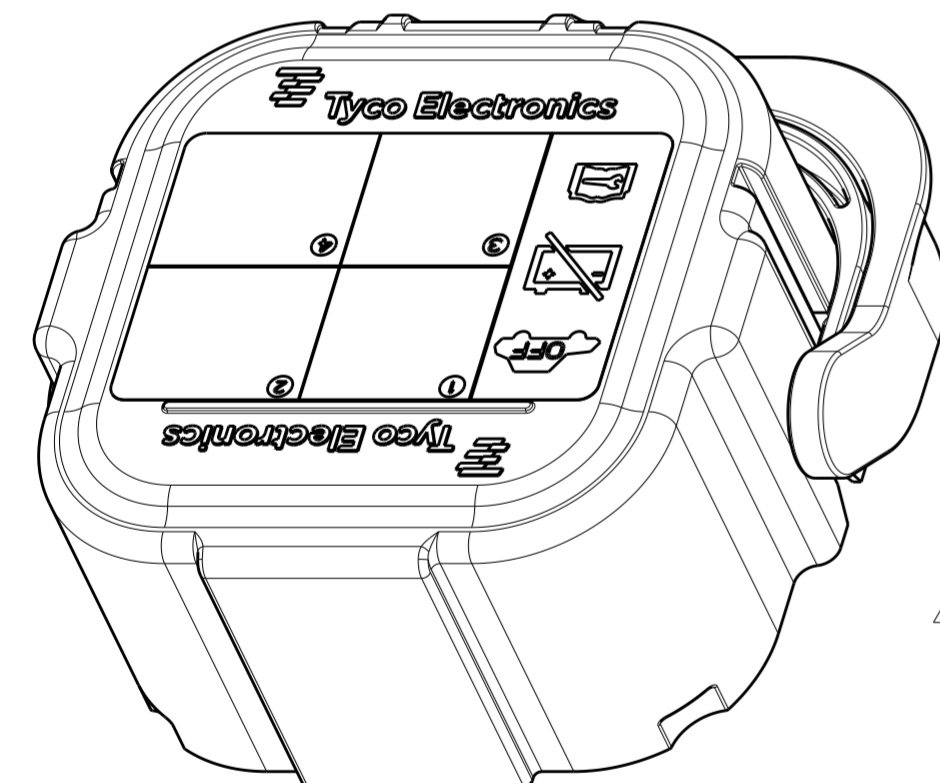

ISOMETRIC VIEW
SCALE 1:1

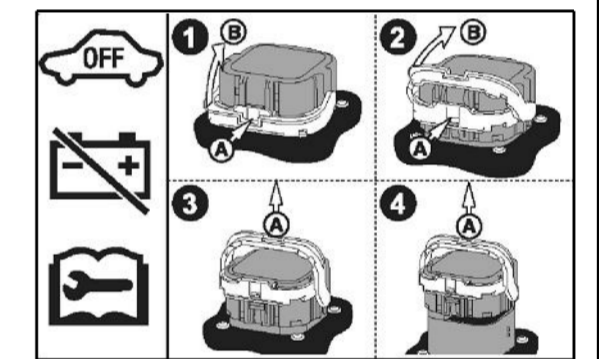
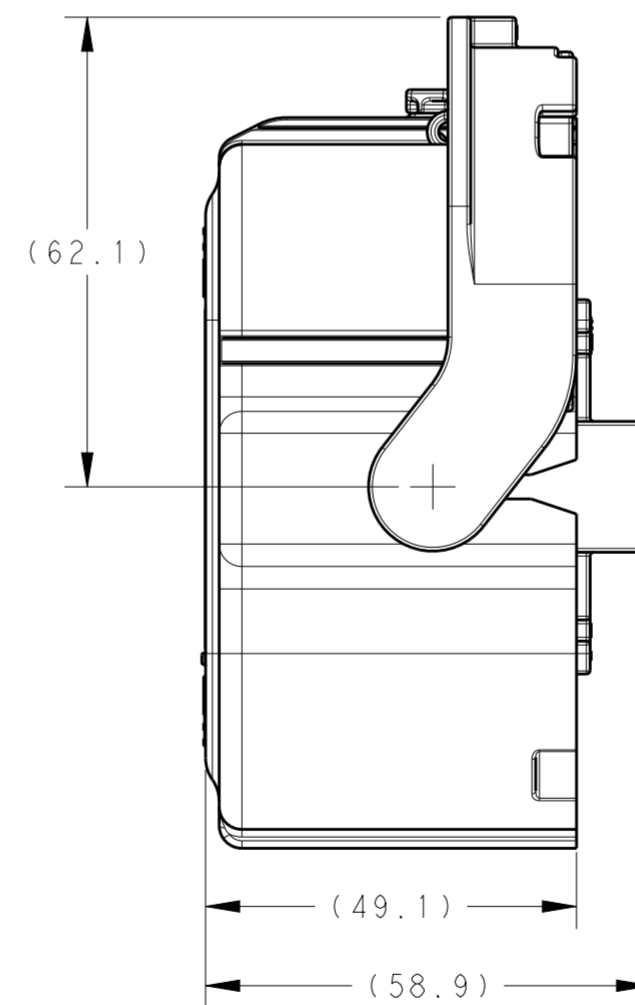
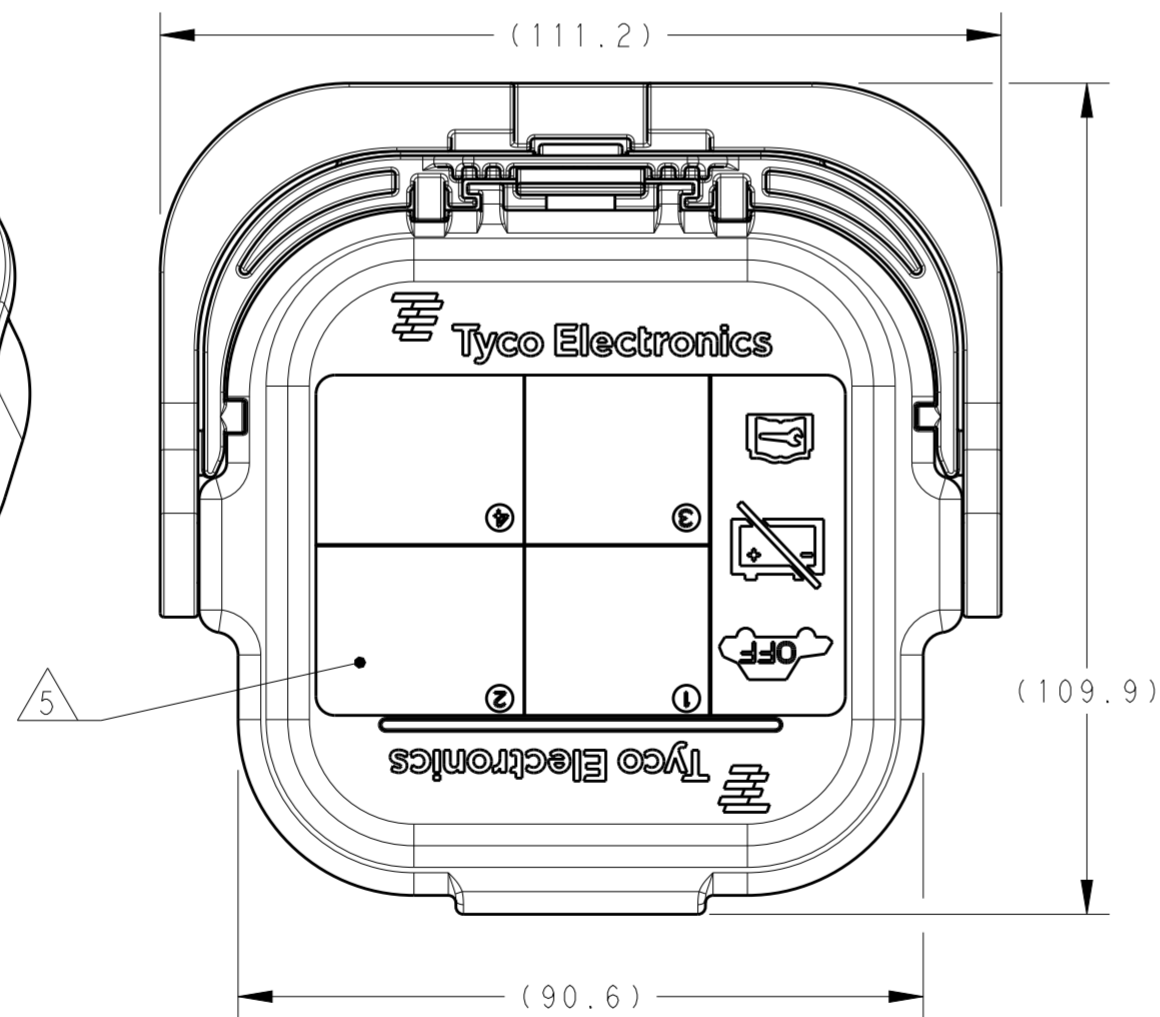

| INNER LEVER COLOR | PART WEIGHT (g) | FUSE RATING | PART NO. |
|-------------------|-----------------|-------------|-------------|
| NATURAL/OFF-WHITE | 261.25 | SHUNT | 2-2103212-7 |
| NATURAL/OFF-WHITE | 525.60 | 350A (EV) | 2-2103212-2 |
| BLACK | 525.60 | 350A (EV) | 2-2103212-1 |
| NATURAL/OFF-WHITE | 525.60 | 250A (EV) | 1-2103212-9 |
| NATURAL/OFF-WHITE | 525.60 | 200A (EV) | 1-2103212-8 |
| BLACK | 261.25 | SHUNT | 1-2103212-7 |
| BLACK | 525.60 | 350A | 1-2103212-2 |
| NATURAL/OFF-WHITE | 525.60 | 350A | 1-2103212-1 |
| BLACK | 525.60 | 250A | 2103212-9 |
| BLACK | 525.60 | 200A | 2103212-8 |

- ① INNER HOUSING MAY BE ASSEMBLED ROTATED 180° FROM AS SHOWN.
- ② ASSEMBLY / WORK INSTRUCTIONS: 408-10432
PRODUCT SPECIFICATION: 108-127000
APPLICATION SPECIFICATION: 501-127000
- ③ NOTE DELETED.
- ④ SEE TABLE AND SHEET 2 FOR FUSE RATINGS AND KEYING.
- ⑤ IMAGE FOR REFERENCE ONLY, SHOWS LABEL ORIENTATION.
- ⑥ ACTUAL APPEARANCE OF LABEL.

THIS DRAWING IS A CONTROLLED DOCUMENT. DIMENSIONING AND TOLERANCING PER ASME Y14.5M-2009

| DIMENSIONS: | TOLERANCES UNLESS OTHERWISE SPECIFIED: |
|-------------|--|
| mm | |
| 0 PLC | ± |
| 1 PLC | ± |
| 2 PLC | ± |
| 3 PLC | ± |
| 4 PLC | ± |
| ANGLES | ± |
| FINISH | |

| | | |
|------------------|-----------|-----------|
| DWN | A BOYER | 14JUL2011 |
| CHK | A BOYER | 14JUL2011 |
| APVD | A GUANCO | 14JUL2011 |
| PRODUCT SPEC | | ② |
| APPLICATION SPEC | | ② |
| WEIGHT | SEE TABLE | |
| CUSTOMER DRAWING | | |

| | | | |
|-----------------|-----------|--|---------------|
| TE Connectivity | | NAME | |
| | | PLUG ASSEMBLY MANUAL SERVICE DISCONNECT | |
| SIZE | CAGE CODE | DRAWING NO. | RESTRICTED TO |
| A200779 | C-2103212 | | |
| SCALE | 1:1 | SHEET | 1 OF 2 |
| REV | E2 | | |

| REVISIONS | | | | |
|-----------|-----|-------------|------|------|
| P | LTR | DESCRIPTION | DATE | APVD |
| - | - | SEE SHEET 1 | - | - |
| | | | | |
| | | | | |

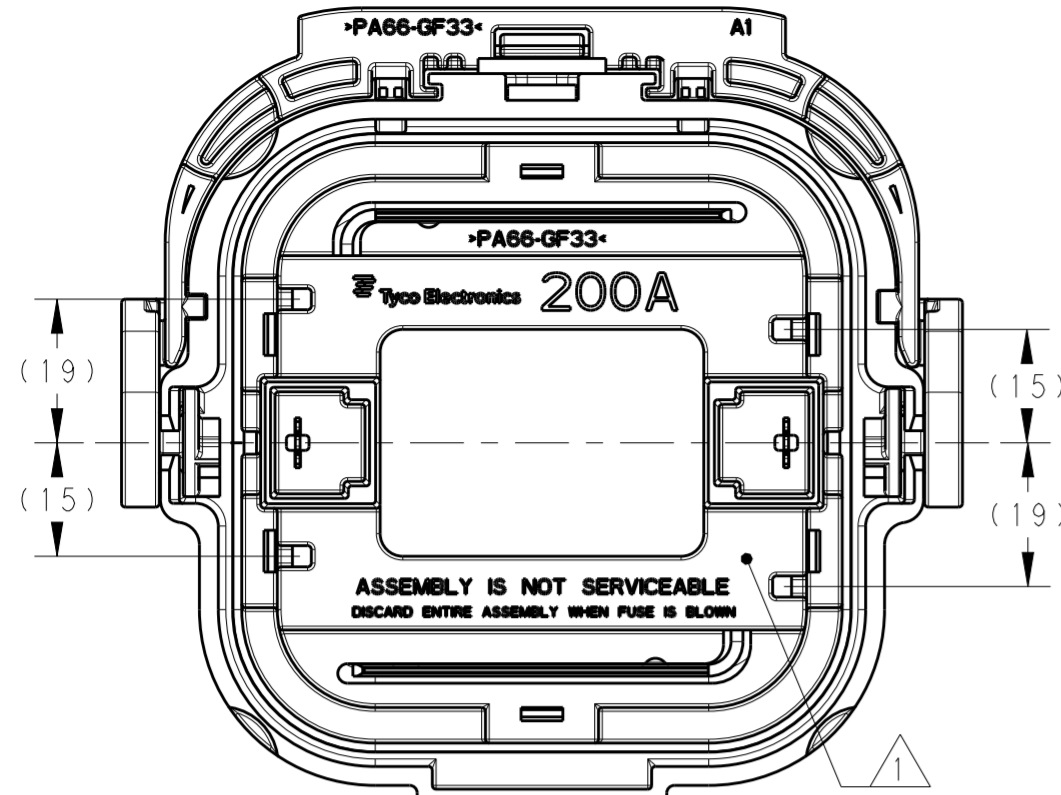

2103212-8 & 1-2103212-8
 FUSE RATING: 200A

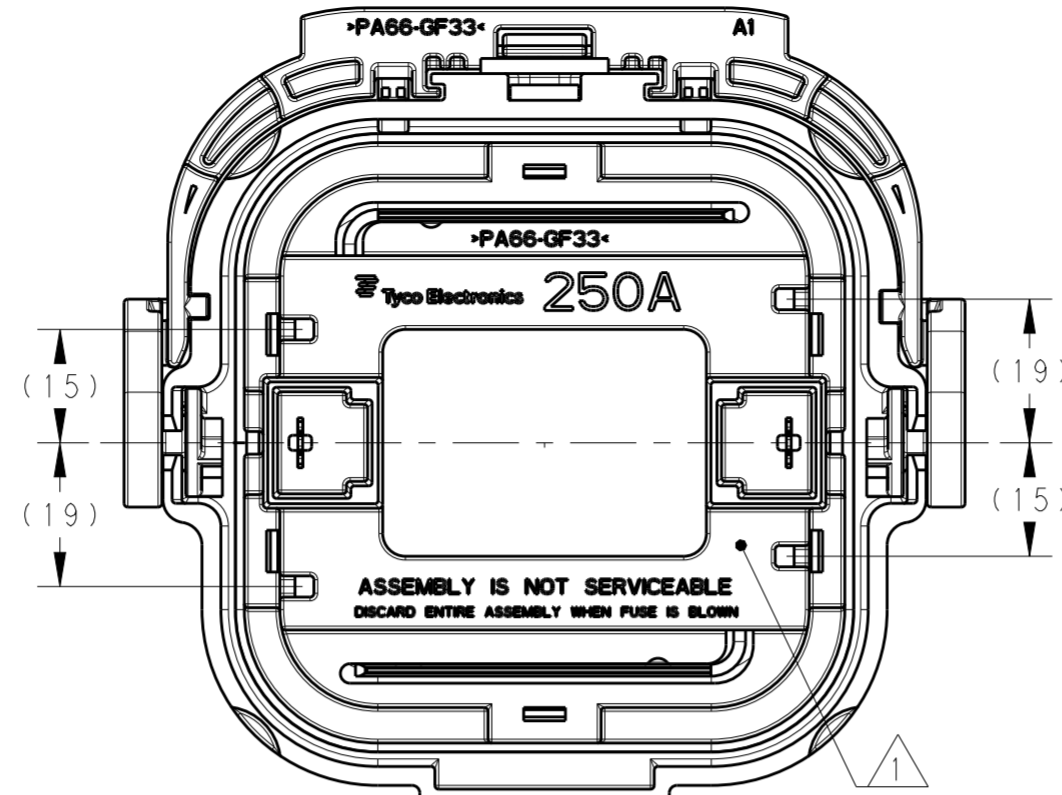

2103212-9 & 1-2103212-9
 FUSE RATING: 250A

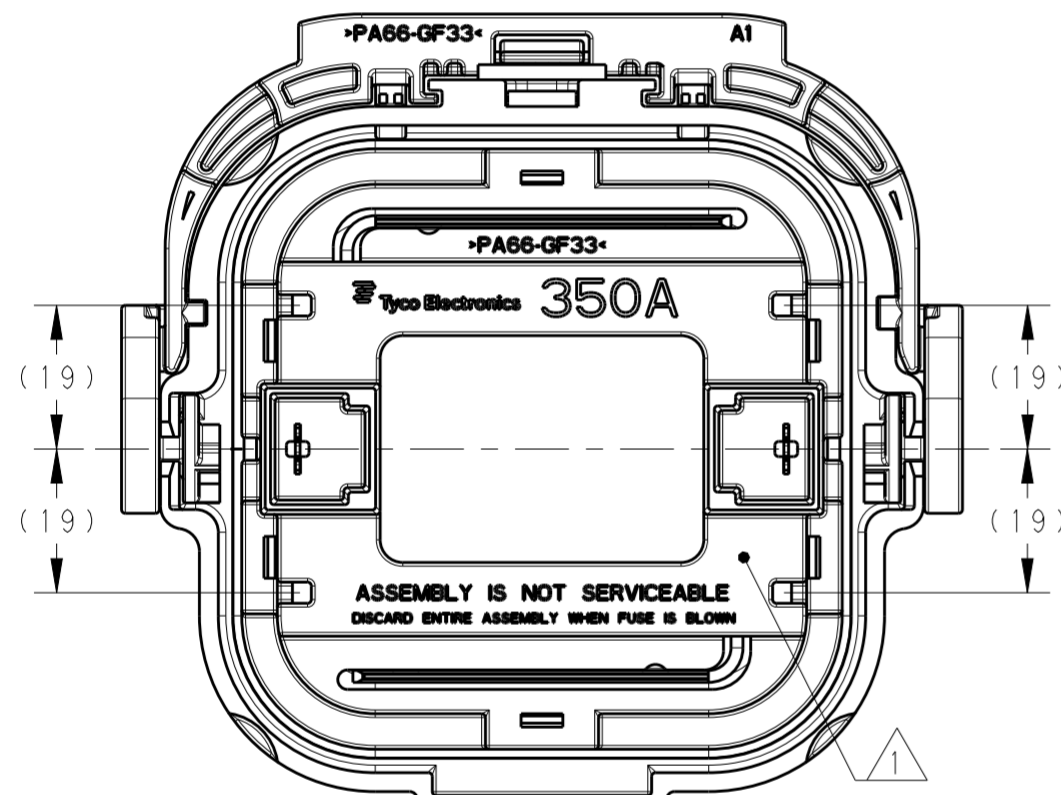

1-2103212-1, 1-2103212-2, 2-2103212-1
 & 2-2103212-2
 FUSE RATING: 350A

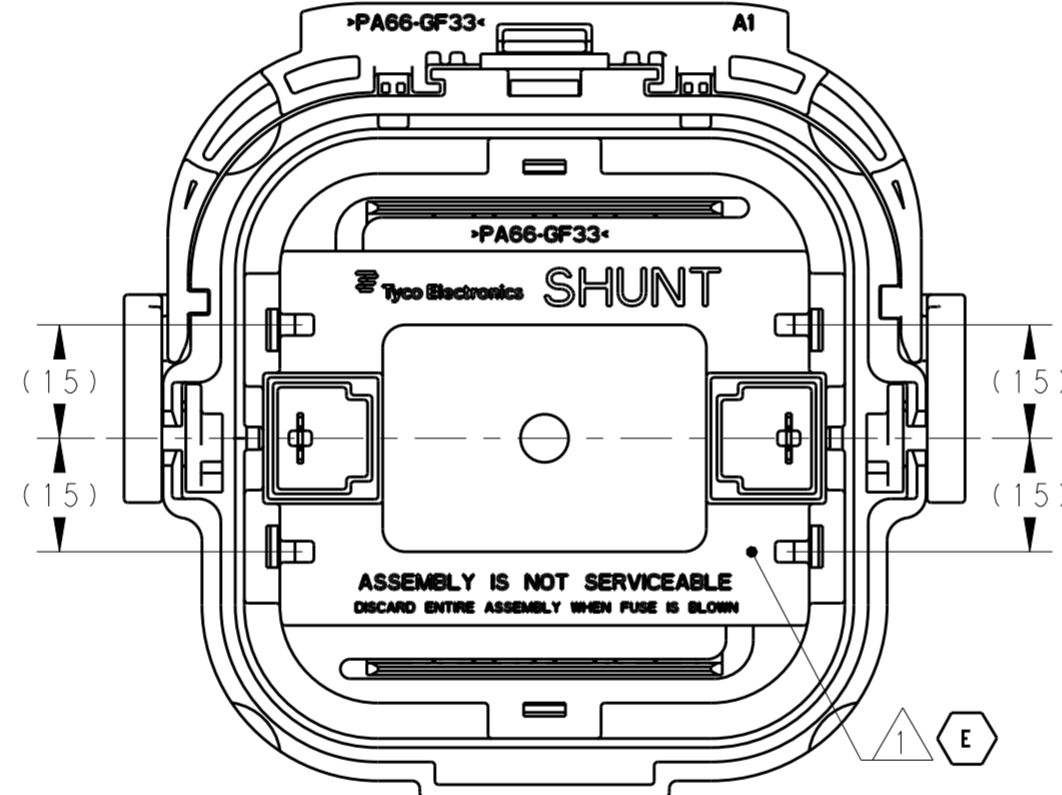

1-2103212-7 & 2-2103212-7
 SHUNT

| | | | | | | |
|---|---|---------------------------------|---|--|-----------|---------------|
| THIS DRAWING IS A CONTROLLED DOCUMENT. DIMENSIONING AND TOLERANCING PER ASME Y14.5M-2009. | | DWN A BOYER 14 JUL 2011 |  TE Connectivity | NAME | | |
| DIMENSIONS: mm | | CHK A BOYER 14 JUL 2011 | | PLUG ASSEMBLY MANUAL SERVICE DISCONNECT | | |
| TOLERANCES UNLESS OTHERWISE SPECIFIED: | | APVD A GUANCO 14 JUL 2011 | | SIZE | CAGE CODE | DRAWING NO |
| 0 PLC ± 1 PLC ± 2 PLC ± 3 PLC ± 4 PLC ± ANGLES ± FINISH - | | PRODUCT SPEC - | | A200779 | C-2103212 | RESTRICTED TO |
| MATERIAL | - | APPLICATION SPEC - | WEIGHT | SEE TABLE | SCALE 1:1 | |
| CUSTOMER DRAWING | | REVISIONS | SHEET 2 OF 2 | REV E2 | | |

X-ON Electronics

Largest Supplier of Electrical and Electronic Components

Click to view similar products for [Automotive Connectors](#) category:

Click to view products by [TE Connectivity](#) manufacturer:

Other Similar products are found below :

[003-018-000](#) [60403001](#) [60993906-B](#) [M902-2131](#) [M902-2161](#) [M902-2344](#) [72.330.1035.1](#) [73.353.4028.0](#) [F119300-B](#) [F166900](#) [F258300-B](#)
[F358300-B](#) [F407400](#) [F444110](#) [F487000](#) [F509500B-B](#) [827153-1](#) [8N1515-32-24P](#) [9-1326729-8](#) [925474-1](#) [928905-1](#) [964562-4](#) [968782-1](#)
[GT17SA-8DS-HU](#) [98891-1012](#) [98947-1016](#) [12004147](#) [12004475-L](#) [12010290](#) [12010309-B](#) [12015454](#) [12020219-B](#) [12041318-B](#) [12052225-](#)
[L](#) [12052466](#) [12064869](#) [12004327-B](#) [12015308](#) [12015384](#) [12015909](#) [1-21030-1](#) [12041254](#) [12041318](#) [12047946-B](#) [12047957](#) [12047957-L](#)
[12059473](#) [12066261](#) [12110546](#) [12110546-B](#)