



1164-1255, 1559-1610 MHz GNSS ANTENNA

Part Number: 2108844-1

FEATURES & BENEFITS

- L1+G1 & L2+L5+E5b+G2 bands for GNSS
- Dual Port Patch Antenna
- Through-hole assembly
- The following data is based on Dia.150mm ground size

SPECIFICATIONS

Frequency Range (MHz)	1164 - 1255	1559 - 1610
VSWR	< 1.3:1	< 1.4:1
Peak Gain at Zenith	Typ. 5.4 dBic	Typ. 6.0 dBic
Axial ratio at Zenith	Typ. 1.4 dB	Typ. 1.3 dB
Average Gain	-5.4dBic	-2.6 dBic
Isolation	-24 dB	-21dB
LNA (Voltage & Current)	N/A	
Feed Point Impedance	50 ohms	
Polarization	RHCP	
Size	41.0 mm x 41.0 mm x 13.0 mm	
Weight	< 62.7 g	
Mounting	Adhesive Tape	
Mating Connector	N/A	
Cable	N/A	
Operating Temperature	-40 to +85°C	
Storage Temperature	-40 to +85°C	
Hazardous Materials	A certificate of conformance is available from the product page on TE website.	

1164-1255, 1559-1610 MHz GNSS ANTENNA

Standard Antenna Solutions

RF DATA

VSWR

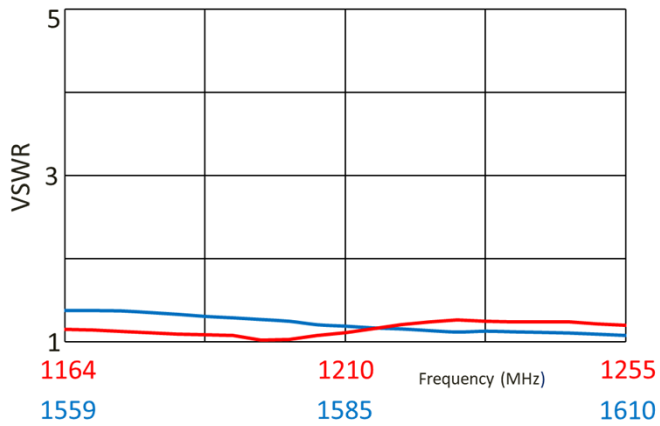

Return Loss

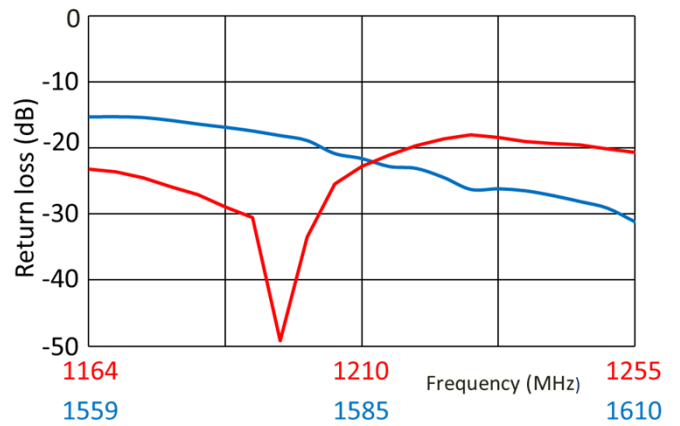

Peak Gain

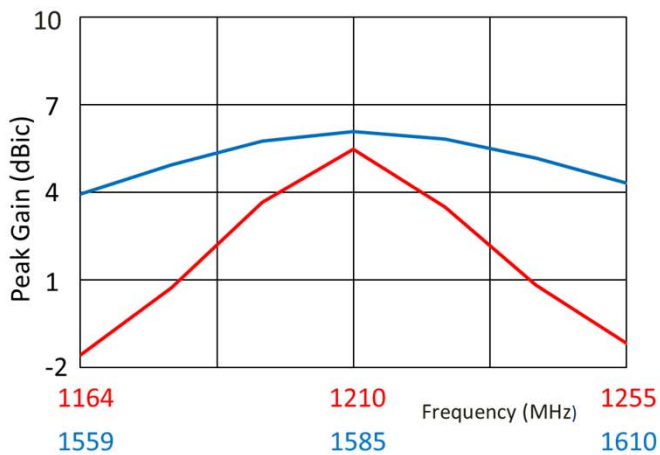

Isolation

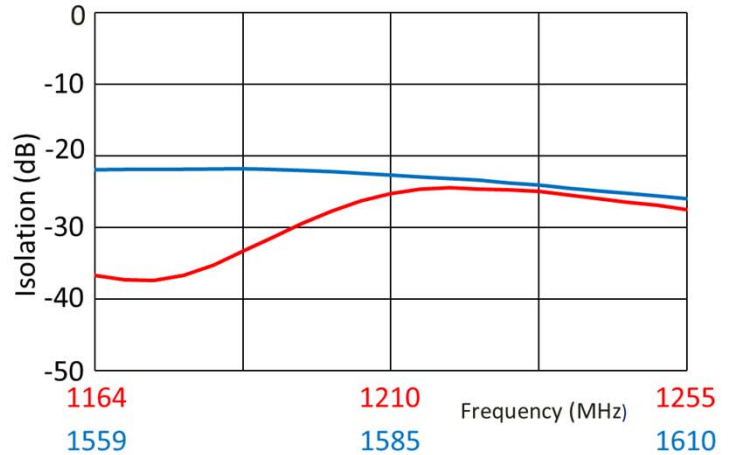

RADIATION PATTERN

Test setup

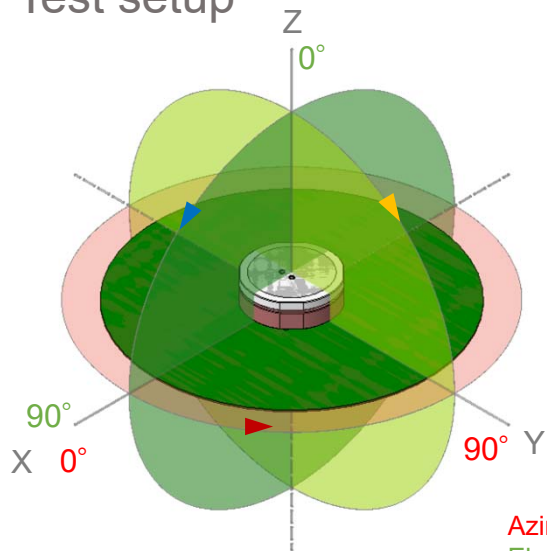

Azimuth Plane
Elevation 1 Plane
Elevation 2 Plane

Azimuth

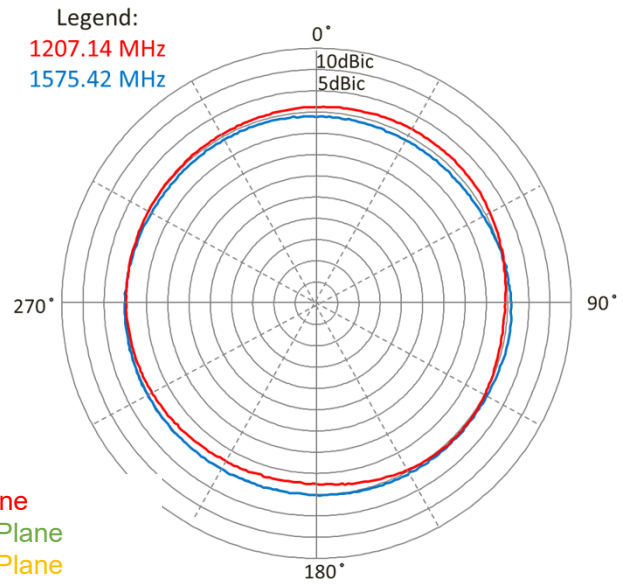

Elevation 1

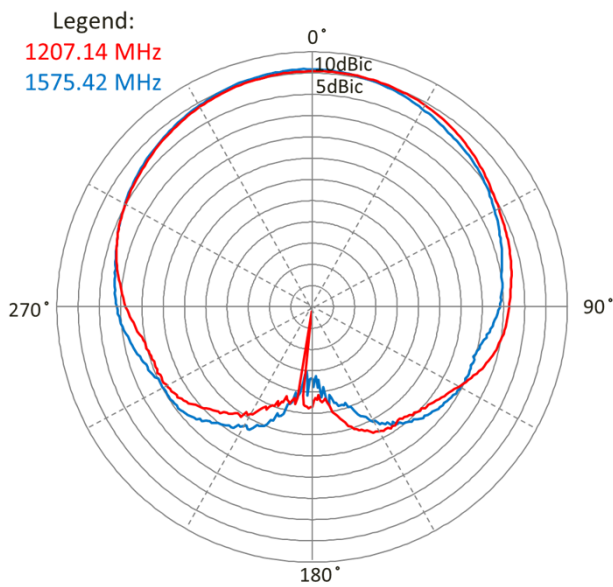

Elevation 2

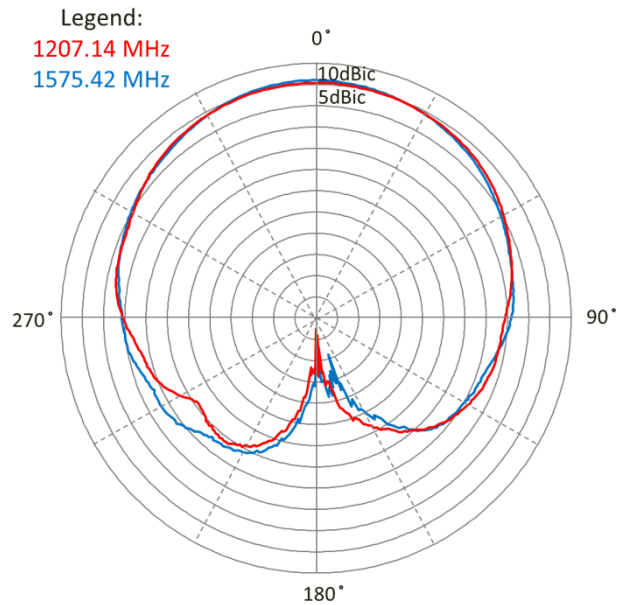

MOUNTING GUIDE

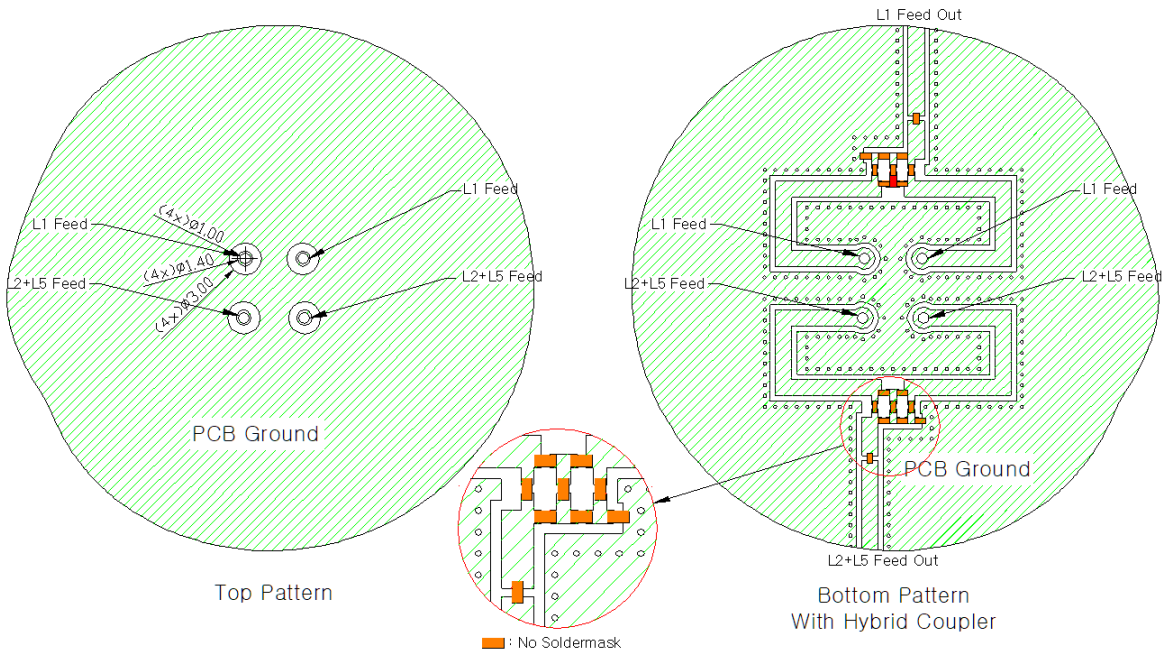

NOTES: 1. Suggested matching component pads
2. Please contact us for more information

Dimension: mm
Diagrams is not to scale

DIMENSIONS

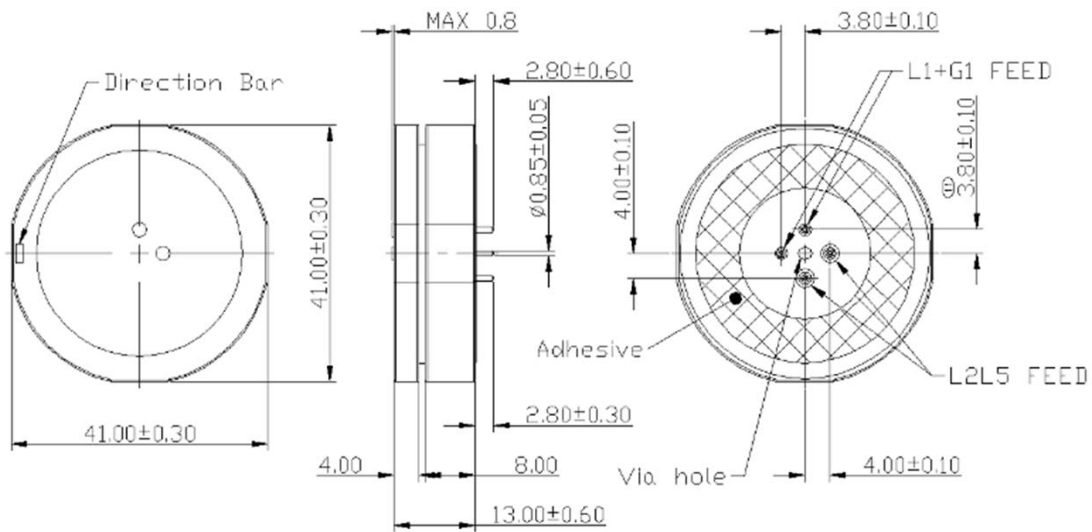

Dimension: mm
Diagrams is not to scale

1164-1255, 1559-1610 MHz GNSS ANTENNA

Standard Antenna Solutions

PACKAGING

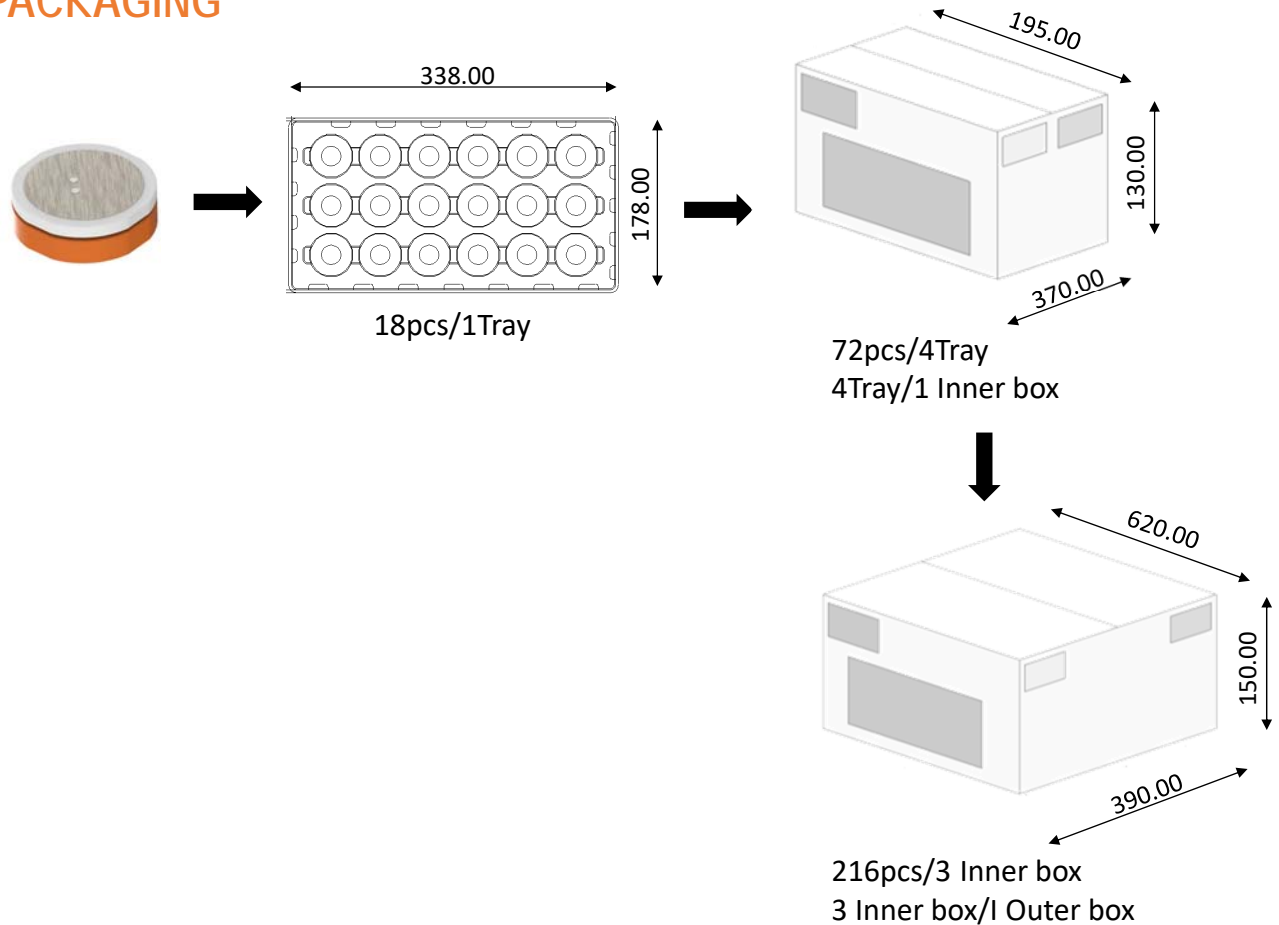

TE TECHNICAL SUPPORT CENTER

USA:	+1 (800) 522-6752
Canada:	+1 (905) 475-6222
Mexico:	+52 (0) 55-1106-0800
Latin/S. America:	+54 (0) 11-4733-2200
Germany:	+49 (0) 6251-133-1999
UK:	+44 (0) 800-267666
France:	+33 (0) 1-3420-8686
Netherlands:	+31 (0) 73-6246-999
China:	+86 (0) 400-820-6015

For phone numbers in other countries, go to te.com/support-center

te.com

TE Connectivity, TE Connectivity (logo) are trademarks. All other logos, products and/or company names referred to herein might be trademarks of their respective owners.

The information given herein, including drawings, illustrations and schematics which are intended for illustration purposes only, is believed to be reliable. However, TE Connectivity makes no warranties as to its accuracy or completeness and disclaims any liability in connection with its use. TE Connectivity's obligations shall only be as set forth in TE Connectivity's Standard Terms and Conditions of Sale for this product and in no case will TE Connectivity be liable for any incidental, indirect or consequential damages arising out of the sale, resale, use or misuse of the product. Users of TE Connectivity products should make their own evaluation to determine the suitability of each such product for the specific application.

© 2020 TE Connectivity Ltd. family of companies All Rights Reserved.

05/2021

X-ON Electronics

Largest Supplier of Electrical and Electronic Components

Click to view similar products for [Antennas](#) category:

Click to view products by [TE Connectivity](#) manufacturer:

Other Similar products are found below :

[GAN30084EU](#) [930-033-R](#) [GW17.07.0250E](#) [1513563-1](#) [EXE902SM](#) [APAMPG-117](#) [MAF94383](#) [W3908B0100](#) [W6102B0100](#) [YE572113-30RSMM](#) [108-00014-50](#) [66089-2406](#) [SPDA17RP918](#) [W3006VP](#) [A09-F8NF-M](#) [A09-F5NF-M](#) [RGFRA1903041A1T](#) [W3593B0100](#) [W3921B0100](#) [SIMNA-868](#) [SIMNA-915](#) [SIMNA-433](#) [W1044](#) [W1049B090](#) [A75-001](#) [WTL2449CQ1-FRSMM](#) [CPL9C](#) [EXB148BN](#) [0600-00060](#) [TRA9020S3PBN-001](#) [Y4503](#) [GD5W-28P-NF](#) [MA9-7N](#) [GD53-25](#) [GD5W-21P-NF](#) [C37](#) [MAF94051](#) [MA9-5N](#) [EXD420PL](#) [B1322NR](#) [QWFTB120](#) [MAF94271](#) [MAF94300](#) [GPSMB301](#) [FG4403](#) [AO-AGSM-OM54](#) [5200232](#) [MIKROE-2349](#) [WCM.01.0111](#) [MIKROE-2393](#)