

THIS DRAWING IS UNPUBLISHED. RELEASED FOR PUBLICATION
 © COPYRIGHT - By - ALL RIGHTS RESERVED.

LOC	DIST	REVISIONS			
P	LTR	DESCRIPTION	DATE	DWN	APVD
FT	0				
	G2	REVISED PER ECO-13-014760	19SEP13	KH	MM

MATERIAL:
 HOUSING: THERMOPLASTIC, UL94V-0, BLACK.
 TERMINALS: BRIGHT TIN OVER COPPER ALLOY.
 SCREWS: #6-32 STEEL, ZINC PLATING W/ CLEAR CHROMATE, EXCEPT WHERE NOTED OTHERWISE.

ELECTRICAL:
 RATED CURRENT UL/CSA:
 CLASS C: 20A, 300V.
 CLASS D: 5A, 600V.
 WIRE RANGE: 12-22 AWG

MECHANICAL:
 RECOMMENDED TORQUE: 7 IN-LB.
 OPERATING TEMP.: 105°C MAX.

- ① SCREWS BOTTOMED.
- ② NO SCREWS.
- ③ SCREWS ARE NICKEL PLATED BRASS.
- ④ PRELIMINARY

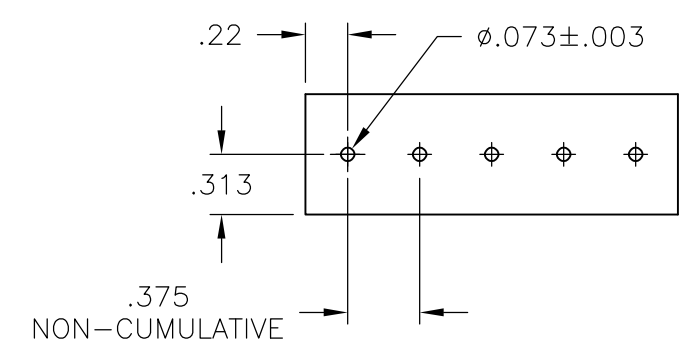
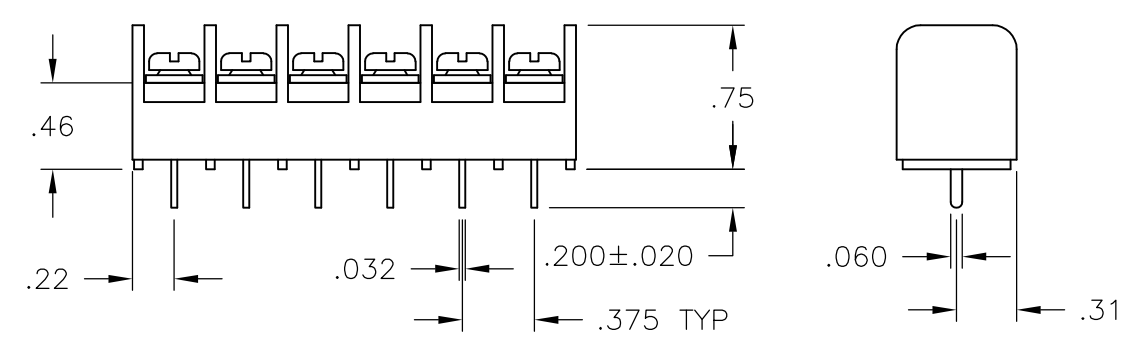
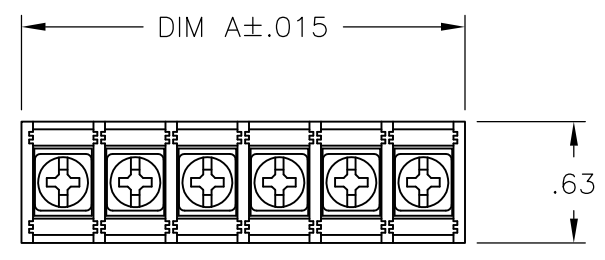

RECOMMENDED PCB LAYOUT

DIM. "A"	NO. OF POS.	CATALOG PART NO.	PART NO.
7.186	19	JC6-P108-19	4-796985-6
6.811	18	JC6-P108-18	4-796985-5
6.436	17	JC6-P108-17	5-1437666-7
6.061	16	JC6-P108-16	3-1437665-2
5.686	15	JC6-P108-15	4-796985-4
5.311	14	JC6-P108-14	3-1437665-1
4.936	13	JC6-P108-13	4-796985-3
③ 4.561	12	JC6-P106-12	1776249-8
4.561	12	JC6-P108-12	3-1437665-0
① 4.186	11	JC6-P108-11	2-1437665-9
3.811	10	JC6-P108-10	2-1437665-8
③ 3.436	9	JC6-P106-09	1776249-7
3.436	9	JC6-P108-09	796985-3
③ 3.061	8	JC6-P106-08	1776249-3
3.061	8	JC6-P108-08	2-1437665-7
③ 2.686	7	JC6-P106-07	1776249-2
2.686	7	JC6-P108-07	4-796985-2
③ 2.311	6	JC6-P106-06	1776249-6
① 2.311	6	JC6-P108-06-169	1-796985-4
2.311	6	JC6-P108-06	2-1437665-5
③ 1.936	5	JC6-P106-05	1776249-1
② 1.936	5	JC6-P108-05-161	2-1437665-4
1.936	5	JC6-P108-05	2-1437665-3
SEE FIGURE ① 1.561	4	JC6-P108-04-230	1-1776249-0
③ 1.561	4	JC6-P106-04	1776249-5
② 1.561	4	JC6-P108-04-186	796985-8
① 1.561	4	JC6-P108-04-167	1-796985-2
1.561	4	JC6-P108-04	2-1437665-2
SEE FIGURE ① 1.186	3	JC6-P108-03-229	1776249-9
③ 1.186	3	JC6-P106-03	1776249-4
1.186	3	JC6-P108-03	2-1437665-1
② .811	2	JC6-P108-02-161	1-1776249-1
.811	2	JC6-P108-02	2-1437665-0

THIS DRAWING IS A CONTROLLED DOCUMENT.		DWN S SCHLEGEL 18JUN02	TE Connectivity	
DIMENSIONS: INCHES		CHK S. YODER 6/18/02		
TOLERANCES UNLESS OTHERWISE SPECIFIED:		APVD S. YODER 6/18/02	NAME	
0 PLC ± - 1 PLC ± - 2 PLC ± .01 3 PLC ± .005 4 PLC ± - ANGLES ± -		PRODUCT SPEC -	JC6-P108-106-XX ASSEMBLY	
MATERIAL -		APPLICATION SPEC -	SIZE A3	CAGE CODE 00779
FINISH -		WEIGHT -	DRAWING NO C-2-1437665-0	RESTRICTED TO -
CUSTOMER DRAWING			SCALE NTS	SHEET 1 OF 2
			REV G2	

THIS DRAWING IS UNPUBLISHED. RELEASED FOR PUBLICATION
 © COPYRIGHT - By - ALL RIGHTS RESERVED.

LOC	DIST	REVISIONS					
FT	0	P	LTR	DESCRIPTION	DATE	DWN	APVD
		-		SEE SHEET 1	-	-	-

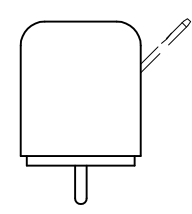
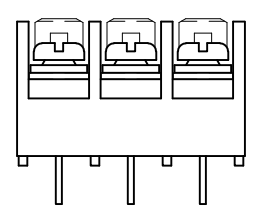
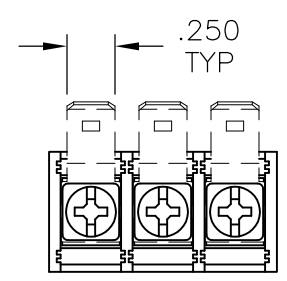

1776249-9

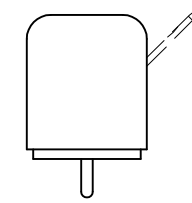
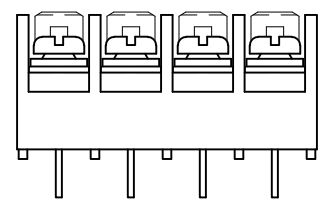
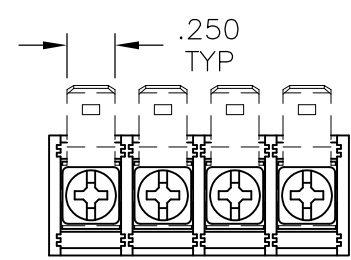

1-1776249-0

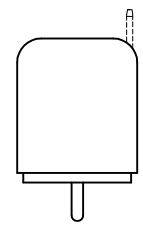
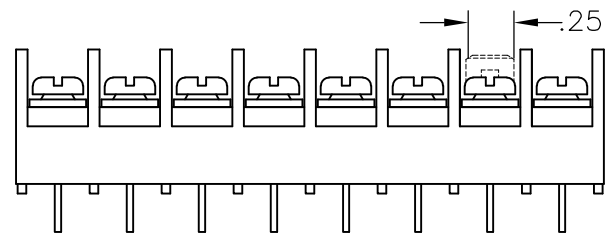
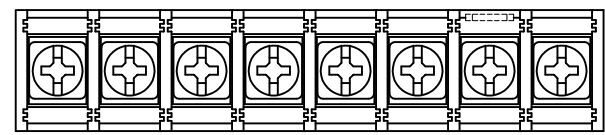

9-796985-9

4	3.061	8	JC6-P108-08-231	9-796985-9
	9.436	25	JC6-P108-25	5-796985-1
	9.061	24	JC6-P108-24	5-796985-0
OBSOLETE	8.686	23	JC6-P108-23	4-796985-9
OBSOLETE	8.311	22	JC6-P108-22	4-796985-8
	7.936	21	JC6-P108-21	1-796985-6
OBSOLETE	7.561	20	JC6-P108-20	4-796985-7

DIM. "A"	NO. OF POS.	CATALOG PART NO.	PART NO.
----------	-------------	------------------	----------

THIS DRAWING IS A CONTROLLED DOCUMENT.

DIMENSIONS: INCHES	TOLERANCES UNLESS OTHERWISE SPECIFIED:
	0 PLC ± -
	1 PLC ± -
	2 PLC ± .01
	3 PLC ± .005
	4 PLC ± -
	ANGLES ± -

MATERIAL - FINISH -

DWN	S SCHLEGEL	18JUN02
CHK	S. YODER	6/18/02
APVD	S. YODER	6/18/02

PRODUCT SPEC	-
APPLICATION SPEC	-
WEIGHT	-



JC6-P108/106-XX ASSEMBLY

SIZE	CAGE CODE	DRAWING NO	RESTRICTED TO
A3	00779	C-2-1437665-0	-

CUSTOMER DRAWING SCALE NTS SHEET 2 OF 2 REV G2

X-ON Electronics

Largest Supplier of Electrical and Electronic Components

Click to view similar products for [Barrier Terminal Blocks](#) category:

Click to view products by [TE Connectivity](#) manufacturer:

Other Similar products are found below :

[6C1N03](#) [6PCR-02-008](#) [6PCR-05-008](#) [6PCR-08-008](#) [6PCR-21-006](#) [6PCV-06-008](#) [6PCV-10-009](#) [6PCV-15-008](#) [6STR-06-006](#) [6STR-08-006](#)
[6STR-12-008](#) [6STR-14-008](#) [6STR-16-008](#) [6STR-17-008](#) [6STR-21-008](#) [6STR-25-008](#) [6STR-27-008](#) [6STV-03-006](#) [6STV-03-008](#) [6STV-04-006](#) [6STV-10-006](#) [6WWR-03](#) [6WWV-12-008](#) [6WWV-16-008](#) [7-1546701-0](#) [72212603](#) [72503-C](#) [72504-C-50](#) [73203](#) [76007](#) [7604-501LF](#)
[77010-50](#) [796985-3](#) [796988-4](#) [7C1N08](#) [8-1437402-5](#) [8-1437402-7](#) [8-1546158-0](#) [870505](#) [870903](#) [8PCR-06-006](#) [8PCV-02-008](#) [8PCV-05-008](#)
[8PCV-09-006](#) [8PCV-15-006](#) [8PCV-17-006](#) [8QCR-03-008](#) [8STV-04-006](#) [9-1437402-3](#) [A103104](#)