

THIS DRAWING IS UNPUBLISHED. RELEASED FOR PUBLICATION 20
 © COPYRIGHT 20 BY - ALL RIGHTS RESERVED.

REVISIONS					
P	LTR	DESCRIPTION	DATE	DWN	APVD
B1		REVISED PER ECR-16-011494	20JUN2017	NK	CX
B2		ECO-19-006934	13MAY2019	AP	WS
C		REVISED PER ECN-20-100924	15DEC2020	WLS	VS

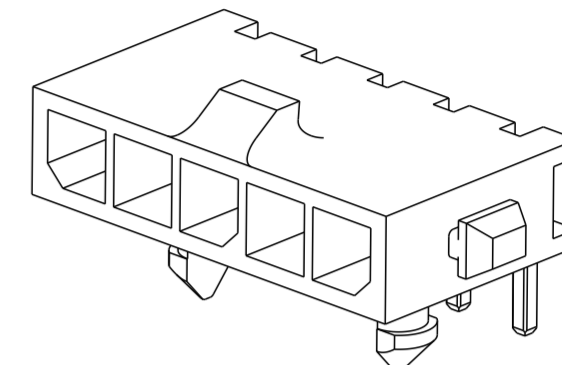

- 1 MATERIAL: HOUSING - UL 94V-O RATED HIGH TEMP., NYLON, COLOR BLACK. CONTACTS - BRASS
- 2 RECOMMENDED PC BOARD THICKNESS OF 1.57.
- 3 PLATING: CONTACTS - 2.54µm MINIMUM MATTE TIN OVER 1.27µm MINIMUM NICKEL.
- 4 COUNTERPART RECOMENDED IS PN 1445022 (DASH ACCORDING TO NUMBER OF POSITION).
- 5 FOR REELING DIRECTIONAND PACKAGING TYPE, SEE SPECIFICATION 114-13000.

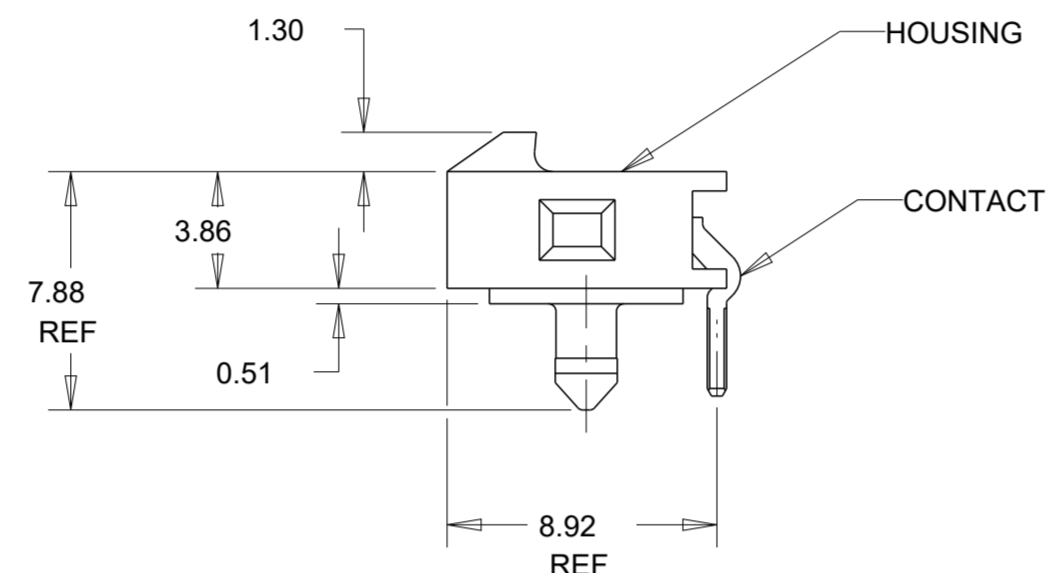
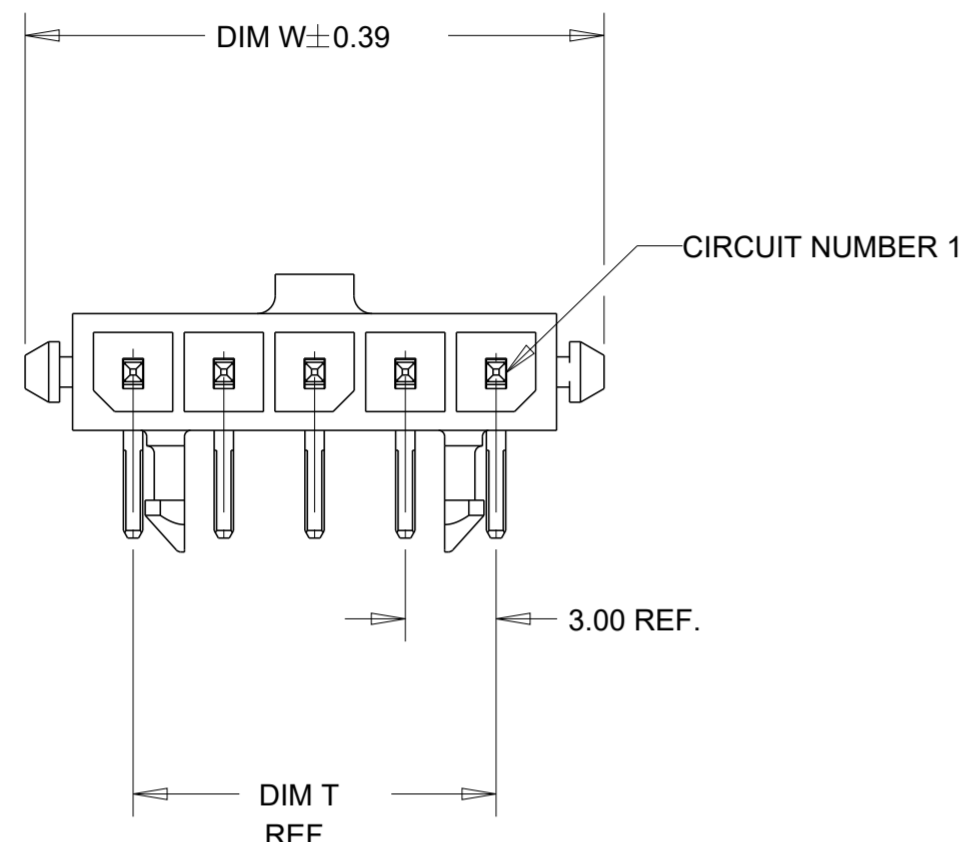
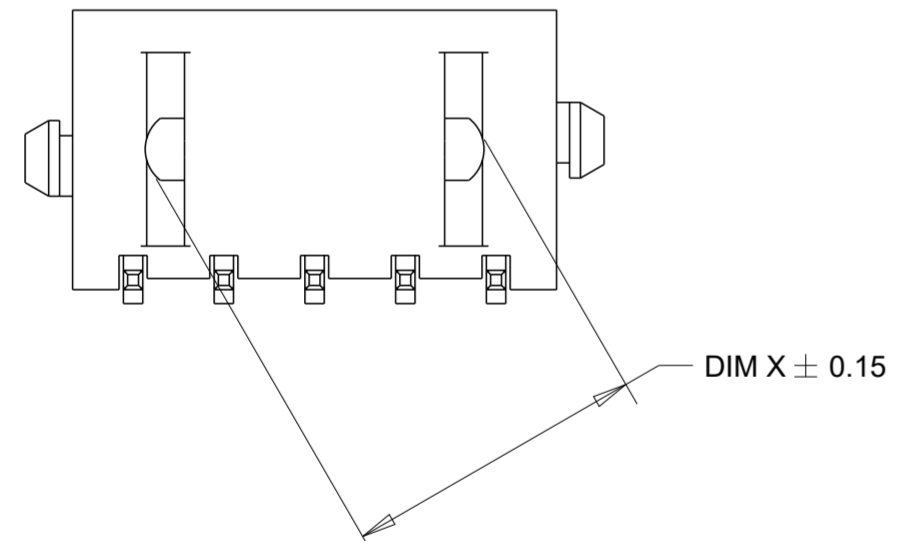

32.20	33.00	28.70	33.00	40.14	12	3-1445055-2
29.20	30.00	25.70	30.00	37.14	11	3-1445055-1
26.20	27.00	22.70	27.00	34.14	10	3-1445055-0
23.20	24.00	19.70	24.00	31.14	9	2-1445055-9
20.20	21.00	16.70	21.00	28.14	8	2-1445055-8
17.20	18.00	13.70	18.00	25.14	7	2-1445055-7
14.20	15.00	10.70	15.00	22.14	6	2-1445055-6
11.20	12.00	7.70	12.00	19.14	5	2-1445055-5
8.00	9.00	4.70	9.00	16.14	4	2-1445055-4
3.30	-	-	6.00	13.14	3	2-1445055-3
3.30	-	-	3.00	10.14	2	2-1445055-2
DIM X	DIM Z	DIM V	DIM T	DIM W	NO. OF POSN	PART NUMBER

THIS DRAWING IS A CONTROLLED DOCUMENT.		DWN J.ROOT 06OCT2000	TE Connectivity		
DIMENSIONS: mm		CHK K.WHITAKER 13-MAR-2001			
TOLERANCES UNLESS OTHERWISE SPECIFIED:		APVD K.WHITAKER 13-MAR-2001	NAME RIGHT ANGLE THRU HOLEHEADER ASSY, TIN CONTACTS W/PLASTIC HOLDDOWNS, SINGLE ROW, MICRO MATE-N-LOK TM		
0 PLC ± 1 PLC ± 2 PLC ±0.13 3 PLC ± 4 PLC ±		PRODUCT SPEC 108-1836	SIZE A2	CAGE CODE 00779	DRAWING NO 1445055
ANGLES ±1° FINISH		APPLICATION SPEC 114-13000	RESTRICTED TO -	SCALE 4:1	SHEET 1 OF 2
MATERIAL 1		WEIGHT -	CUSTOMER DRAWING		REV C
		3			

REVISIONS					
P	LTR	DESCRIPTION	DATE	DWN	APVD
-	-	SEE SHEET 1	-	-	-

2 POS.

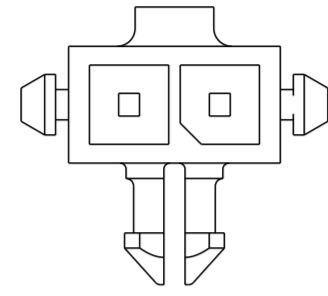

8 POS.

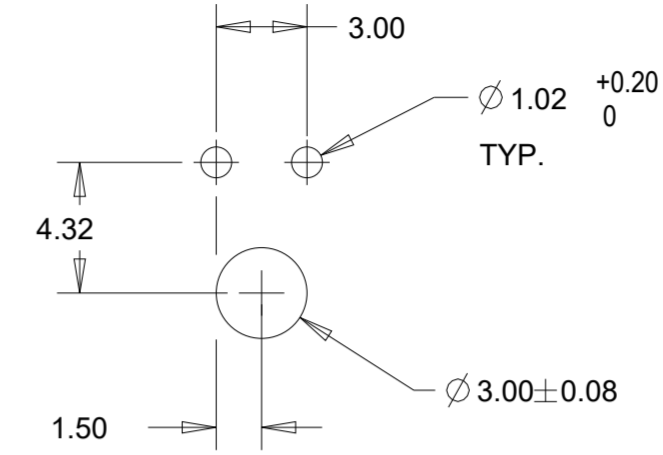
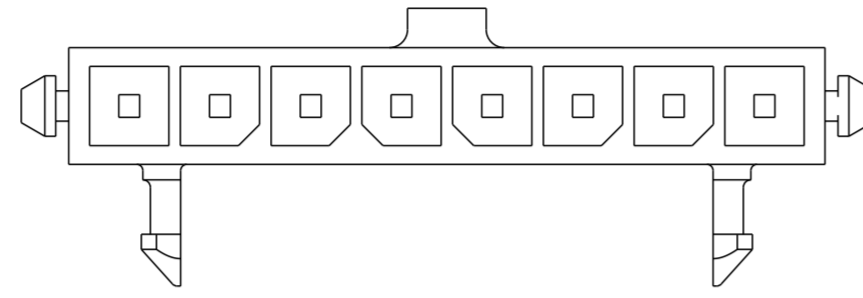

PCB LAYOUT FOR 2 POSITION COMPONENT SIDE

3 POS.

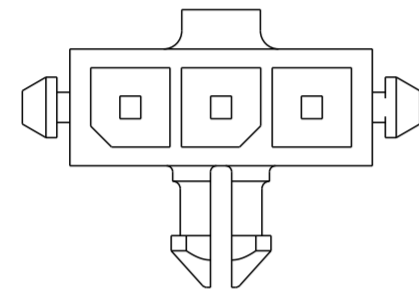

9 POS.

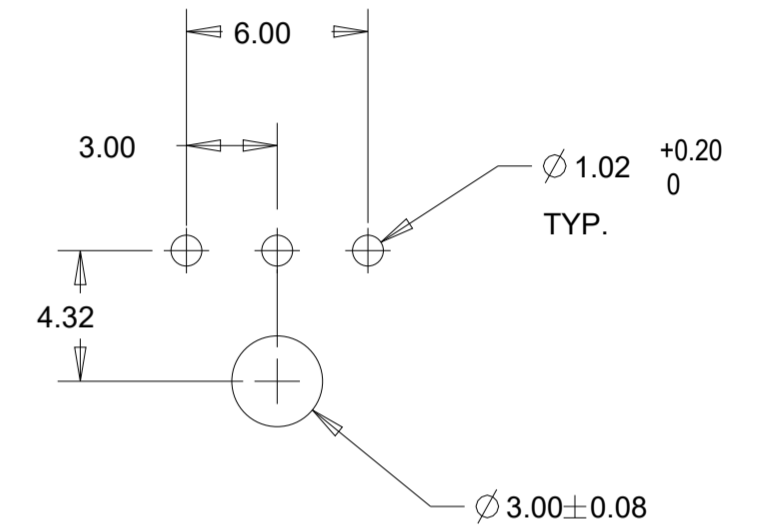
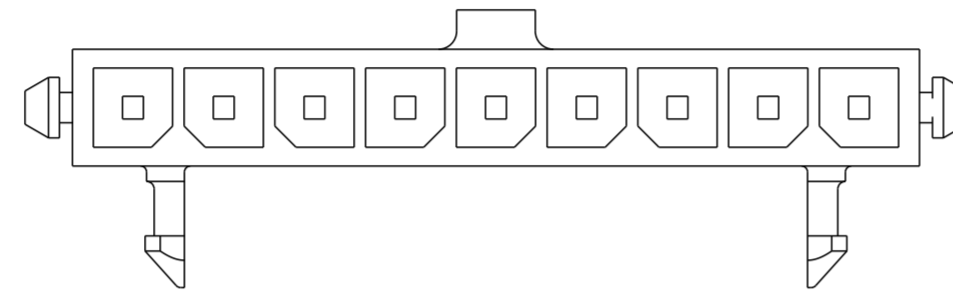

PCB LAYOUT FOR 3 POSITION COMPONENT SIDE

4 POS.

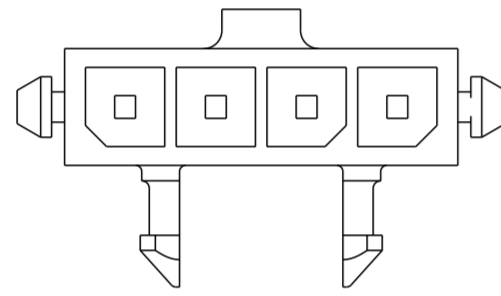

10 POS.

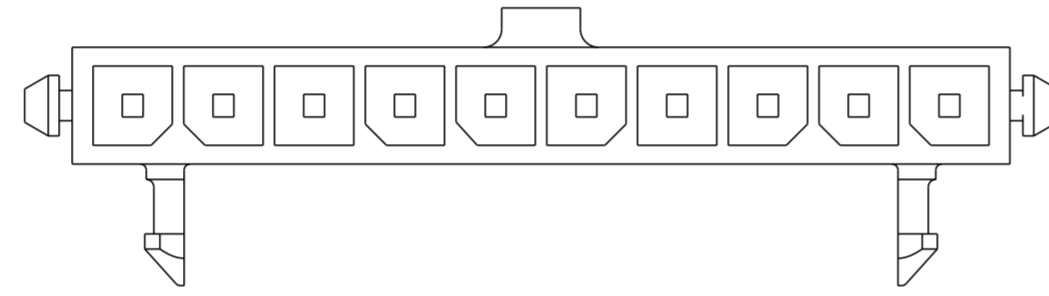

5 POS.

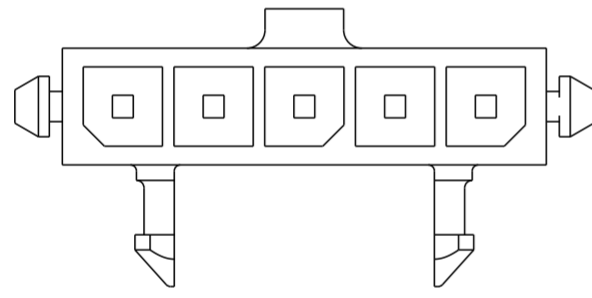

11 POS.

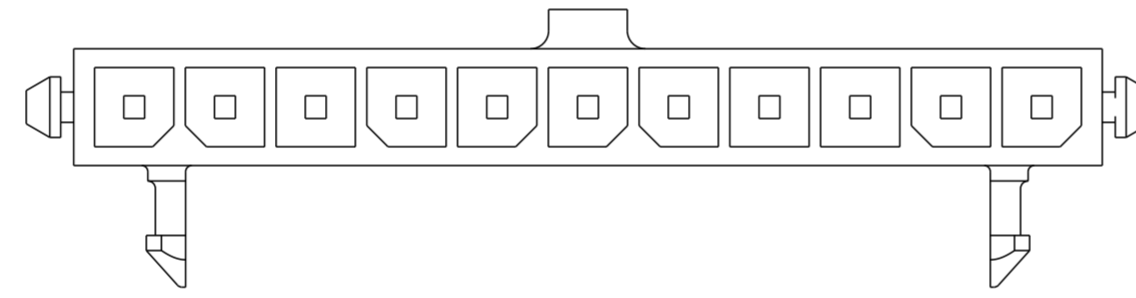

6 POS.

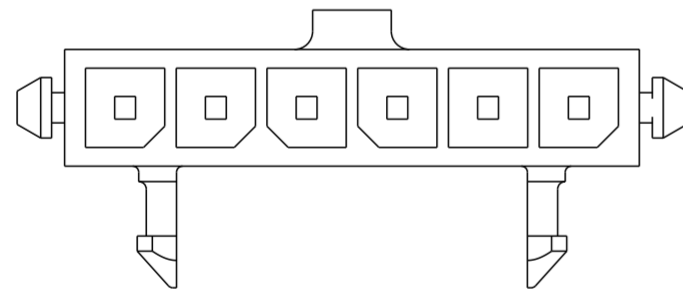

12 POS.

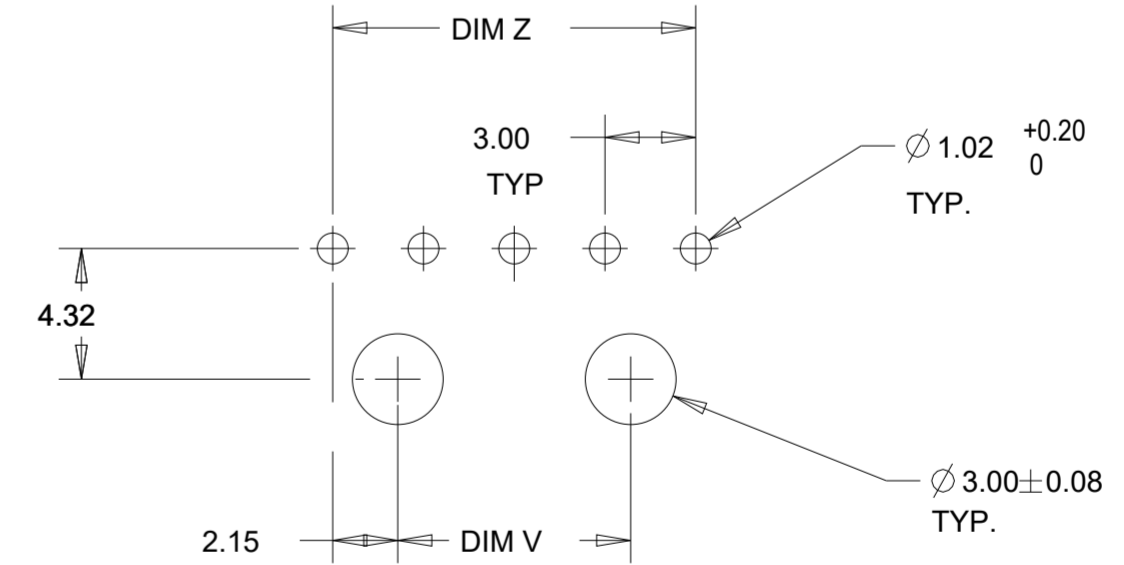
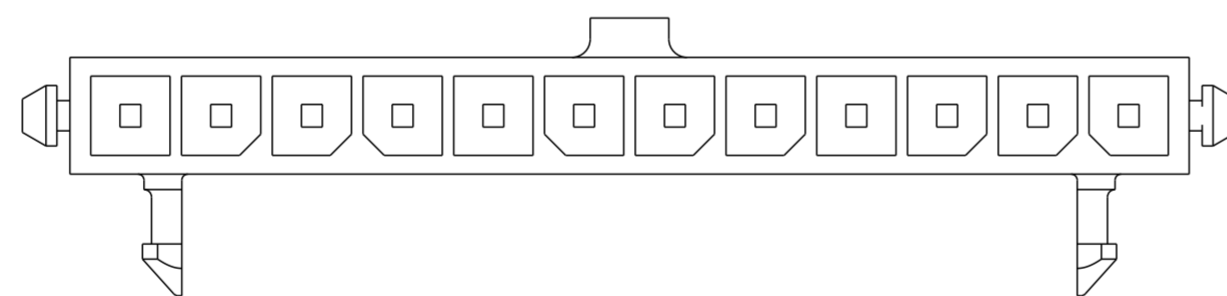

PCB LAYOUT FOR 4-12 POSITION COMPONENT SIDE

7 POS.

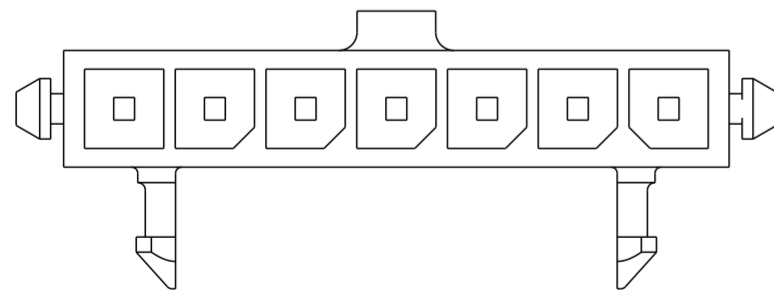

KEYING POSITION BI SIZE

THIS DRAWING IS A CONTROLLED DOCUMENT.		DWN J.ROOT 06OCT2000	TE Connectivity		
DIMENSIONS: mm		CHK K.WHITAKER 13-MAR-2001			
TOLERANCES UNLESS OTHERWISE SPECIFIED:		APVD K.WHITAKER 13-MAR-2001	NAME RIGHT ANGLE THRU HOLEHEADER ASSY, TIN CONTACTS W/PLASTIC HOLDDOWNS, SINGLE ROW, MICRO MATE-N-LOK TM		
0 PLC ± 1 PLC ± 2 PLC ±0.13 3 PLC ± 4 PLC ±		PRODUCT SPEC -	SIZE A2	CAGE CODE 00779	DRAWING NO. 1445055
ANGLES ±1° FINISH		APPLICATION SPEC -	RESTRICTED TO -	SCALE 5:1	SHEET 2 OF 2
MATERIAL -		WEIGHT -	CUSTOMER DRAWING	REV C	

X-ON Electronics

Largest Supplier of Electrical and Electronic Components

Click to view similar products for [Pin & Socket Connectors](#) category:

Click to view products by [TE Connectivity](#) manufacturer:

Other Similar products are found below :

[6450822-1](#) [770392-1](#) [794042-1](#) [796885-1](#) [8-794535-1](#) [PLR3455ACS-222](#) [R929991004](#) [R929993003](#) [1403611-1](#) [1-480349-5](#) [152302-5](#)
[153211-2](#) [1586092-1](#) [1586129-1](#) [1586681-4](#) [1586700-1](#) [1586368-1](#) [1586380-1](#) [1586616-1](#) [1586680-5](#) [16-06-0038](#) [164164-5](#) [1-6609930-1](#)
[172296-1](#) [19-09-2035](#) [200503-1](#) [200788-2](#) [2029090-4](#) [2029095-4](#) [925061-7](#) [293734-4](#) [293737-2](#) [1-765362-4](#) [1871534-1](#) [200833-4](#)
[2008625-2](#) [2029027-2](#) [2029096-4](#) [R929991000](#) [R929991002](#) [R929993000](#) [319-10-101-00-005000](#) [319-10-102-00-001000](#) [319-10-104-00-001000](#) [319-10-105-00-001000](#) [319-10-108-00-001000](#) [319-10-112-00-006000](#) [39-01-8019](#) [319-10-101-00-001000](#) [319-10-102-00-005000](#)