

THIS DRAWING IS UNPUBLISHED. RELEASED FOR PUBLICATION 2011  
 © COPYRIGHT 2011 ALL RIGHTS RESERVED.

LOC	DIST	REVISIONS					
CM	00	P	LTR	DESCRIPTION	DATE	DWN	APVD
		A2		REVISED PER ECR-16-011506	23JUN2017	NK	CX
		A3		ECO-19-006934	10MAY2019	AP	WLS
		B		REVISED PER ECN-20-100924	15DEC2020	WLS	VS

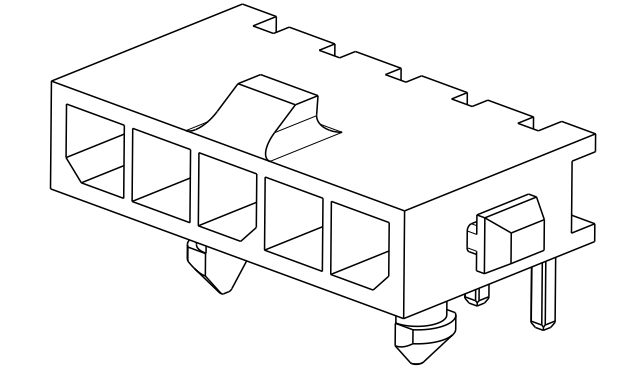

- 1 MATERIAL: HOUSING - UL 94V-0 RATED HIGH TEMP., NYLON, COLOR BLACK. CONTACTS - BRASS
  - 2 RECOMMENDED PC BOARD THICKNESS OF 1.57.
  - 3 PLATING: CONTACTS - 0.38µm MINIMUM GOLD ON MATING AREA. 2.54µm MINIMUM MATTE TIN ON SOLDER TAILS. ALL OVER 1.27µm MINIMUM NICKEL.
- 4 COUNTERPART RECOMENDED IS PN 1445022 9DASH ACCORDING TO NUMBER OF POSITION).
- 5 FOR REELING DIRECTION AND PACKAGING TYPE, SEE SPECIFICATION 114-13000.

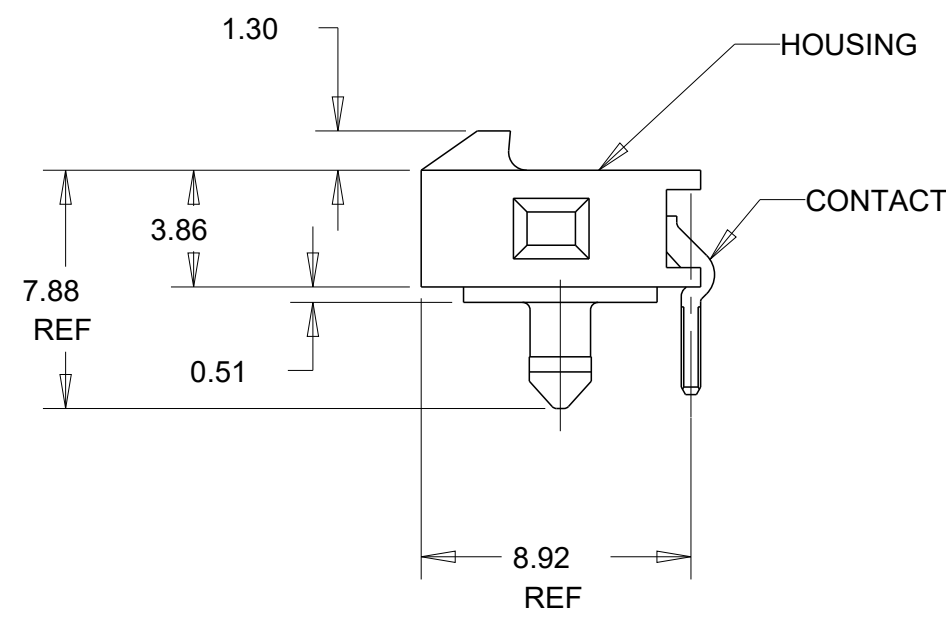
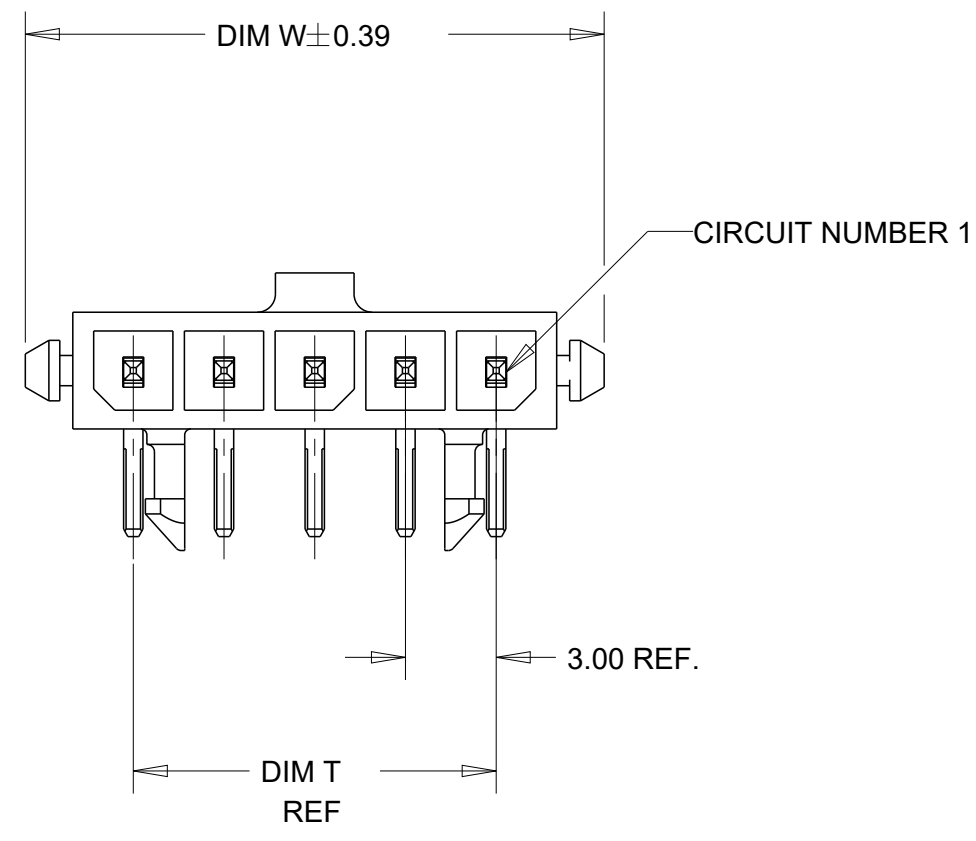
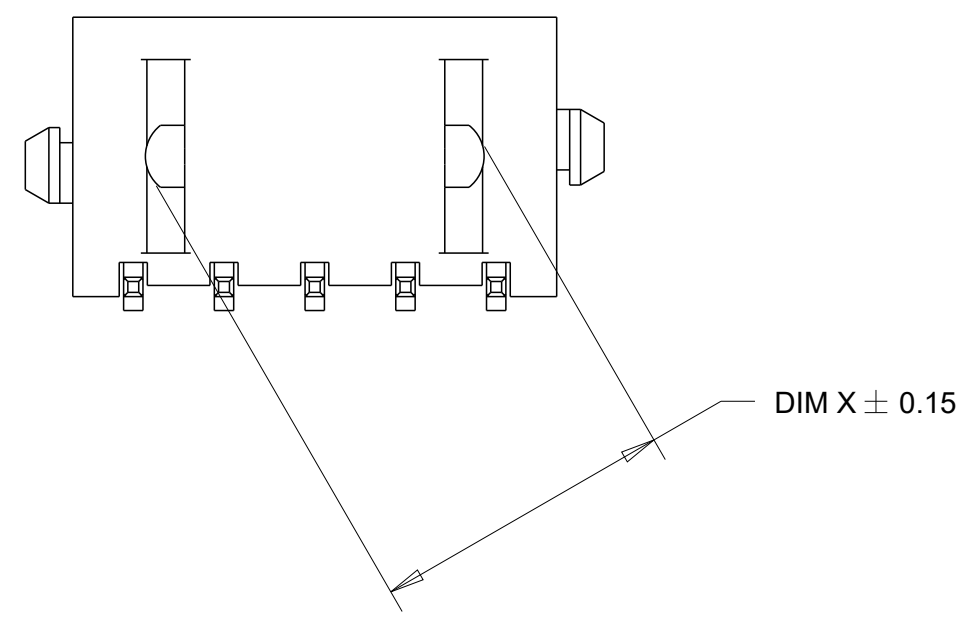

32.20	33.00	28.70	33.00	40.14	12	3-1445089-2
29.20	30.00	25.70	30.00	37.14	11	3-1445089-1
26.20	27.00	22.70	27.00	34.14	10	3-1445089-0
23.20	24.00	19.70	24.00	31.14	9	2-1445089-9
20.20	21.00	16.70	21.00	28.14	8	2-1445089-8
17.20	18.00	13.70	18.00	25.14	7	2-1445089-7
14.20	15.00	10.70	15.00	22.14	6	2-1445089-6
11.20	12.00	7.70	12.00	19.14	5	2-1445089-5
8.00	9.00	4.70	9.00	16.14	4	2-1445089-4
3.30	-	-	6.00	13.14	3	2-1445089-3
3.30	-	-	3.00	10.14	2	2-1445089-2
DIM X	DIM Z	DIM V	DIM T	DIM W	NO. OF POSN	PART NUMBER

THIS DRAWING IS A CONTROLLED DOCUMENT.		DWN J.ROOT 09OCT2000	TE Connectivity	
DIMENSIONS: mm		CHK K. WHITAKER 17-APR-2001		
TOLERANCES UNLESS OTHERWISE SPECIFIED:		APVD C. JONES 17-APR-2001	NAME RIGHT ANGLE THRU HOLE HEADER ASSY, 0.38 MIC GOLD CONTACTS, WITH PLASTIC HOLDDOWNS, SGL ROW, MICRO MATE-N-LOK TM	
0 PLC ±		PRODUCT SPEC 108-1836	SIZE A2	CAGE CODE 00779
1 PLC ±		APPLICATION SPEC 114-13000	DRAWING NO C-1445089	RESTRICTED TO -
2 PLC ±0.13		WEIGHT -	SCALE 4:1	SHEET 1 OF 2
3 PLC ±		MATERIAL -	REV B	
4 PLC ±				
ANGLES ±°				
FINISH				

LOC	DIST	REVISIONS			
P	LTR	DESCRIPTION	DATE	DWN	APVD
CM	00	SEE SHEET 1			

2 POS.

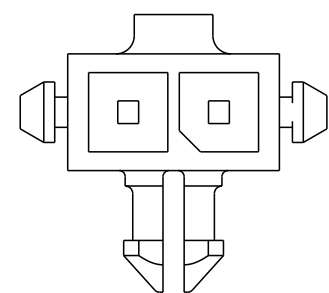

8 POS.

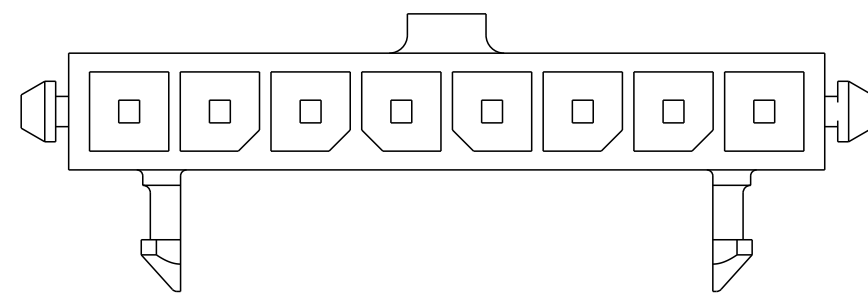

3 POS.

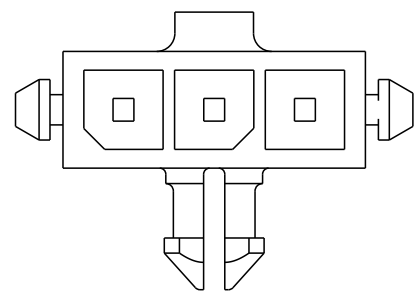

9 POS.

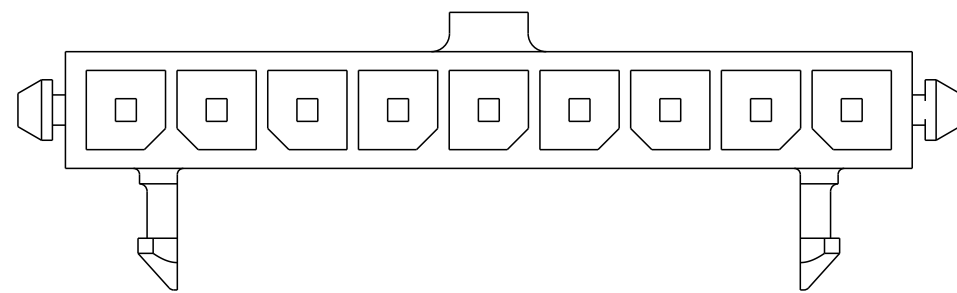

4 POS.

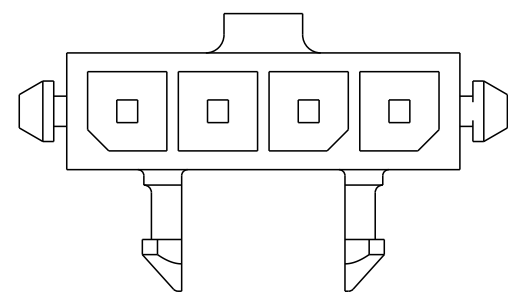

10 POS.

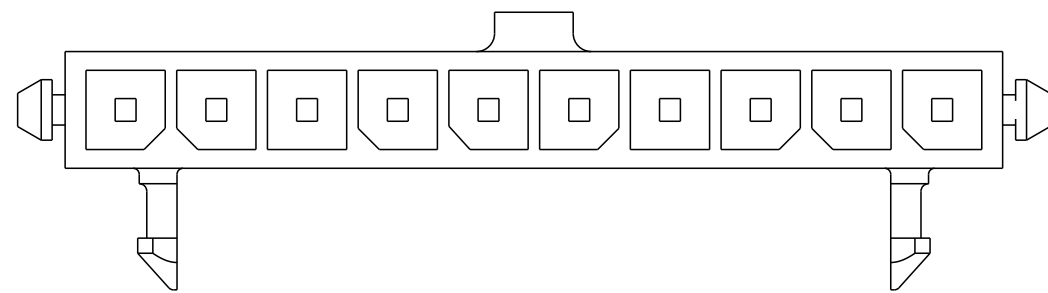

5 POS.

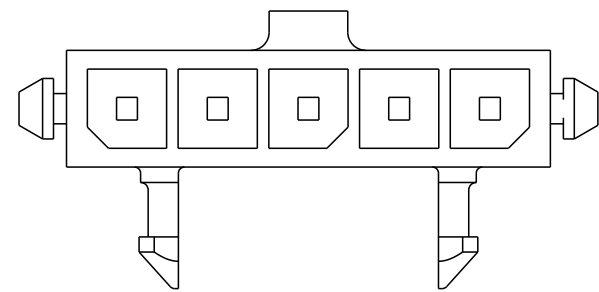

11 POS.

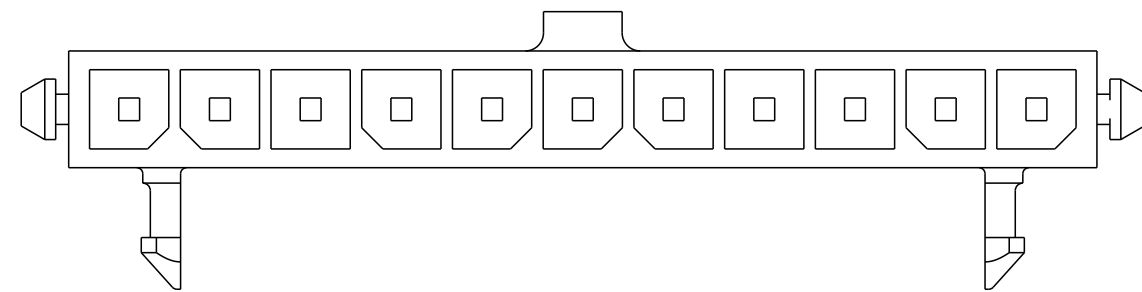

6 POS.

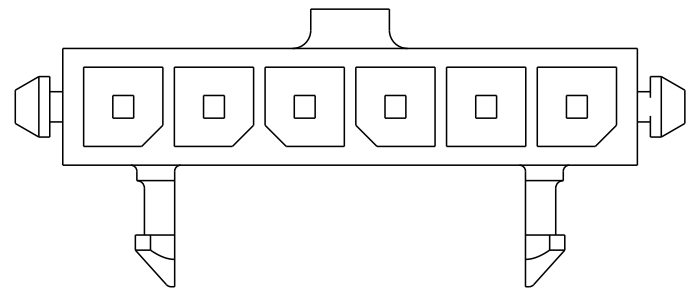

12 POS.

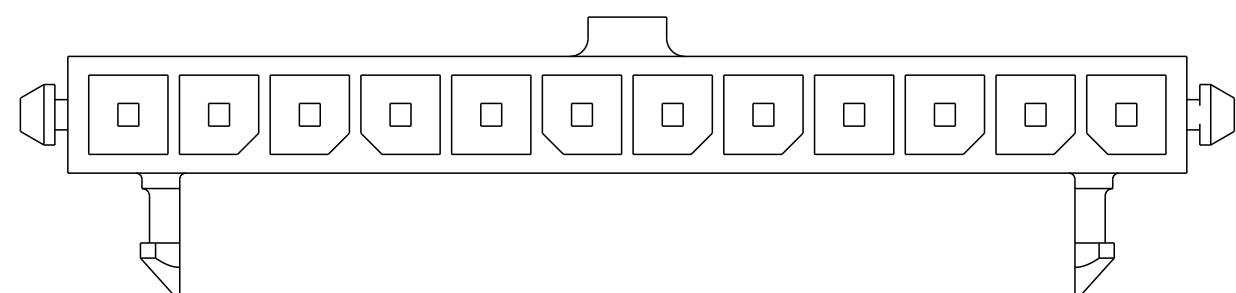

7 POS.

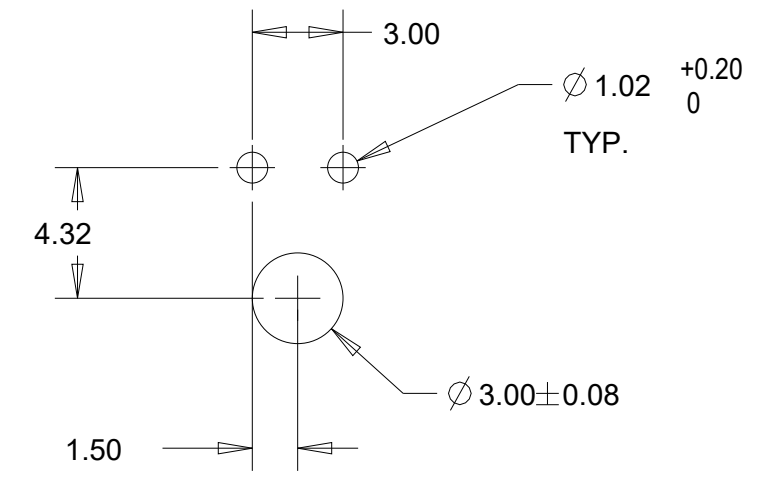
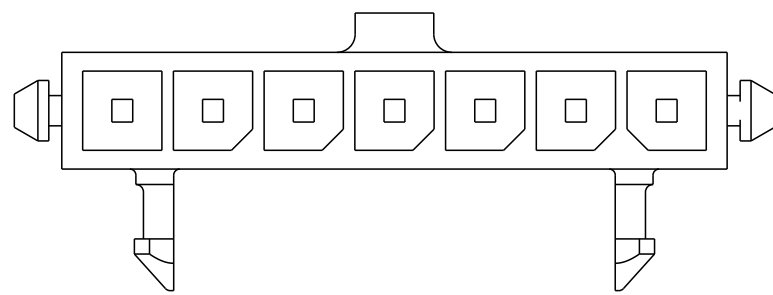

PCB LAYOUT FOR 2 POSITION COMPONENT SIDE

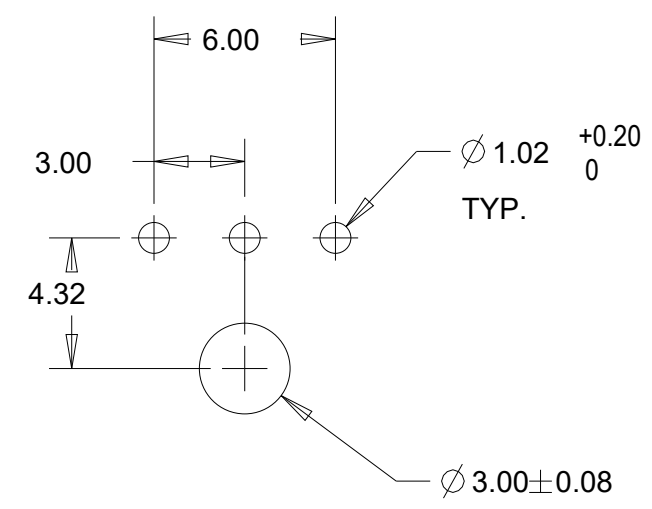

PCB LAYOUT FOR 3 POSITION COMPONENT SIDE

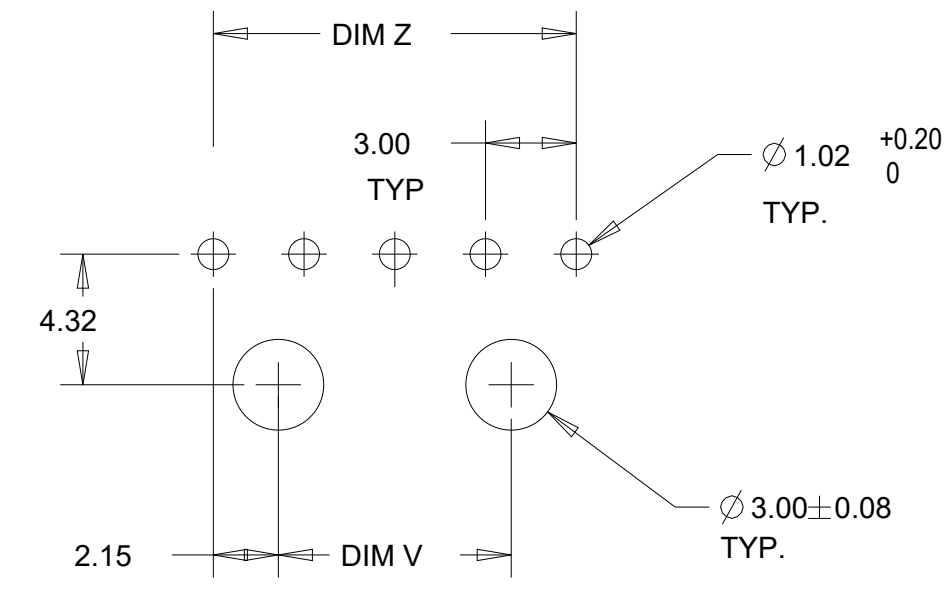

PCB LAYOUT FOR 4-12 POSITION COMPONENT SIDE



KEYING POSITION BI SIZE

THIS DRAWING IS A CONTROLLED DOCUMENT.		DWN J.ROOT 09OCT2000	TE Connectivity	
DIMENSIONS:		CHK K. WHITAKER 17-APR-2001		
mm	TOLERANCES UNLESS OTHERWISE SPECIFIED:	APVD C. JONES 17-APR-2001	NAME RIGHT ANGLE THRU HOLE HEADER ASSY, 0.38 MIC GOLD CONTACTS, WITH PLASTIC HOLDDOWNS, SGL ROW, MICRO MATE-N-LOK TM	
	0 PLC ±	PRODUCT SPEC	SIZE	RESTRICTED TO
	1 PLC ±	APPLICATION SPEC	A2	
	2 PLC ±0.13	WEIGHT	00779	
	3 PLC ±	CUSTOMER DRAWING	SCALE 5:1	
	4 PLC ±		SHEET 2 OF 2	
	ANGLES ±1°		REV B	
MATERIAL	FINISH			

## X-ON Electronics

Largest Supplier of Electrical and Electronic Components

*Click to view similar products for [Pin & Socket Connectors](#) category:*

*Click to view products by [TE Connectivity](#) manufacturer:*

Other Similar products are found below :

[6450822-1](#) [770392-1](#) [794042-1](#) [796885-1](#) [8-794535-1](#) [PLR3455ACS-222](#) [R929991004](#) [R929993003](#) [1403611-1](#) [1-480349-5](#) [152302-5](#)  
[153211-2](#) [1586092-1](#) [1586129-1](#) [1586681-4](#) [1586700-1](#) [1586368-1](#) [1586380-1](#) [1586616-1](#) [1586680-5](#) [16-06-0038](#) [164164-5](#) [1-6609930-1](#)  
[172296-1](#) [19-09-2035](#) [200503-1](#) [200788-2](#) [2029090-4](#) [2029095-4](#) [925061-7](#) [293734-4](#) [293737-2](#) [1-765362-4](#) [1871534-1](#) [200833-4](#)  
[2008625-2](#) [2029027-2](#) [2029096-4](#) [R929991000](#) [R929991002](#) [R929993000](#) [319-10-101-00-005000](#) [319-10-102-00-001000](#) [319-10-104-00-001000](#) [319-10-105-00-001000](#) [319-10-108-00-001000](#) [319-10-112-00-006000](#) [39-01-8019](#) [319-10-101-00-001000](#) [319-10-102-00-005000](#)