

THIS DRAWING IS UNPUBLISHED. RELEASED FOR PUBLICATION
 © COPYRIGHT - By - ALL RIGHTS RESERVED.

LOC	DIST	REVISIONS			
P	LTR	DESCRIPTION	DATE	DWN	APVD
-	-	SEE SHEET 1	-	-	-

PHYSICAL PROPERTIES:
 HOUSING MATERIAL: THERMOPLASTIC, PC
 FLAMMABILITY: UL94V-0 COLOR: BLACK
 MAX BOW/WARP: .0056 IN/IN.

TERMINAL:
 TERMINALS: BRASS, TIN PLATED
 SCREWS: 6-32, STEEL, NICKEL PLATED

MECHANICAL:
 PITCH (TERMINAL SPACING): 9.50mm(.374")
 WIRE RANGE: 12-22 AWG
 RECOMMENDED TIGHTENING TORQUE: 12IN-LBS MAX.

ELECTRICAL PROPERTIES:
 MAXIMUM CURRENT: 20A
 OPERATING VOLTAGE: 300V

ENVIRONMENTAL PROPERTIES:
 OPERATING TEMP RANGE: -40°C TO +120°C.

- ① SEE FIGURE.
- ② MARKED WITH WHITE INK.
- ③ PRELIMINARY PART NUMBER.
- ④ SCREWS AND TERMINALS ARE NICKEL PLATED BRASS.
- ⑤ STAINLESS STEEL SCREWS.
- ⑥ SCREWS ARE NICKEL PLATED BRASS.
- ⑦ WIRE CLAMP SCREWS TO BE USED ONLY ON SIDE OPPOSITE QC TABS.
- ⑧ TE CONNECTIVITY LOGO LOCATED APPROXIMATE AREA SHOWN.

-- SELECT LOAD CHART --

-	-	4-5,5-6	-	-	-	-	ALL	-	-	-	-	11	3-1546306-4
-	-	-	-	-	-	-	ALL	1-3	-	-	-	10	6-1546306-0
-	-	1,2	-	-	-	ALL	-	-	-	-	-	7	5-1546306-0
-	-	-	-	-	1	ALL	-	-	-	-	-	6	4-1546306-9
⑫ QC TAB .187 SS FLAT	⑪ QC TAB .187 SS 90°	⑩ JUMPER	⑨ QC TAB DBL SIDE 90° .250	⑧ QC TAB DBL SIDE 45° .250	⑦ QC TAB DBL SIDE FLAT .250	⑥ QC TAB DBL SIDE 90° .187	⑤ QC TAB DBL SIDE 45° .187	④ QC TAB DBL SIDE FLAT .187	③ QC TAB SGL SIDE 90° .250	② QC TAB SGL SIDE 45° .250	① QC TAB SGL SIDE FLAT .250	NO. OF POS.	PART NUMBER
POSITIONS LOADED													

-	-	-	-	-	-	-	-	-	-	-	-	-	-	294.7	302.2	30	3-1546306-0
-	-	-	-	-	-	-	-	-	-	-	-	-	-	285.2	292.7	29	2-1546306-9
-	-	-	-	-	-	-	-	-	-	-	-	-	-	275.7	283.2	28	2-1546306-8
-	-	-	-	-	-	-	-	-	-	-	-	-	-	266.2	273.7	27	2-1546306-7
-	-	-	-	-	-	-	-	-	-	-	-	-	-	256.7	264.2	26	2-1546306-6
-	-	-	-	-	-	-	-	-	-	-	-	-	-	247.2	254.7	25	2-1546306-5
-	-	-	-	-	-	-	-	-	-	-	-	-	-	237.7	245.2	24	2-1546306-4
-	-	-	-	-	-	-	-	-	-	-	-	-	-	228.2	235.7	23	2-1546306-3
-	-	-	-	-	-	-	-	-	-	-	-	-	-	218.7	226.2	22	2-1546306-2
-	-	-	-	-	-	-	-	-	-	-	-	-	-	209.2	216.7	21	2-1546306-1
④ SPL MARKING	-	-	-	-	-	-	-	-	-	-	-	-	-	199.7	207.2	20	3-1546306-2
-	-	-	-	-	-	-	-	-	-	-	-	-	-	199.7	207.2	20	2-1546306-0
-	-	-	-	-	-	-	-	-	-	-	-	-	-	190.2	197.7	19	1-1546306-9
NOTES	⑬ QC TAB .187 SS FLAT	⑫ QC TAB .187 SS FLAT	⑪ QC TAB .187 SS 90°	⑩ JUMPER	⑨ QC TAB DBL SIDE 90° .250	⑧ QC TAB DBL SIDE 45° .250	⑦ QC TAB DBL SIDE FLAT .250	⑥ QC TAB DBL SIDE 90° .187	⑤ QC TAB DBL SIDE 45° .187	④ QC TAB DBL SIDE FLAT .187	③ QC TAB SGL SIDE 90° .250	② QC TAB SGL SIDE 45° .250	① QC TAB SGL SIDE FLAT .250	DIM B	DIM A	NO. OF POS.	PART NO.

THIS DRAWING IS A CONTROLLED DOCUMENT.

DWN S SCHLEGEL	20AUG2002	STE TE Connectivity
CHK C RICHARD	8/20/02	
APVD C RICHARD	8/20/02	
PRODUCT SPEC		
APPLICATION SPEC		NAME 9.50MM (.374) DBL ROW BARRIER STRIP W/O WASHER
MATERIAL	FINISH	SIZE A2
WEIGHT		CAGE CODE 00779
CUSTOMER DRAWING		DRAWING NO 1546306
SCALE NTS		RESTRICTED TO -
SHEET 2 of 3		REV H2

THIS DRAWING IS UNPUBLISHED. RELEASED FOR PUBLICATION
 © COPYRIGHT - By - ALL RIGHTS RESERVED.

LOC		DIST		REVISIONS			
P	LTR	DESCRIPTION	DATE	DWN	APVD		
-	-	SEE SHEET 1	-	-	-	-	-

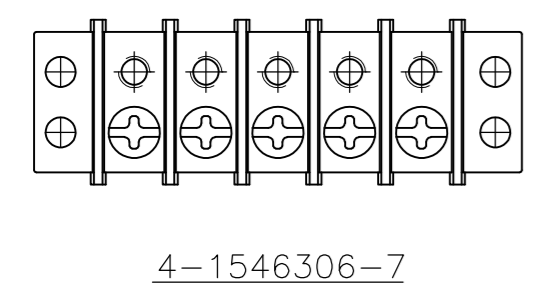
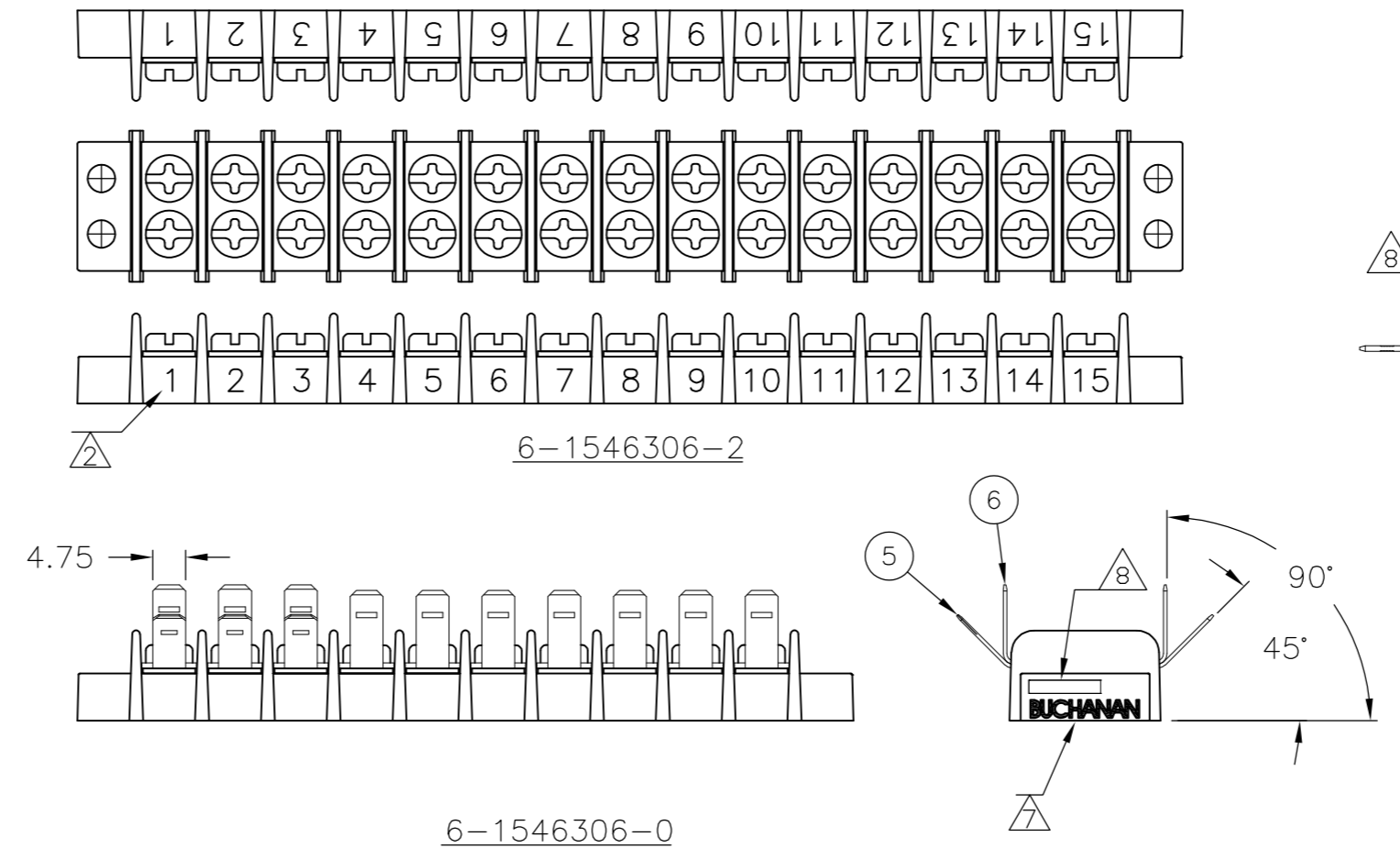
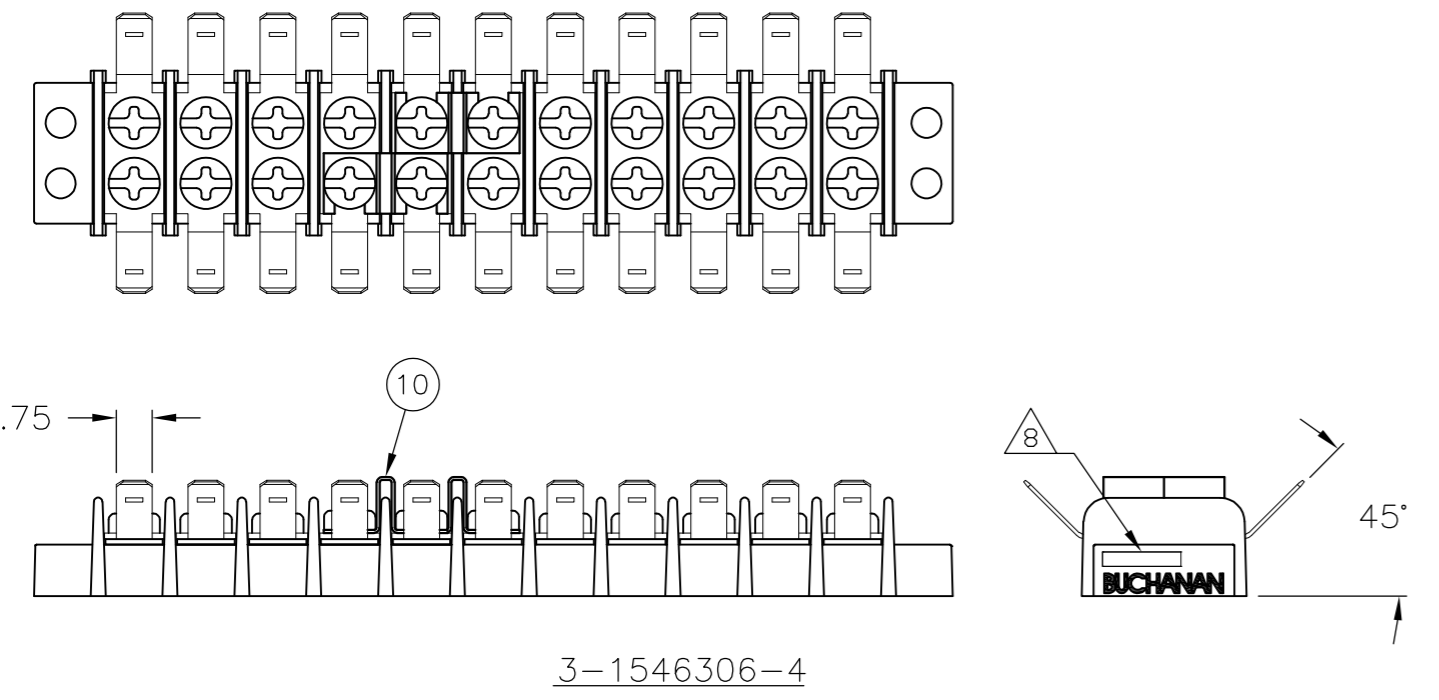
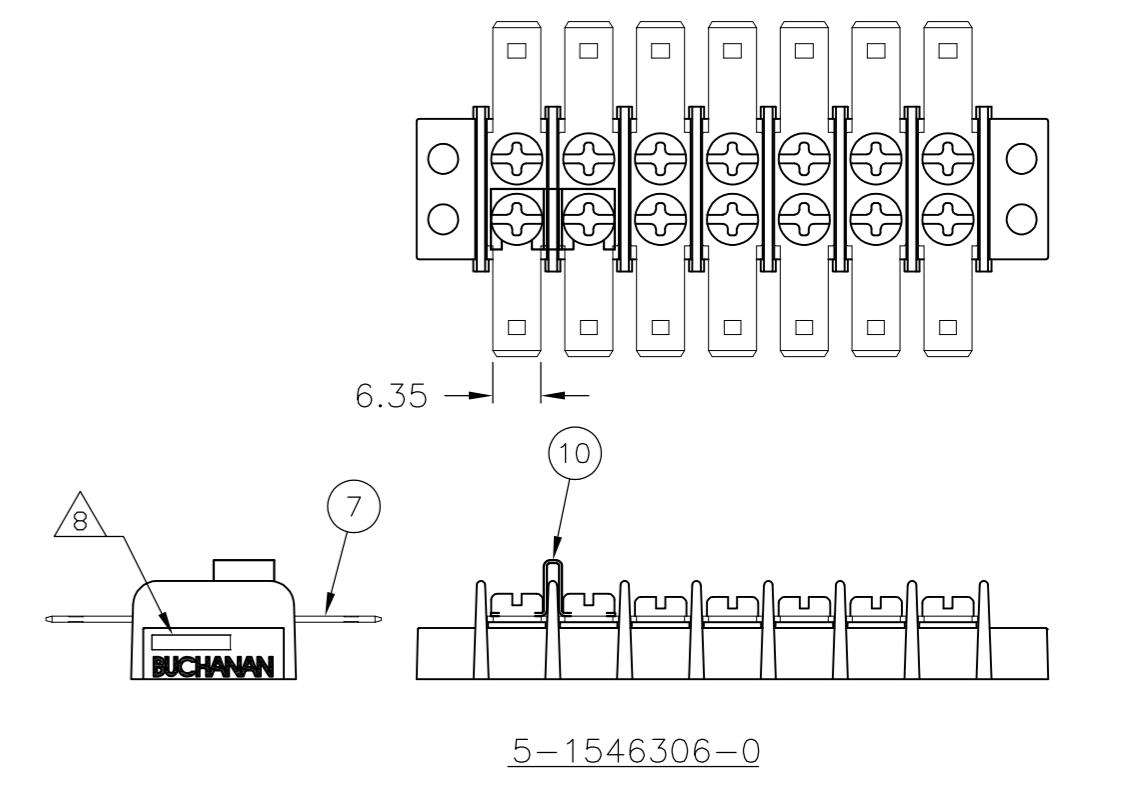
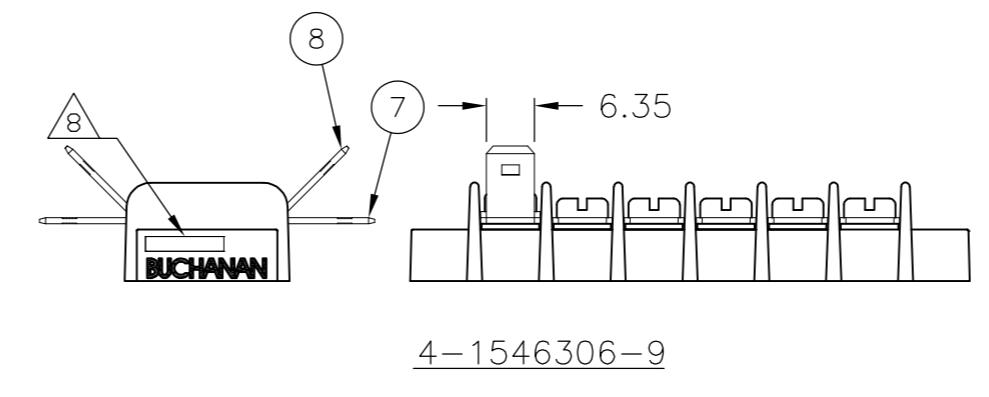
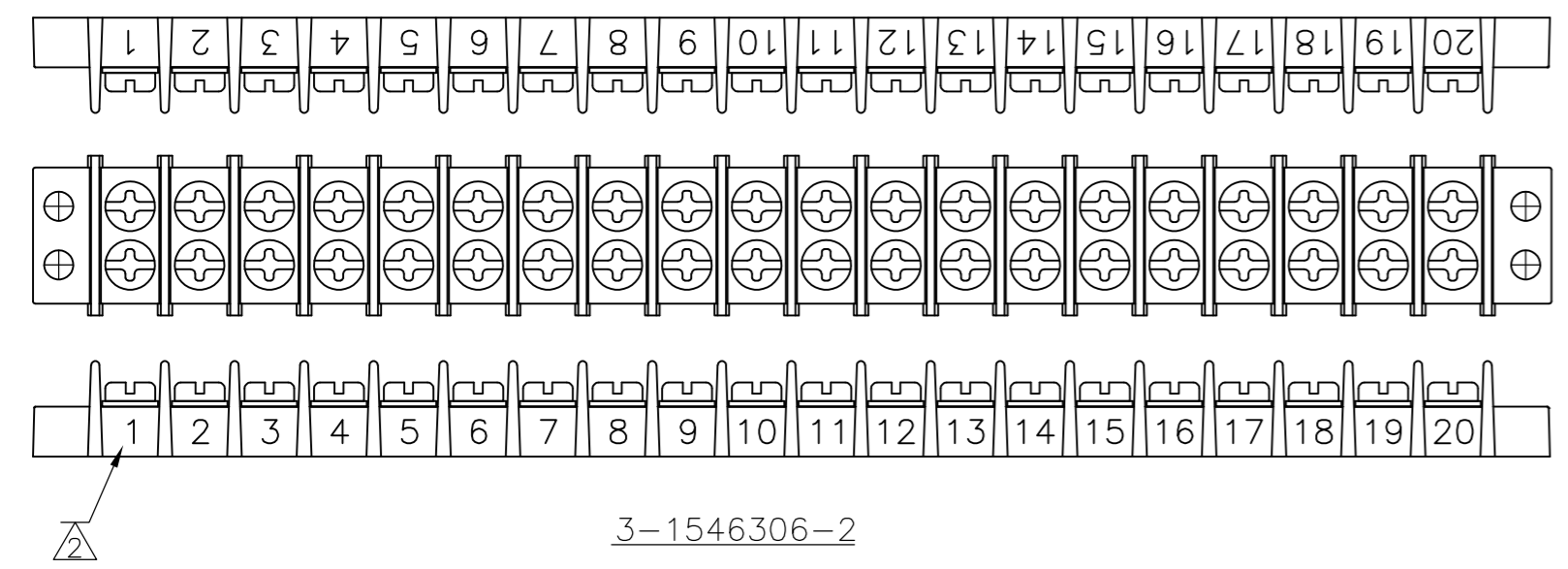
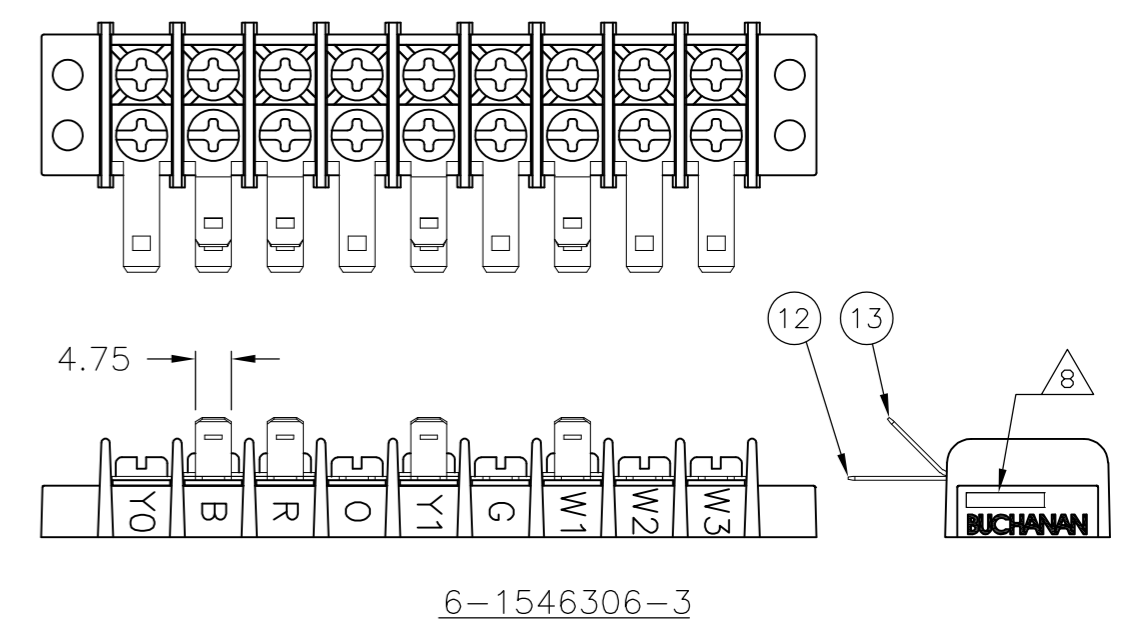

THIS DRAWING IS A CONTROLLED DOCUMENT.		DWN S SCHLEGEL 20AUG2002		
DIMENSIONS: MM		CHK C RICHARD 8/20/02		
TOLERANCES UNLESS OTHERWISE SPECIFIED:		APVD C RICHARD 8/20/02	NAME 9.50MM (.374) DBL ROW BARRIER STRIP W/O WASHER	
0 PLC ± -		PRODUCT SPEC	SIZE A2	
1 PLC ± 0.3		APPLICATION SPEC	CAGE CODE 00779	
2 PLC ± 0.25		WEIGHT	DRAWING NO C=1546306	
3 PLC ± -		FINISH	RESTRICTED TO	
4 PLC ± -		CUSTOMER DRAWING	SCALE NTS	
ANGLES ± 2°			SHEET 3 OF 3	
FINISH			REV H2	

X-ON Electronics

Largest Supplier of Electrical and Electronic Components

Click to view similar products for [Barrier Terminal Blocks](#) category:

Click to view products by [TE Connectivity](#) manufacturer:

Other Similar products are found below :

[6C1N03](#) [6PCR-02-008](#) [6PCR-05-008](#) [6PCR-08-008](#) [6PCR-21-006](#) [6PCV-06-008](#) [6PCV-10-009](#) [6PCV-15-008](#) [6STR-06-006](#) [6STR-08-006](#)
[6STR-12-008](#) [6STR-14-008](#) [6STR-16-008](#) [6STR-17-008](#) [6STR-21-008](#) [6STR-25-008](#) [6STR-27-008](#) [6STV-03-006](#) [6STV-03-008](#) [6STV-04-006](#) [6STV-10-006](#) [6WWR-03](#) [6WWV-12-008](#) [6WWV-16-008](#) [7-1546701-0](#) [72212603](#) [72503-C](#) [72504-C-50](#) [73203](#) [76007](#) [7604-501LF](#)
[77010-50](#) [796985-3](#) [796988-4](#) [7C1N08](#) [8-1437402-5](#) [8-1437402-7](#) [8-1546158-0](#) [870505](#) [870903](#) [8PCR-06-006](#) [8PCV-02-008](#) [8PCV-05-008](#)
[8PCV-09-006](#) [8PCV-15-006](#) [8PCV-17-006](#) [8QCR-03-008](#) [8STV-04-006](#) [9-1437402-3](#) [A103104](#)