

THIS DRAWING IS UNPUBLISHED. RELEASED FOR PUBLICATION
 © COPYRIGHT - By - ALL RIGHTS RESERVED.

LOC	DIST	REVISIONS					
		P	LTR	DESCRIPTION	DATE	DWN	APVD
			D9	REVISED PER ECO-12-012202	03JUL12	KH	MS







PHYSICAL PROPERTIES:
 HOUSING MATERIAL: PBT
 FLAMMABILITY: UL94V-0
 COLOR: BLACK











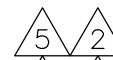

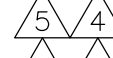
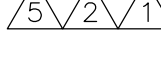

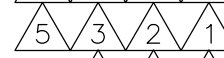
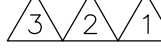
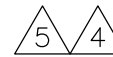
TERMINAL:
 TERMINALS: BRASS, TIN PLATED
 SCREWS: 6-32, STEEL, NICKEL PLATED

MECHANICAL:
 PITCH (TERMINAL SPACING): 9.50mm (.374")
 WIRE RANGE: 12-22 AWG
 RECOMMENDED TIGHTENING TORQUE: 12IN-LBS MAX.

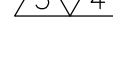
ELECTRICAL PROPERTIES:
 MAXIMUM CURRENT: 20A
 OPERATING VOLTAGE: 300V

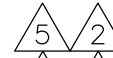
ENVIRONMENTAL PROPERTIES:
 OPERATING TEMP RANGE: -40°C TO 120°C

-  SCREWS ON ONE SIDE IN WIRE READY POSITION.
-  SEE FIGURE.
-  WHITE INK STAMP.
-  NICKEL PLATED BRASS SCREWS.
-  PRELIMINARY PART NUMBER.
-  TE CONNECTIVITY LOGO LOCATED APPROXIMATE AREA SHOWN.

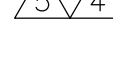
	DIM B	DIM A	QC TAB .187 45° (2)	QC TAB .187 FLAT (1)	NO OF POSN	PART NUMBER
	104.7	112.2	-	-	10	4-1546307-7
	104.7	112.2	-	-	10	4-1546307-6
	104.7	112.2	-	-	10	4-1546307-5
	104.7	112.2	-	-	10	3-1546307-3
	104.7	112.2	-	-	10	1-1546307-0
	95.2	102.7	-	9	9	5-1546307-0
	95.2	102.7	4	9	9	4-1546307-9
	95.2	102.7	4	9	9	4-1546307-8
	95.2	102.7	-	-	9	1546307-9
	85.7	93.2	-	-	8	1546307-8
	76.2	83.7	-	-	7	1546307-7
	66.7	74.2	-	-	6	4-1546307-4
	66.7	74.2	-	-	6	1546307-6
	57.2	64.7	-	-	5	4-1546307-3
	57.2	64.7	-	-	5	4-1546307-2
	57.2	64.7	-	-	5	4-1546307-1
	57.2	64.7	-	-	5	4-1546307-0
	57.2	64.7	-	-	5	3-1546307-9
	57.2	64.7	-	-	5	1546307-5
	47.7	55.2	-	-	4	3-1546307-2
	47.7	55.2	-	-	4	1546307-4
	38.2	45.7	-	-	3	3-1546307-8
	38.2	45.7	-	-	3	3-1546307-7
	38.2	45.7	-	-	3	3-1546307-6
	38.2	45.7	-	-	3	3-1546307-5
	38.2	45.7	-	-	3	3-1546307-4
	38.2	45.7	-	-	3	1546307-3
	28.7	36.2	-	-	2	1546307-2

THIS DRAWING IS A CONTROLLED DOCUMENT.		DWN S SCHLEGEL 20AUG2002	 TE Connectivity														
		CHK C RICHARD 8/20/02															
DIMENSIONS: mm		APVD C RICHARD 8/20/02	NAME 9.50MM (.374) DBL ROW BARRIER STRIP W/ WASHER														
TOLERANCES UNLESS OTHERWISE SPECIFIED:		PRODUCT SPEC	APPLICATION SPEC														
<table border="0"> <tr><td>0 PLC</td><td>± -</td></tr> <tr><td>1 PLC</td><td>± 0.3</td></tr> <tr><td>2 PLC</td><td>± 0.25</td></tr> <tr><td>3 PLC</td><td>± -</td></tr> <tr><td>4 PLC</td><td>± -</td></tr> <tr><td>ANGLES</td><td>± 2'</td></tr> </table>		0 PLC	± -	1 PLC	± 0.3	2 PLC	± 0.25	3 PLC	± -	4 PLC	± -	ANGLES	± 2'	SIZE A3	CAGE CODE 00779	DRAWING NO C-1546307	RESTRICTED TO -
0 PLC	± -																
1 PLC	± 0.3																
2 PLC	± 0.25																
3 PLC	± -																
4 PLC	± -																
ANGLES	± 2'																
MATERIAL -		FINISH -	CUSTOMER DRAWING		SCALE 1:1												
				SHEET 1 OF 3	REV D9												

THIS DRAWING IS UNPUBLISHED. RELEASED FOR PUBLICATION
 © COPYRIGHT - By - ALL RIGHTS RESERVED.

LOC	DIST	REVISIONS					
		P	LTR	DESCRIPTION	DATE	DWN	APVD
-	-	-	-	SEE SHEET 1	-	-	-



3-1546307-1



3-1546307-5



3-1546307-2



3-1546307-7

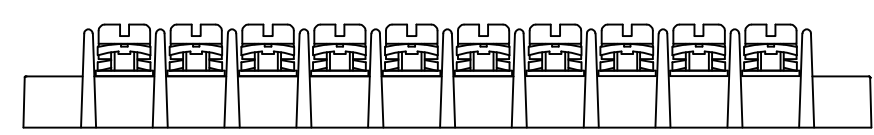
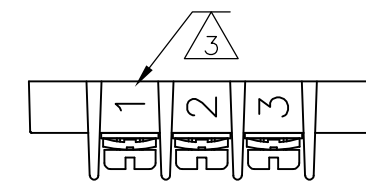
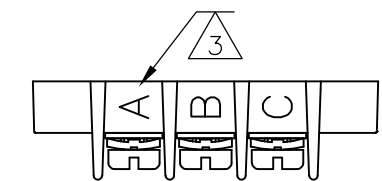

3-1546307-3

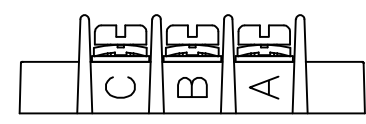
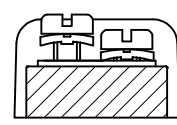

3-1546307-8

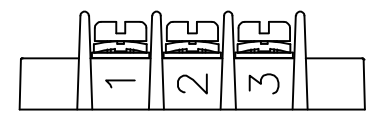
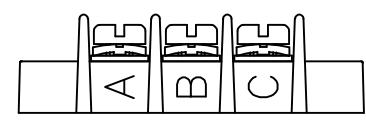

3-1546307-6

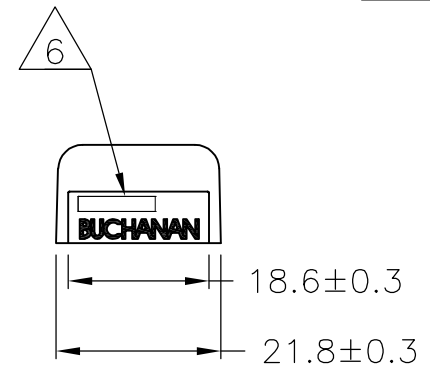
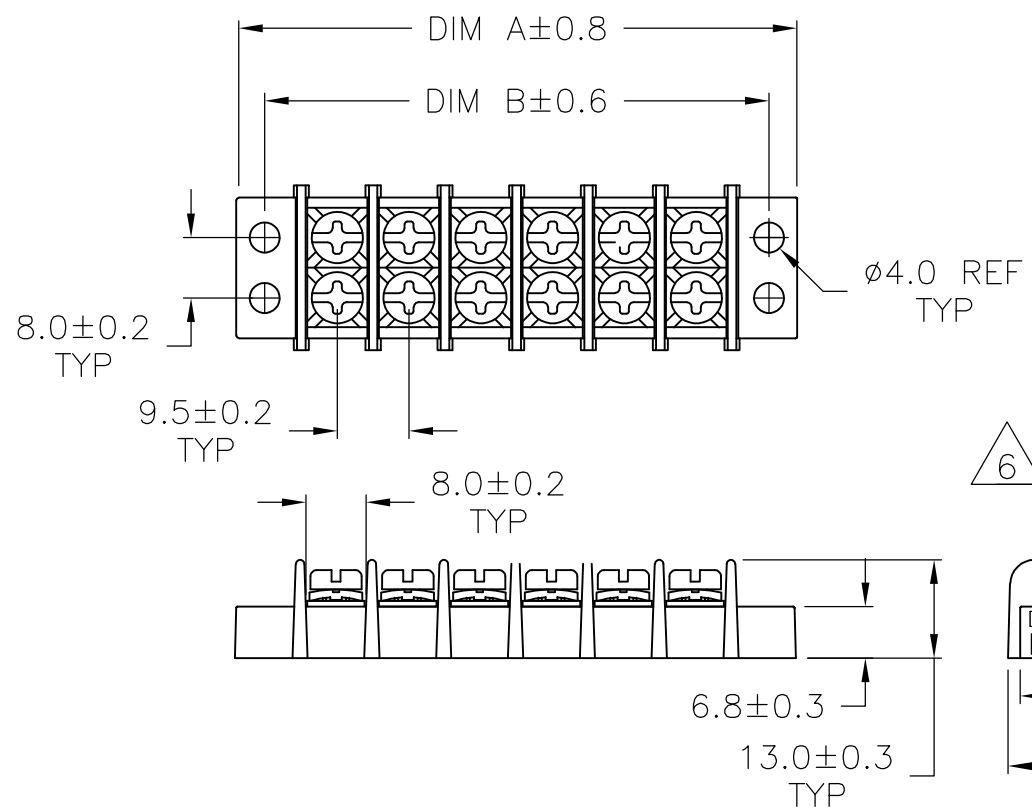

294.7	302.2	-	-	30	3-1546307-0
285.2	292.7	-	-	29	2-1546307-9
275.7	283.2	-	-	28	2-1546307-8
266.2	273.7	-	-	27	2-1546307-7
256.7	264.2	-	-	26	2-1546307-6
247.2	254.7	-	-	25	2-1546307-5
237.7	245.2	-	-	24	2-1546307-4
228.2	235.7	-	-	23	2-1546307-3
218.7	226.2	-	-	22	2-1546307-2
209.2	216.7	-	-	21	2-1546307-1
199.7	207.2	-	-	20	3-1546307-1
199.7	207.2	-	-	20	2-1546307-0
190.2	197.7	-	-	19	1-1546307-9
180.7	188.2	-	-	18	1-1546307-8
171.2	178.7	-	-	17	1-1546307-7
161.7	169.2	-	-	16	1-1546307-6
152.2	159.7	-	-	15	1-1546307-5
142.7	150.2	-	-	14	1-1546307-4
133.2	140.7	-	-	13	1-1546307-3
123.7	131.2	-	-	12	1-1546307-2
114.2	121.7	-	-	11	1-1546307-1
DIM B	DIM A	QC TAB .187 45° (2)	QC TAB .187 FLAT (1)	NO OF POSN	PART NUMBER

THIS DRAWING IS A CONTROLLED DOCUMENT.	
DIMENSIONS: mm	TOLERANCES UNLESS OTHERWISE SPECIFIED: 0 PLC ± - 1 PLC ± 0.3 2 PLC ± 0.25 3 PLC ± - 4 PLC ± - ANGLES ± 2'
MATERIAL -	FINISH -

DWN	S SCHLEGEL	20AUG2002
CHK	C RICHARD	8/20/02
APVD	C RICHARD	8/20/02
PRODUCT SPEC	-	-
APPLICATION SPEC	-	-
WEIGHT	-	-
CUSTOMER DRAWING		

STE TE Connectivity			
NAME 9.50MM (.374) DBL ROW BARRIER STRIP W/ WASHER			
SIZE	CAGE CODE	DRAWING NO	RESTRICTED TO
A3	00779	C-1546307	-
SCALE 1:1		SHEET 2 OF 3	REV D9

THIS DRAWING IS UNPUBLISHED.

RELEASED FOR PUBLICATION

ALL RIGHTS RESERVED.

© COPYRIGHT - By -

LOC -

DIST -

P

LTR

REVISIONS

DESCRIPTION

DATE

DWN

APVD

SEE SHEET 1

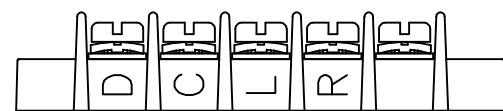
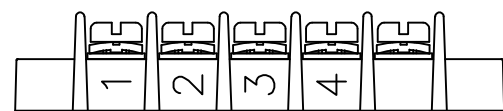
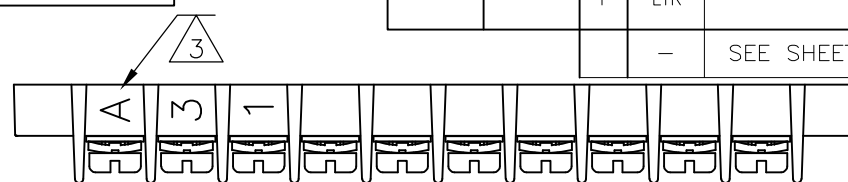
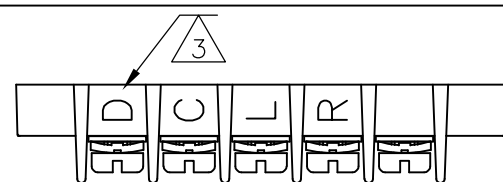
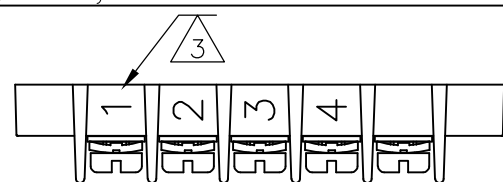

4-1546307-2

4-1546307-3

4-1546307-7

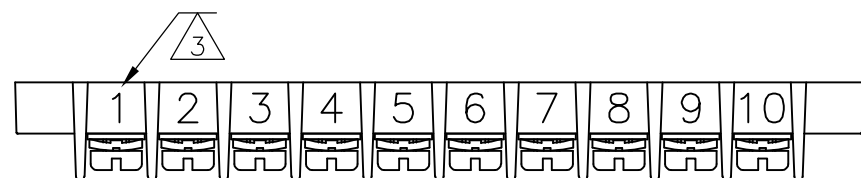

4-1546307-6

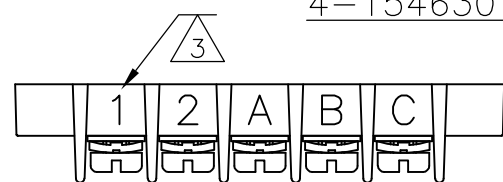

4-1546307-0

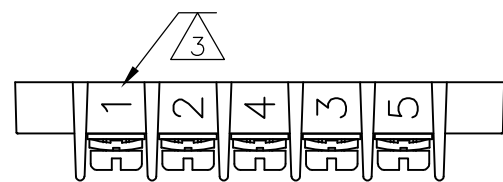

4-1546307-1

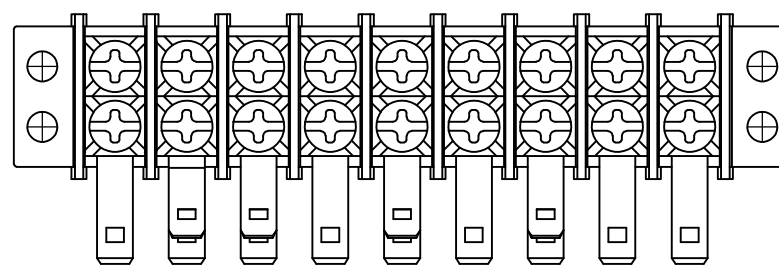
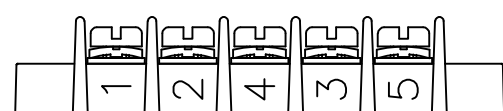

4-1546307-8

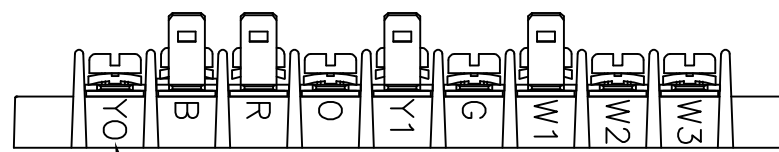

MARK BOTH SIDES

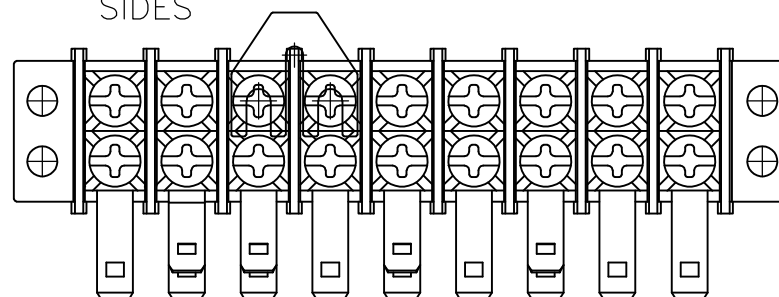

4-1546307-9

MARK BOTH SIDES

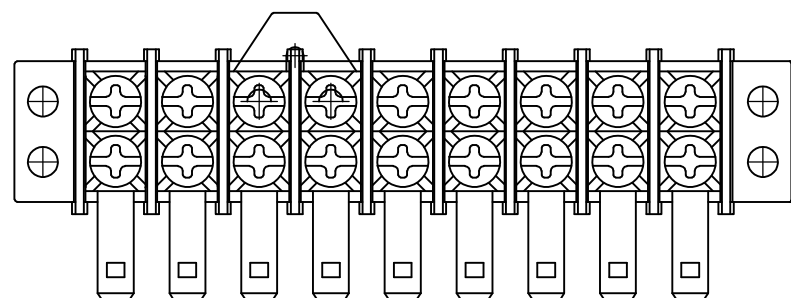
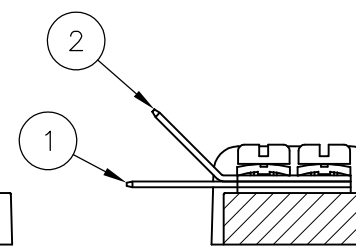
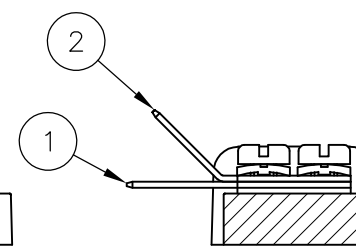

5-1546307-0

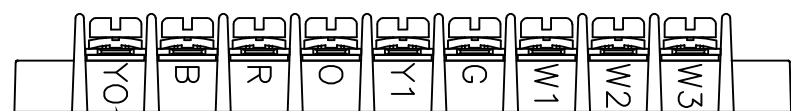

MARK BOTH SIDES

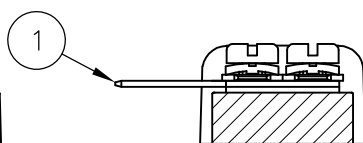

THIS DRAWING IS A CONTROLLED DOCUMENT.

DIMENSIONS:

mm

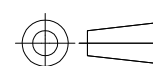

TOLERANCES UNLESS OTHERWISE SPECIFIED:

0 PLC	± -
1 PLC	± 0.3
2 PLC	± 0.25
3 PLC	± -
4 PLC	± -
ANGLES	± 2'
FINISH	-

MATERIAL

-

DWN 20AUG2002

S SCHLEGEL

CHK 8/20/02

C RICHARD

APVD 8/20/02

C RICHARD

PRODUCT SPEC

APPLICATION SPEC

WEIGHT

-

STE TE Connectivity

NAME
9.50MM (.374) DBL ROW BARRIER STRIP
W/ WASHER

SIZE	CAGE CODE	DRAWING NO	RESTRICTED TO
A3	00779	C-1546307	-

CUSTOMER DRAWING

SCALE 1:1

SHEET 3 OF 3

REV D9

X-ON Electronics

Largest Supplier of Electrical and Electronic Components

Click to view similar products for [Barrier Terminal Blocks](#) category:

Click to view products by [TE Connectivity](#) manufacturer:

Other Similar products are found below :

[CR151D20104](#) [670A-RZ-15-KT20](#) [6C1N03](#) [6PCR-02](#) [6PCR-02-008](#) [6PCR-05-008](#) [6PCR-08-008](#) [6PCR-09-008](#) [6PCR-13-006](#) [6PCR-15-006](#) [6PCR-21-006](#) [6PCV-06-008](#) [6PCV-06-716](#) [6PCV-09-001](#) [6PCV-10-009](#) [6PCV-15-008](#) [6PCV-17-1206](#) [6PCV-20-323](#) [6PCV-20-720](#) [6PCV-30-006](#) [6STR-06-006](#) [6STR-08-006](#) [6STR-12-008](#) [6STR-13-006](#) [6STR-14-008](#) [6STR-16-008](#) [6STR-17-008](#) [6STR-21-008](#) [6STR-25-008](#) [6STR-27-008](#) [6STV-03-006](#) [6STV-03-008](#) [6STV-04-006](#) [6STV-09-006](#) [6STV-10-006](#) [6WWR-03-693](#) [6WWV-12-008](#) [72212603](#) [72504-C-50](#) [72506-C](#) [72507-C-50](#) [73203](#) [75505-C](#) [75505-C-50](#) [75510-C](#) [77010-50](#) [7C1N08](#) [812-GP-3/4ST-09](#) [8-1437402-5](#) [8PCR-06-006](#)