

4

3

2

1

THIS DRAWING IS UNPUBLISHED. RELEASED FOR PUBLICATION  
 © COPYRIGHT - TE Connectivity Ltd. ALL RIGHTS RESERVED.

REVISIONS 変更				
P	LTR	DESCRIPTION	DATE	APVD
	A1	REVISED PER ECR-19-006211	17APR2019	SC D.Z

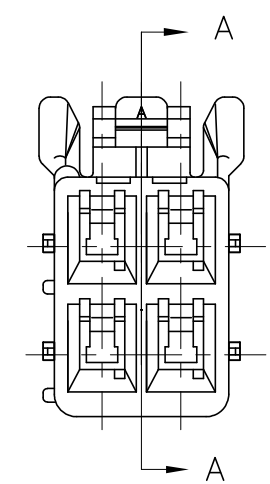
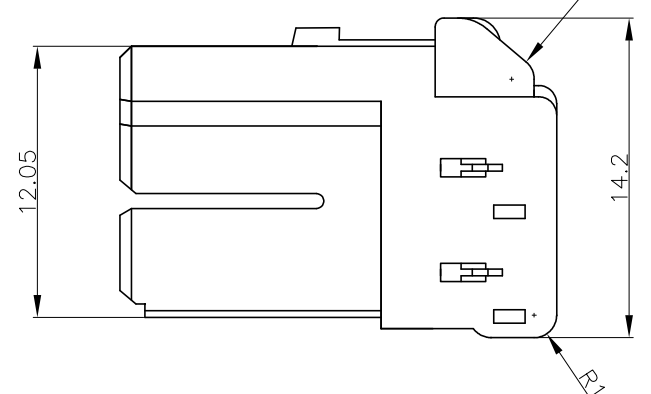
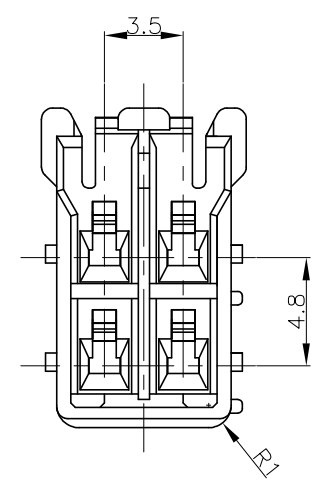
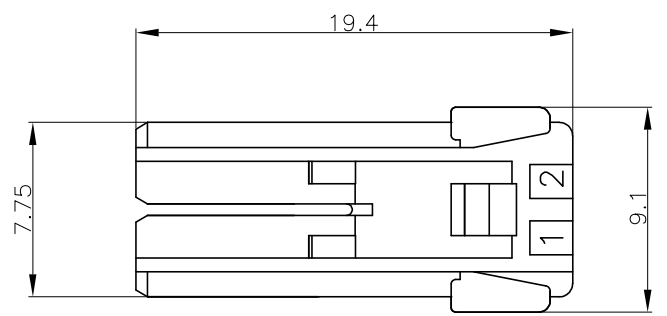

KEYING TYPE

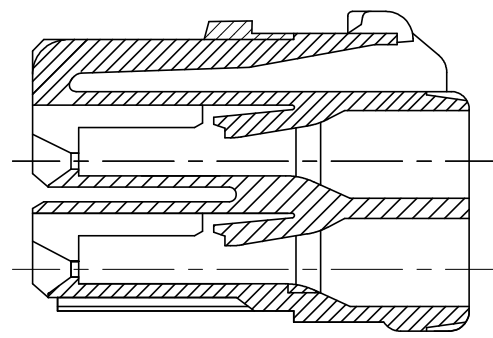
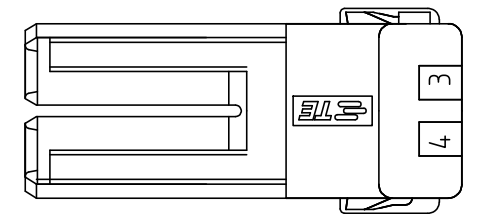
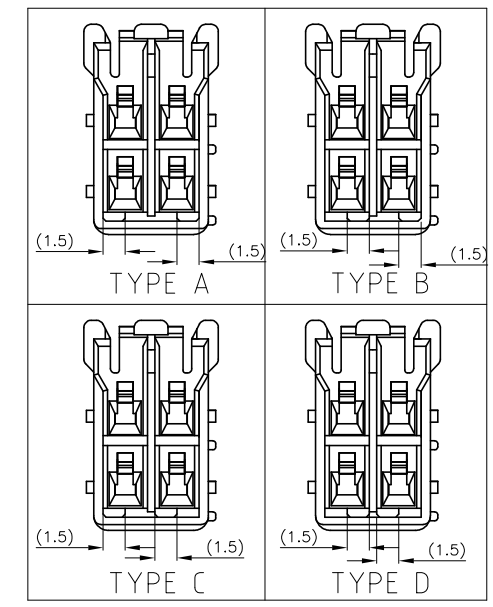

SECT A-A

3-1565087-4	D	YELLOW	3-1565083-4
2-1565087-3	C	BLUE	2-1565083-3
1-1565087-2	B	RED	1-1565083-2
1565087-1	A	NATURAL	1565083-1
MATING HSG P/N	KEYING TYPE	COLOR	P/N

注) 1.一般公差:±0.25  
 2.材料:66ナイロン ガラス無(UL94V-0)  
 3.かん合相手製品型番  
 キャップハウジング:TABLE?照のこと  
 リセコンタクト:1565079-1,1612334-1  
 4.適?プレ?ト型番:1565089-1

NOTES)  
 1.GENERAL TOLERANCE:±0.25  
 2.MATERIAL:66 NYLON NON-GLOSS FILLED (UL94V-0)  
 3.MATING CONN. P/N  
 CAP HOUSING:SEE TABLE  
 REC CONTACT ;1565079-1,1612334-1  
 4. APPLICABLE PLATE P/N :1565089-1

THIS DRAWING IS A CONTROLLED DOCUMENT.		DWN A.OISHI 30 MAY. '02	TE Connectivity Ltd.	
DIMENSIONS: 単位: 耗 mm		CHK M.SHINDO 30 MAY. '02		
TOLERANCES UNLESS OTHERWISE SPECIFIED: 一般公差		APVD M.SHINDO 30 MAY. '02	GRACE INERTIA CONNECTOR 3.5 4POS PLUG HOUSING	
		PRODUCT SPEC 製品規格 108-5810	グレイス?イナーシャ?コネクタ 3.5 4極 プラグハウジ	
MATERIAL 材料 SEE NOTE 2		APPLICATION SPEC 取付適用規格 114-5306	SIZE A3	RESTRICTED TO
FINISH 仕上		WEIGHT -	CAGE CODE 00779	DRAWING NO 番号 C=1565083
		CUSTOMER DRAWING	SCALE 尺度	SHEET 1 OF 1
				REV A1

## X-ON Electronics

Largest Supplier of Electrical and Electronic Components

*Click to view similar products for [TE Connectivity](#) manufacturer:*

Other Similar products are found below :

[D38999/24FJ4AN](#) [570416-000](#) [CLTEQ-M81CE-SSRELAY-4-20V](#) [4-1195131-0](#) [650069-000](#) [SMD100-2](#) [358838-000](#) [CB-1022B-78](#)  
[RM707012](#) [RP410012](#) [MMS42](#) [1-640426-8](#) [2EDL4CM](#) [DTS20W19-11PD-3028-LC](#) [RM202615](#) [NC6-P104-06](#) [MSPS103B](#) [DTS26F21-](#)  
[41HE-LC](#) [DTS26F21-41AE](#) [DTS26F21-41PE-LC](#) [DTS26F21-11SE-3028-LC](#) [30DCB6](#) [1932144-1](#) [293545-4](#) [LVR125S](#) [MS27466T25F4PB](#)  
[CKB-38-78010](#) [TR04AI-TINELLOCKRING](#) [1206SFF150F/63-2](#) [D38999/20JB35HA](#) [TE1500A2R2J](#) [D38999/20WC8BB](#) [DTS24F19-11SC-](#)  
[3028-LC](#) [D38999/24WG11HA](#) [D38999/24WG11HN](#) [MS27467T21F11H](#) [DJT16E21-11HA](#) [MS27467T21F35J](#) [MS27467T21F11J](#)  
[MS27467T21F16H-LC](#) [MS27467T21F35H](#) [MS27467T21F41H-LC](#) [1206SFH150F/24-2](#) [RP330024](#) [DJT16E21-11PA-LC](#) [DJT16E21-11HA-](#)  
[LC](#) [DJT16E21-11AA](#) [MS27467T21B11JA](#) [DJT16E21-11JA](#) [MS27467T21B11JA-LC](#)