

THIS DRAWING IS UNPUBLISHED.

RELEASED FOR PUBLICATION

© COPYRIGHT - BY TYCO ELECTRONICS CORPORATION. ALL INTERNATIONAL RIGHTS RESERVED.

LOC		DIST		REVISIONS			
P	LTR	DESCRIPTION		DATE	DWN	APVD	
	A1	ECR-17-009675		04JUL17	MG	BM	

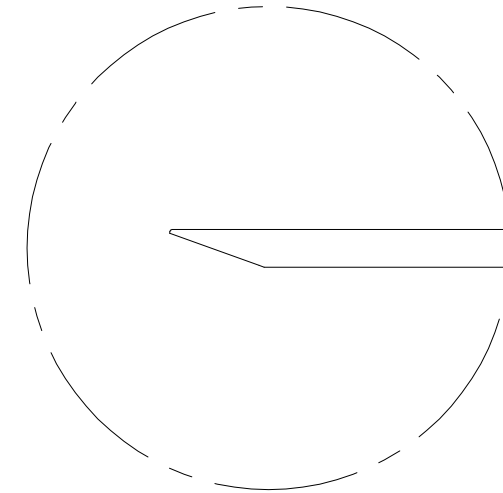
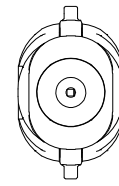
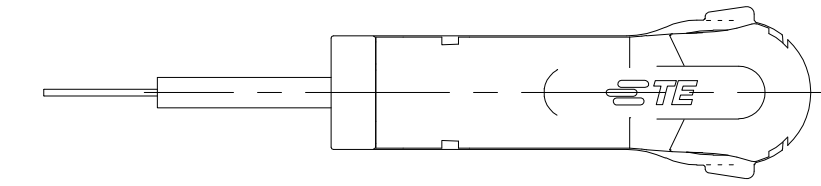

B

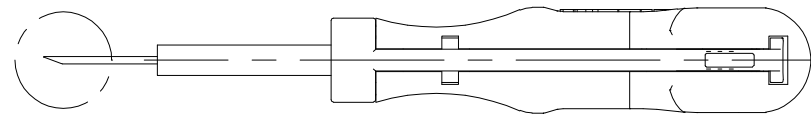

B

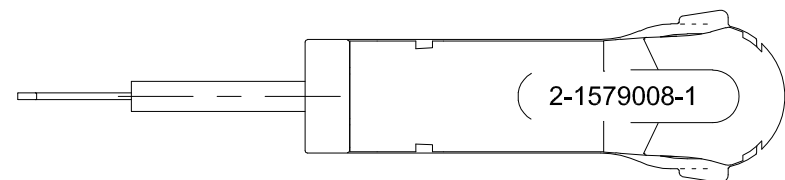
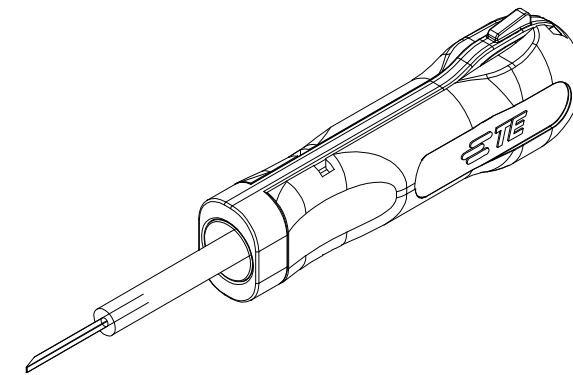

2-1579008-1

THIS DRAWING IS A CONTROLLED DOCUMENT.

DWN 06.11.2006

m.pearson

CHK



DIMENSIONS:

mm

TOLERANCES UNLESS OTHERWISE SPECIFIED:

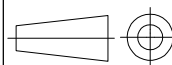

0 PLC	± -
1 PLC	± -
2 PLC	± -
3 PLC	± -
4 PLC	± -
ANGLES	± -

MATERIAL

FINISH

APVD

PRODUCT SPEC

APPLICATION SPEC

WEIGHT

0.016 kg

NAME

EXTRACTION TOOL
Entriegelungswerkzeug

SIZE

CAGE CODE

DRAWING NO

RESTRICTED TO

A3

00779

C-2-1579008-1

-

CUSTOMER DRAWING

SCALE 1:1

SHEET 1 OF 1

REV A1

X-ON Electronics

Largest Supplier of Electrical and Electronic Components

Click to view similar products for [Extraction, Removal & Insertion Tools](#) category:

Click to view products by [TE Connectivity](#) manufacturer:

Other Similar products are found below :

[M8196914-08](#) [768211-2](#) [809-131](#) [844751-2](#) [8-59558-2](#) [91018-1](#) [12014013](#) [12093647](#) [1-21048-0](#) [R282867020](#) [12093078](#) [1-21048-6](#)
[12121897](#) [DCF.91.405.5LT](#) [1322](#) [15314260](#) [15350698](#) [15350707](#) [15430130](#) [1579018-4](#) [1643916-1](#) [1-679532-0](#) [1976593-3](#) [OUTEXT-0321](#)
[2-1579008-3](#) [2-1579008-4](#) [229694-7](#) [231106-1](#) [241469](#) [91040-3](#) [91040-7](#) [965004-000](#) [965069-000](#) [1738219-1](#) [ET-JL05-16](#) [FG 0300 146](#)
[3000](#) [FIT-6](#) [210S048](#) [2-1579007-9](#) [231879-1](#) [312138-3](#) [RJ11FODE](#) [356-162](#) [M8196914-10](#) [4-1579018-0](#) [430395-001](#) [483249-1](#) [5-](#)
[1579007-2](#) [5-1579007-9](#) [BPR10](#)