

REVISIONS				
#	DATE	DESCRIPTION	BY	APP'D
1	29MAY2019	REVISED PER ECR-19-008349	AL	HL

- 1 HOUSING: LCP, BLACK.
CONTACT & GROUND PLANE: PHOS BRONZE.
- 2 CONTACT PLATING: SELECT 0.25 MICROMETERS (.000010 IN) MIN. GOLD.
- 3 FOR STANDARD APPLICATIONS, ORIENTATION HOLE TO BE Ø1.02 [Ø.0400].
- 4 OBSOLETE PARTS: OBSOLETE CIS STREAMLINING PER D.RENAUD/D.SINISI

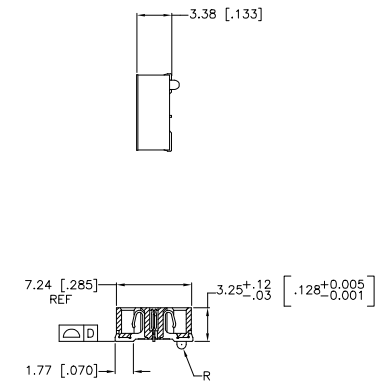

SECTION A-A

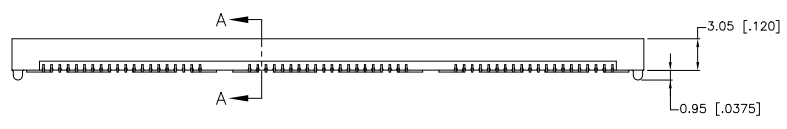
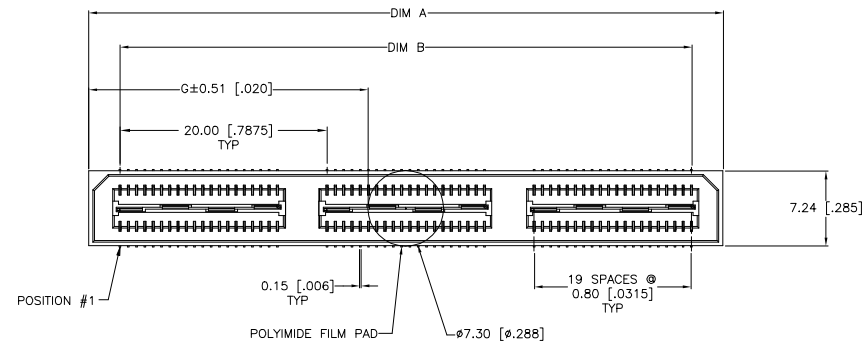
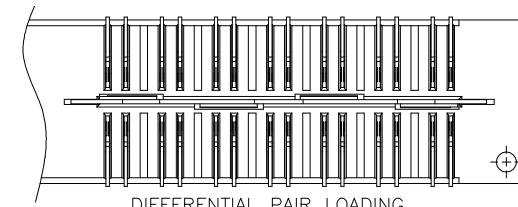
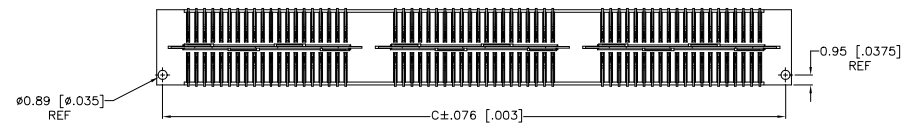

DIFFERENTIAL PAIR LOADING (BOTTOM VIEW) SCALE 2:1

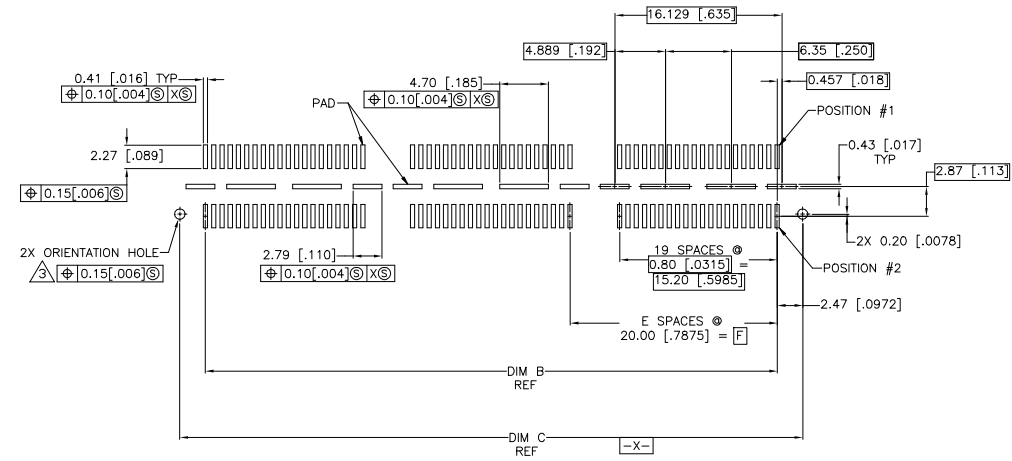

RECOMMENDED PC BOARD LAYOUT VIEWED FROM CONNECTOR SIDE

26.99(1.063)	40.00(1.575)	2	0.152(.006)	60.13(2.368)	55.20(2.173)	61.28(2.412)	YES	POCKET TAPE	YES	84	7-1658012-3
16.98(.669)	20.00(.7874)	1	0.102(.004)	40.13(1.580)	35.20(1.386)	41.28(1.625)	YES	POCKET TAPE	YES	56	7-1658012-2
6.99(.275)	0(.000)	0	0.102(.004)	20.13(.793)	15.20(.598)	21.29(.838)	YES	POCKET TAPE	YES	28	7-1658012-1
26.99(1.063)	40.00(1.575)	2	0.152(.006)	60.13(2.368)	55.20(2.173)	61.28(2.412)	YES	POCKET TAPE	NO	120	6-1658012-3
16.98(.669)	20.00(.7874)	1	0.102(.004)	40.13(1.580)	35.20(1.386)	41.28(1.625)	YES	POCKET TAPE	NO	80	6-1658012-2
6.99(.275)	0(.000)	0	0.102(.004)	20.13(.793)	15.20(.598)	21.29(.838)	YES	POCKET TAPE	NO	40	6-1658012-1
-	40.00(1.575)	2	0.152(.006)	60.13(2.368)	55.20(2.173)	61.28(2.412)	NO	POCKET TAPE	YES	84	5-1658012-3
-	20.00(.7874)	1	0.102(.004)	40.13(1.580)	35.20(1.386)	41.28(1.625)	NO	POCKET TAPE	YES	56	5-1658012-2
-	0(.000)	0	0.102(.004)	20.13(.793)	15.20(.598)	21.29(.838)	NO	POCKET TAPE	YES	28	5-1658012-1
-	40.00(1.575)	2	0.152(.006)	60.13(2.368)	55.20(2.173)	61.28(2.412)	NO	POCKET TAPE	NO	120	4-1658012-3
-	20.00(.7874)	1	0.102(.004)	40.13(1.580)	35.20(1.386)	41.28(1.625)	NO	POCKET TAPE	NO	80	4-1658012-2
-	0(.000)	0	0.102(.004)	20.13(.793)	15.20(.598)	21.29(.838)	NO	POCKET TAPE	NO	40	4-1658012-1
47.00(1.850)	80.00(3.150)	4	0.152(.006)	100.14(3.943)	95.20(3.748)	101.30(3.988)	YES	TRAY	YES	140	3-1658012-5
36.99(1.456)	60.00(2.362)	3	0.152(.006)	80.14(3.155)	75.20(2.961)	81.28(3.200)	YES	TRAY	YES	112	3-1658012-4
26.99(1.063)	40.00(1.575)	2	0.152(.006)	60.13(2.368)	55.20(2.173)	61.28(2.412)	YES	TRAY	YES	84	3-1658012-3
16.98(.669)	20.00(.7874)	1	0.102(.004)	40.13(1.580)	35.20(1.386)	41.28(1.625)	YES	TRAY	YES	56	3-1658012-2
6.99(.275)	0(.000)	0	0.102(.004)	20.13(.793)	15.20(.598)	21.29(.838)	YES	TRAY	YES	28	3-1658012-1
47.00(1.850)	80.00(3.150)	4	0.152(.006)	100.14(3.943)	95.20(3.748)	101.30(3.988)	YES	TRAY	NO	200	2-1658012-5
36.99(1.456)	60.00(2.362)	3	0.152(.006)	80.14(3.155)	75.20(2.961)	81.28(3.200)	YES	TRAY	NO	160	2-1658012-4
26.99(1.063)	40.00(1.575)	2	0.152(.006)	60.13(2.368)	55.20(2.173)	61.28(2.412)	YES	TRAY	NO	120	2-1658012-3
16.98(.669)	20.00(.7874)	1	0.102(.004)	40.13(1.580)	35.20(1.386)	41.28(1.625)	YES	TRAY	NO	80	2-1658012-2
6.99(.275)	0(.000)	0	0.102(.004)	20.13(.793)	15.20(.598)	21.29(.838)	YES	TRAY	NO	40	2-1658012-1
-	80.00(3.150)	4	0.152(.006)	100.14(3.943)	95.20(3.748)	101.30(3.988)	NO	TRAY	YES	140	1-1658012-5
-	60.00(2.362)	3	0.152(.006)	80.14(3.155)	75.20(2.961)	81.28(3.200)	NO	TRAY	YES	112	1-1658012-4
-	40.00(1.575)	2	0.152(.006)	60.13(2.368)	55.20(2.173)	61.28(2.412)	NO	TRAY	YES	84	1-1658012-3
-	20.00(.7874)	1	0.102(.004)	40.13(1.580)	35.20(1.386)	41.28(1.625)	NO	TRAY	YES	56	1-1658012-2
-	0(.000)	0	0.102(.004)	20.13(.793)	15.20(.598)	21.29(.838)	NO	TRAY	YES	28	1-1658012-1
-	80.00(3.150)	4	0.152(.006)	100.14(3.943)	95.20(3.748)	101.30(3.988)	NO	TRAY	NO	200	1658012-5
-	60.00(2.362)	3	0.152(.006)	80.14(3.155)	75.20(2.961)	81.28(3.200)	NO	TRAY	NO	160	1658012-4
-	40.00(1.575)	2	0.152(.006)	60.13(2.368)	55.20(2.173)	61.28(2.412)	NO	TRAY	NO	120	1658012-3
-	20.00(.7874)	1	0.102(.004)	40.13(1.580)	35.20(1.386)	41.28(1.625)	NO	TRAY	NO	80	1658012-2
-	0(.000)	0	0.102(.004)	20.13(.793)	15.20(.598)	21.29(.838)	NO	TRAY	NO	40	1658012-1
G	F	E	D	C	B	A		POLYIMIDE FILM PAD			

THIS DRAWING IS A CONTROLLED DOCUMENT. DWG. NO. MCMMASTER 1658012-5

DIMENSIONS: mm (INCHES)

DATE: 29MAY2019

DESIGNER: J. DIXON

APP'D: J. DIXON

PRODUCT SPEC: RECEPTACLE ASSEMBLY, VERTICAL 0.80MM CL.

APPLICATION SPEC: -

MATERIAL: -

WEIGHT: -

SCALE: 4:1

DRAWING NO: A100779

PART NUMBER: C-1658012

SHEET 1 OF 1

REV N

X-ON Electronics

Largest Supplier of Electrical and Electronic Components

Click to view similar products for [Board to Board & Mezzanine Connectors](#) category:

Click to view products by [TE Connectivity](#) manufacturer:

Other Similar products are found below :

[589158040000018](#) [MDF7C-18P-2.54DSA\(55\)](#) [FCN-230C068-11](#) [FCN-268F012-G/BD](#) [FCN-268F036-G/BD](#) [FCN-268M012-G/0D](#) [FCN-268M024-G/1D](#) [FCN-723J004/1](#) [MIS-048-01-F-D-DP-K](#) [832-10-034-10-001000](#) [FX4C-80S-1.27DSA](#) [FCN-214Q030-G/0](#) [FCN-234P048-G/0](#) [FCN-235D050-G/C](#) [210-93-314-41-105000](#) [2-22603-0](#) [MDF7-40DP-2.54DSA\(55\)](#) [AXG720047](#) [5031084030](#) [MIT-114-03-F-D-K](#) [55323-1519](#) [DF33-2P-3.3DSA\(24\)](#) [YFT-20-05-H-03-SB-K](#) [503308-3040](#) [026-6203-PDB](#) [027-6203-PDB](#) [069159702701000](#) [10123981-102LF](#) [101A10019X](#) [55650-0588-C](#) [68684-306](#) [75140-7012](#) [589159005003045](#) [194261-1](#) [FCN-268F024-G0D](#) [10124054-515LF](#) [68685-603](#) [8-1616154-3](#) [MIS-019-01-F-D](#) [589159005002045](#) [541371078](#) [IL-WX-10PB-HF-B-E1000E](#) [FCN-268M024-G/3D](#) [20021832-06016C1LF](#) [KX15-20KLDL-E1000E](#) [MDF7-16DP-2.54DSA\(55\)](#) [AXE810124](#) [FCN-214J100-G/0](#) [FCN-230C068-E/S](#) [AXE812124](#)