

THIS DRAWING IS UNPUBLISHED. RELEASED FOR PUBLICATION AUG, 2006.

© COPYRIGHT BY TYCO ELECTRONICS CORPORATION. ALL RIGHTS RESERVED.

LOC	DIST	REVISIONS			
P	LTR	DESCRIPTION	DATE	DWN	APVD
DW	-	C	REVISED (ECR-13-003844)	04JUN13	JL WK

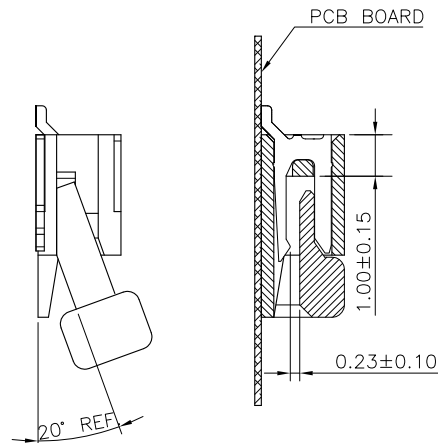
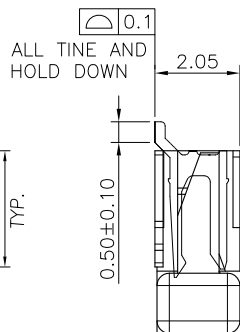
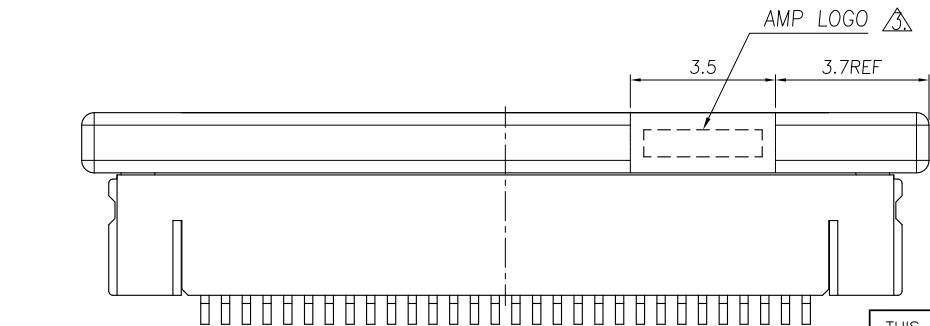
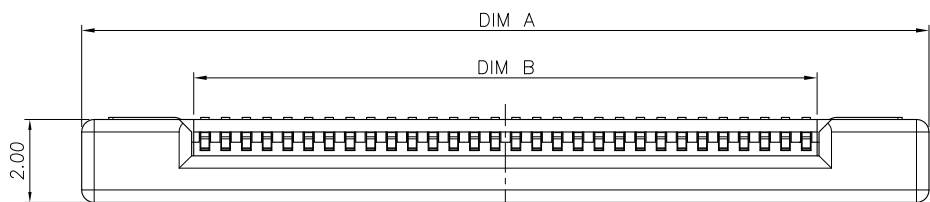
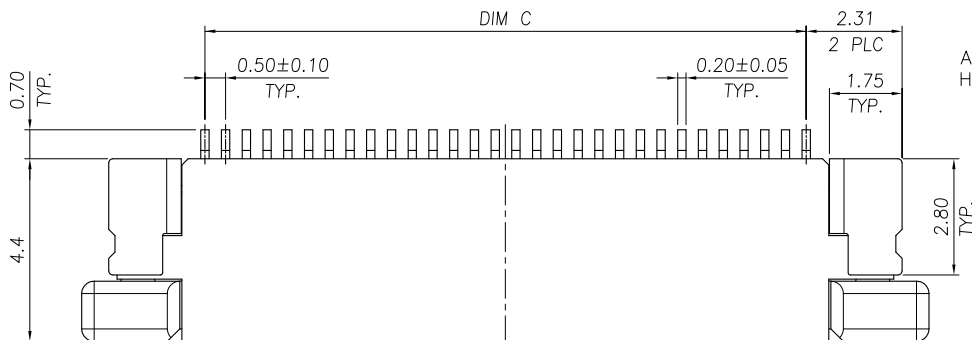

24.50	25.60	30.43	50	5-1734592-0
24.00	25.10	29.93	49	4-1734592-9
23.50	24.60	29.43	48	4-1734592-8
23.00	24.10	28.93	47	4-1734592-7
22.50	23.60	28.43	46	4-1734592-6
22.00	23.10	27.63	45	4-1734592-5
21.50	22.60	27.43	44	4-1734592-4
21.00	22.10	26.93	43	4-1734592-3
20.50	21.60	26.43	42	4-1734592-2
20.00	21.10	25.93	41	4-1734592-1
19.50	20.60	25.43	40	4-1734592-0
19.00	20.10	24.93	39	3-1734592-9
18.50	19.60	24.43	38	3-1734592-8
18.00	19.10	23.93	37	3-1734592-7
17.50	18.60	23.43	36	3-1734592-6
17.00	18.10	22.93	35	3-1734592-5
16.50	17.60	22.43	34	3-1734592-4
16.00	17.10	21.93	33	3-1734592-3
15.50	16.60	21.43	32	3-1734592-2
15.00	16.10	20.93	31	3-1734592-1
14.50	15.60	20.43	30	3-1734592-0
14.00	15.10	19.93	29	2-1734592-9
13.50	14.60	19.43	28	2-1734592-8
13.00	14.10	18.93	27	2-1734592-7
12.50	13.60	18.43	26	2-1734592-6
12.00	13.10	17.93	25	2-1734592-5
11.50	12.60	17.43	24	2-1734592-4
11.00	12.10	16.93	23	2-1734592-3
10.50	11.60	16.43	22	2-1734592-2
10.00	11.10	15.93	21	2-1734592-1
9.50	10.60	15.43	20	2-1734592-0
9.00	10.10	14.93	19	1-1734592-9
8.50	9.60	14.43	18	1-1734592-8
8.00	9.10	13.93	17	1-1734592-7
7.50	8.60	13.43	16	1-1734592-6
7.00	8.10	12.93	15	1-1734592-5
6.50	7.60	12.43	14	1-1734592-4
6.00	7.10	11.93	13	1-1734592-3
5.50	6.60	11.43	12	1-1734592-2
5.00	6.10	10.93	11	1-1734592-1
4.50	5.60	10.43	10	1-1734592-0
4.00	5.10	9.93	09	0-1734592-9
3.50	4.60	9.43	08	0-1734592-8
3.00	4.10	8.93	07	0-1734592-7
2.50	3.60	8.43	06	0-1734592-6
2.00	3.10	7.93	05	0-1734592-5
C	B	A	POS.	PART NUMBER
DIMENSIONS				

NOTE:

- MATERIAL:  
HOUSING: THERMOPLASTIC(LCP), UL 94V-0, COLOR: NATURE.  
ACTUATOR: THERMOPLASTIC, UL 94 V-0, COLOR: IVORY.  
HOLD DOWN: PHOSPHOR BRONZE.  
CONTACT: PHOSPHOR BRONZE.
- FINISH:  
CONTACT: GOLD FLASH OVER ALL, 50u" MIN. NICKEL UNDERPLATED ALL OVER.  
HOLD DOWN: 100u" MIN. BRIGHT TIN PLATING OVER, 50u" MIN. NICKEL UNDERPLATED ALL OVER.  
▲ WITHOUT AMP LOGO FOR 12 POSITION UNDER

THIS DRAWING IS A CONTROLLED DOCUMENT.		DWN J. LAI 15APR2009	<b>STE</b> TE Connectivity	
DIMENSIONS: MM		CHK S. CHIEN 15APR2009		
TOLERANCES UNLESS OTHERWISE SPECIFIED:		APVD W. KODAMA 15APR2009	NAME	
0 PLC ± -		PRODUCT SPEC	FPC CONNECTOR, 0.5mm PITCH, BOTTOM CONTACT, SMT TYPE.	
1 PLC ± 0.35		QUALIFICATION TEST REPORT	RESTRICTED TO	
2 PLC ± 0.25		501-57598	SIZE	CAGE CODE
3 PLC ± -		WEIGHT	DRAWING NO	
4 PLC ± -		- GRAMS	A3 00779 C=1734592	
ANGLES ± 3'		CUSTOMER DRAWING	SCALE	SHEET
MATERIAL	FINISH	SCALE -		SHEET 1 OF 3
SEE NOTE	SEE NOTE	REV C		

4

3

2

1

THIS DRAWING IS UNPUBLISHED.

RELEASED FOR PUBLICATION

AUG ,2006.

© COPYRIGHT BY TYCO ELECTRONICS CORPORATION.

ALL RIGHTS RESERVED.

LOC DW

DIST

REVISIONS

P	LTR	DESCRIPTION	DATE	DWN	APVD
		SEE SHEET 1.			

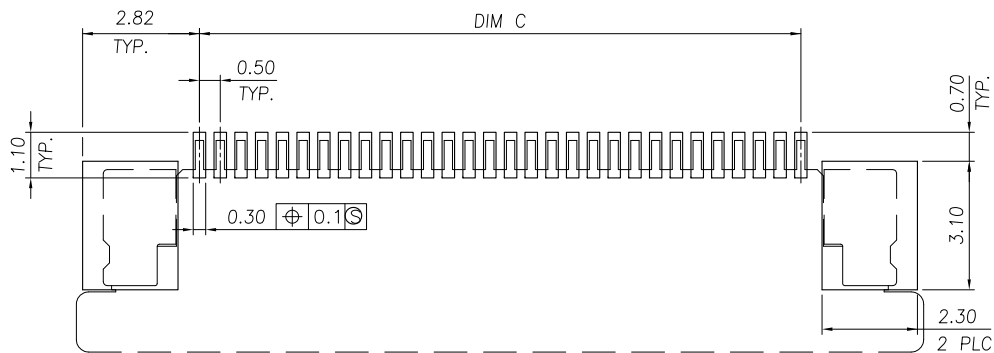

RECOMMENDED PCB DIMENSIONS DIAGRAM  
TOLERANCE ± 0.05

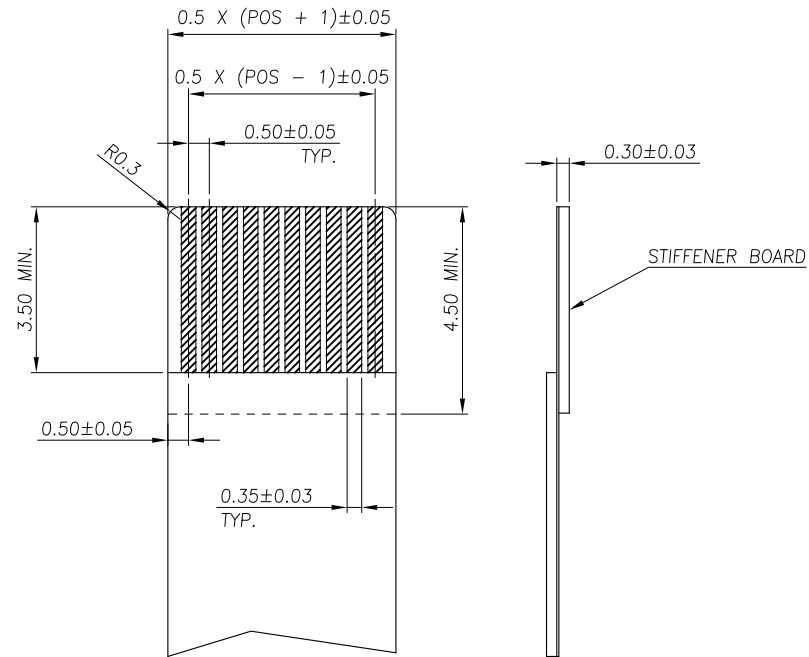

RECOMMENDED FPC DIMENSIONS DIAGRAM  
TOLERANCE ± 0.05

THIS DRAWING IS A CONTROLLED DOCUMENT.		DWN	<b>STE</b> TE Connectivity		
DIMENSIONS: MM		CHK			
TOLERANCES UNLESS OTHERWISE SPECIFIED:		APVD	NAME		
0 PLC ± -		PRODUCT SPEC	FPC CONNECTOR, 0.5mm PITCH, BOTTOM CONTACT, SMT TYPE.		
1 PLC ± 0.35		APPLICATION SPEC	SIZE	CAGE CODE	DRAWING NO
2 PLC ± 0.25		WEIGHT	A3	00779	G=1734592
3 PLC ± -		CUSTOMER DRAWING	SCALE	SHEET	REV
4 PLC ± -				2 OF 3	C
ANGLES ± 3°					
MATERIAL	FINISH				

LOC	DIST	REVISIONS			
P	LTR	DESCRIPTION	DATE	DWN	APVD
SEE SHEET 1.					



NOTE :

1. TAPE REEL:  
DIAMETER: 13", THICKNESS : 0.35±0.05mm.
2. CARTON:  
SIZE: 350mm(L)X 350mm(W)X 340mm(H).

APQ (PCS/CARTON)	PPQ (PCS/REEL)	D	C	B	A	POS.
12000	2000	44.00	26.70	30.55	31.50	50
		44.00	26.20	30.05	31.00	49
		44.00	25.70	29.55	30.50	48
		44.00	25.20	29.05	30.00	47
		44.00	24.70	28.55	29.50	46
		44.00	24.20	28.05	29.00	45
		44.00	23.70	27.55	28.50	44
		44.00	23.20	27.05	28.00	43
		44.00	22.70	26.55	27.50	42
		44.00	22.20	26.05	27.00	41
		44.00	21.70	25.55	26.50	40
		44.00	21.20	25.05	26.00	39
16000	2000	44.00	20.70	24.55	25.50	38
		44.00	20.20	24.05	25.00	37
		44.00	19.70	23.55	24.50	36
		44.00	19.20	23.05	24.00	35
		44.00	18.70	22.55	23.50	34
		44.00	18.20	22.05	23.00	33
		44.00	17.70	21.55	22.50	32
		44.00	17.20	21.05	22.00	31
		32.00	16.70	20.55	21.50	30
		32.00	16.20	20.05	21.00	29
		32.00	15.70	19.55	20.50	28
		32.00	15.20	19.05	20.00	27
20000	2000	32.00	14.70	18.55	19.50	26
		32.00	14.20	18.05	19.00	25
		32.00	13.70	17.55	18.50	24
		32.00	13.20	17.05	18.00	23
		32.00	12.70	16.55	17.50	22
		32.00	12.20	16.05	17.00	21
		24.00	11.70	15.55	16.50	20
		24.00	11.20	15.05	16.00	19
		24.00	10.70	14.55	15.50	18
		24.00	10.20	14.05	15.00	17
		24.00	9.70	13.55	14.50	16
		24.00	9.20	13.05	14.00	15
		D	C	B	A	

THIS DRAWING IS A CONTROLLED DOCUMENT.

DIMENSIONS: MM	TOLERANCES UNLESS OTHERWISE SPECIFIED:	DWN	TE Connectivity			
0 PLC ± - 1 PLC ± - 2 PLC ± - 3 PLC ± - 4 PLC ± - ANGLES ± -		CHK	NAME			
MATERIAL	FINISH	APVD	FPC CONNECTOR, 0.5mm PITCH, BOTTOM CONTACT, SMT TYPE.			
		PRODUCT SPEC	SIZE	CAGE CODE	DRAWING NO	RESTRICTED TO
		APPLICATION SPEC	A3	00779	C=1734592	
		WEIGHT	CUSTOMER DRAWING		SCALE	SHEET 3 OF 3
					REV	C

## X-ON Electronics

Largest Supplier of Electrical and Electronic Components

*Click to view similar products for [FFC & FPC Connectors](#) category:*

*Click to view products by [TE Connectivity](#) manufacturer:*

Other Similar products are found below :

[FPH-1422G](#) [FPH-1602G](#) [K-FC20](#) [FH29B-80S-0.2SHW\(99\)](#) [FPH-2022G](#) [AYF332735](#) [52610-1075](#) [52610-1275](#) [52610-1934](#) [501864-3091-TR225](#) [086222026001800](#) [52610-0675](#) [62684-36210E9ALF](#) [52746-1671-TR250](#) [10051922-2810EHLF](#) [6-520415-9](#) [SFV6R-1STE9HLF](#) [XF3M-2915-1B-R100](#) [1658549-1](#) [AYF534065TA](#) [AYF351525](#) [086212040340800+](#) [AYF530365TA](#) [67000-014LF](#) [67000-004LF](#) [006207341915000+](#) [DS1020-19RT1D](#) [67000-003LF](#) [67000-011LF](#) [67000-016LF](#) [HFW14R-2STE9LF](#) [SFV32R-2STBE9HLF](#) [SFW12R-5STE9LF](#) [SFW18R-1STAE9LF](#) [SFW4R-5STE9LF](#) [52807-0430](#) [046283021002868+](#) [THD1015-8CL-SN](#) [67000-006LF](#) [502250-8027](#) [104267-9617](#) [66987-011LF](#) [AYF362535](#) [F0501-T-50-20T-R](#) [F1003-ZV-12-25T-R](#) [HFW8S-2STAE1HLF](#) [67000-008LF](#) [67000-012LF](#) [F1002-B-20-20T-R](#) [HFW15S-2STAE1HLF](#)