

NUMBER C-173985

METRIC

PRINT DIST

単位: 概 DIMENSIONS IN MM. DO NOT SCALE PRINT

4

3

2

1

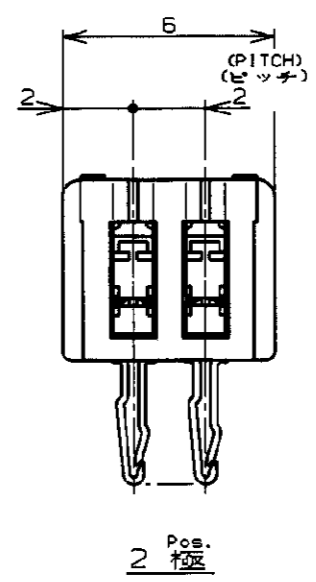
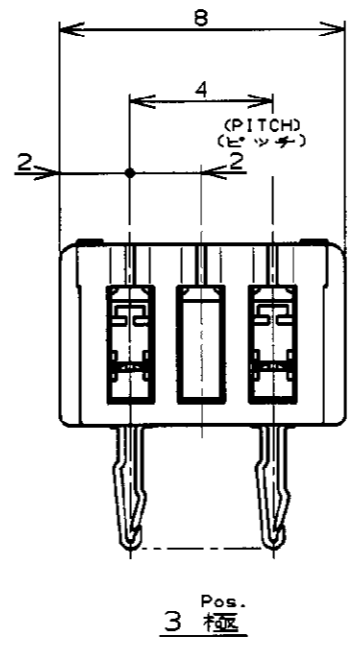
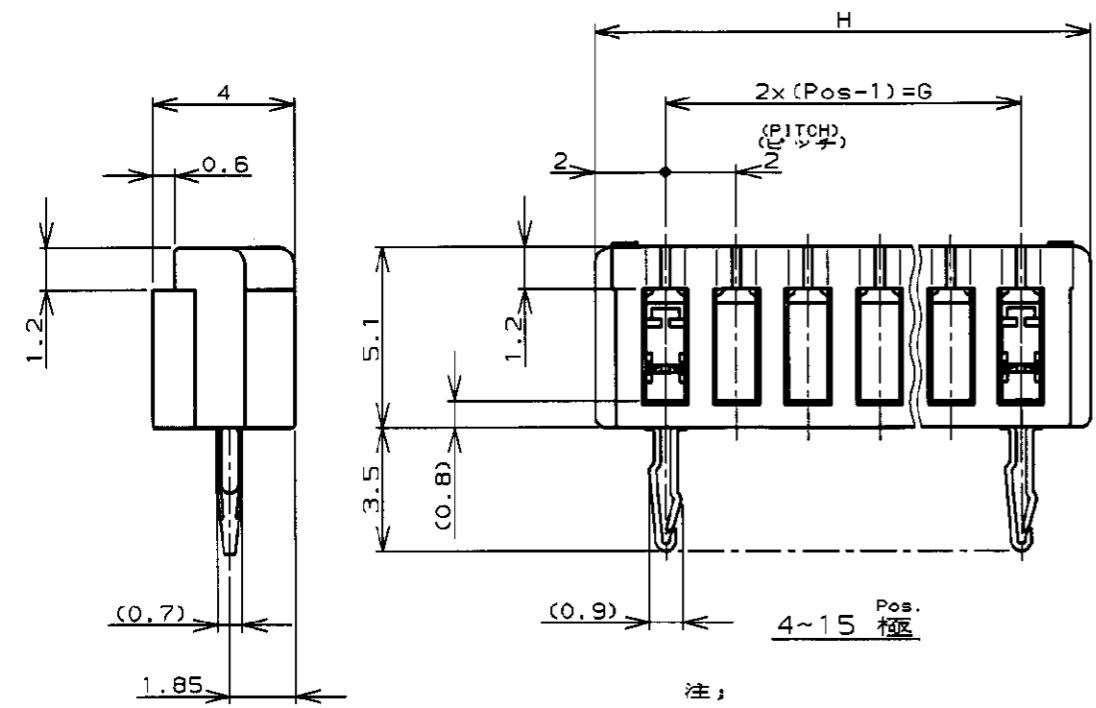
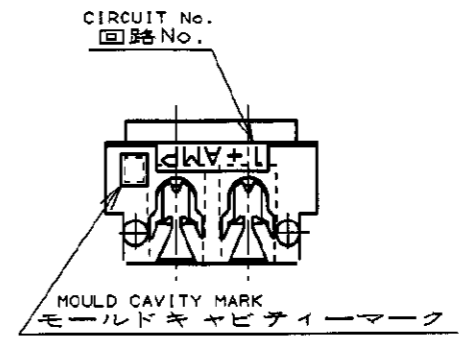
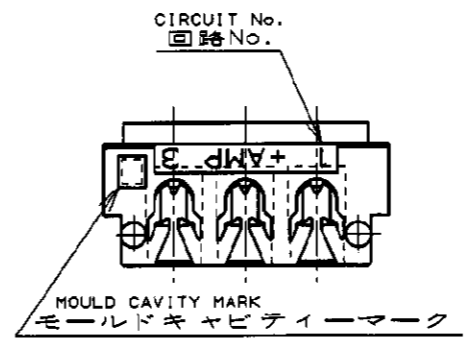
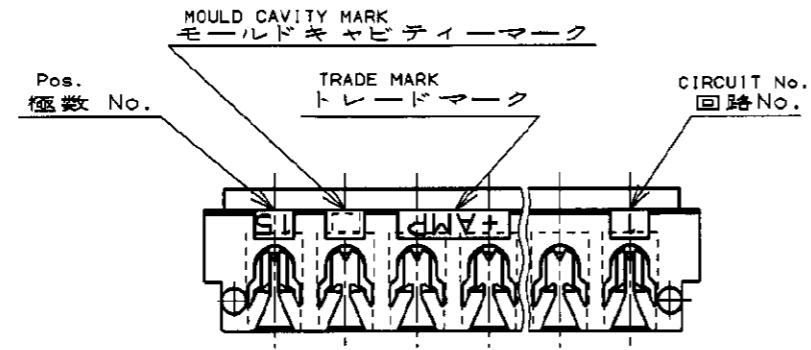

- 注;
1. 適用電線範囲 : AWG #28~26 (UL1571, UL1061)
被覆外径 : 0.83~10.5
(但し、使用電線について適合性に確認が必要です。)
 2. 材料 : ハウジング : ガラス入りP.B.T UL94V-0
コンタクト : 錫めつき済磷青銅
 3. 適用製品規格番号 : 108-5217
 4. 取付適用規格番号 : 114-5103

- NOTES;
1. APPLICABLE WIRE SIZE : AWG #28~26 (UL1571, UL1061)
INSULATION DIA RANGE : 0.83~1.05
 2. MATERIAL :
HOUSING : P.B.T. (G.F)UL94V-0
CONTACT : PRE-TIN PHOS BRONZE
 3. PRODUCT SPEC : 108-5217
 4. APPLICATION SPEC : 114-5103

3-173985-5	15	28	32
3-	-4	14	26 30
3-	-3	13	24 28
3-	-2	12	22 26
3-	-1	11	20 24
3-	-0	10	18 22
2-	-9	9	16 20
2-	-8	8	14 18
2-	-7	7	12 16
2-	-6	6	10 14
2-	-5	5	8 12
2-	-4	4	6 10
2-	-3	3	AS SHOWN 図示
2-173985-2	2	AS SHOWN 図示	
LIGHT BULB ライトフルー	Pos. 極数	G	H
PART No. 製品型番			

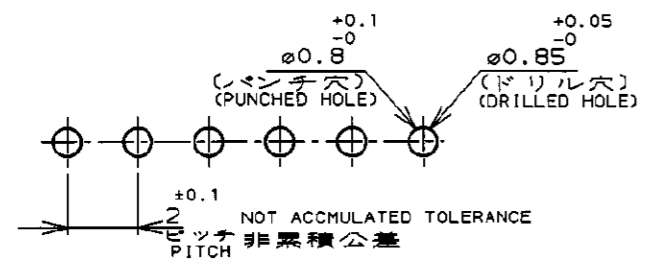

RECOMMENDABLE P.C. BOARD LAYOUT
推奨基板穴寸法
(適用基板厚0.8~1.6)
(P.C.B THK:0.8~1.6)

F1	REVISED PER ECO-11-005033	RK	HMR	2APR11
LTR	変更 (REVISION RECORD)	DR	CHK	DATE

		TE Connectivity	
組合電線断面積 (WIRE RANGE)	被覆外径 (INSULATION DIA.)	名称 (NAME)	
NOTE 1 mm ² (AWG -)	NOTE 1 mmφ	CT AMP-IN HEADER 2mm PITCH MT VERTICAL (V-TYPE)	
材料 (MATERIAL)	仕上 (FINISH)	一般公差 (GENERAL TOLERANCE)	
NOTE 2	— / —	10以下 : ±0.2 10を超え 30以下 : ±0.25 30を超え 100以下 : ±0.3 角 度 : ±3°	
DR. 23/AUG/99 J. TSUJI	DE. 23/AUG/99 J. Tsuji	LOC B J	番号 (No.) C-173985
CRK 23 AUG 99	APP. 23 AUG 99	尺度 (SCALE) 5-1	REV. F1 SHEET 1 OF 1

X-ON Electronics

Largest Supplier of Electrical and Electronic Components

Click to view similar products for [Headers & Wire Housings](#) category:

Click to view products by [TE Connectivity](#) manufacturer:

Other Similar products are found below :

[892-18-020-10-001101](#) [58102-G61-06LF](#) [582553-1](#) [0009485154](#) [009176003701906](#) [0050291907](#) [LY20-4P-DT1-P1E-BR](#) [02.125.8002.8](#)
[609-3404](#) [61062-3](#) [61082-181009](#) [622-3653LF](#) [63453-116](#) [636-1030](#) [636-1427](#) [636-3427](#) [636-4007](#) [641938-9](#) [641991-4](#) [644827-2](#) [65817-](#)
[010LF](#) [65817-015LF](#) [65863-015LF](#) [66207-023LF](#) [67095-007LF](#) [67601157](#) [68645-018](#) [68648-049](#) [70.362.1628.0](#) [70-4210](#) [70-4226B](#) [70-](#)
[4853B](#) [707-5020](#) [707-5028](#) [71.350.2428.0](#) [71918-208LF](#) [71961-016LF](#) [733-134](#) [733-162](#) [754199-000](#) [760-3052](#) [79531-3000](#) [FCN-](#)
[360C032-B](#) [FCN-367T-T012/H](#) [FCN-723D010/2](#) [80.063.4001.1](#) [800-90-010-10-002000](#) [801-43-002-10-013000](#) [801-43-006-10-002000](#)
[801-93-011-10-001000](#)