

Type EP Series

Key Features

- Power up to 10W in Small Size
- 16 Size / Power Options
- Specially Designed and Tested for Surge Immunity
- Flame Resistant Coating

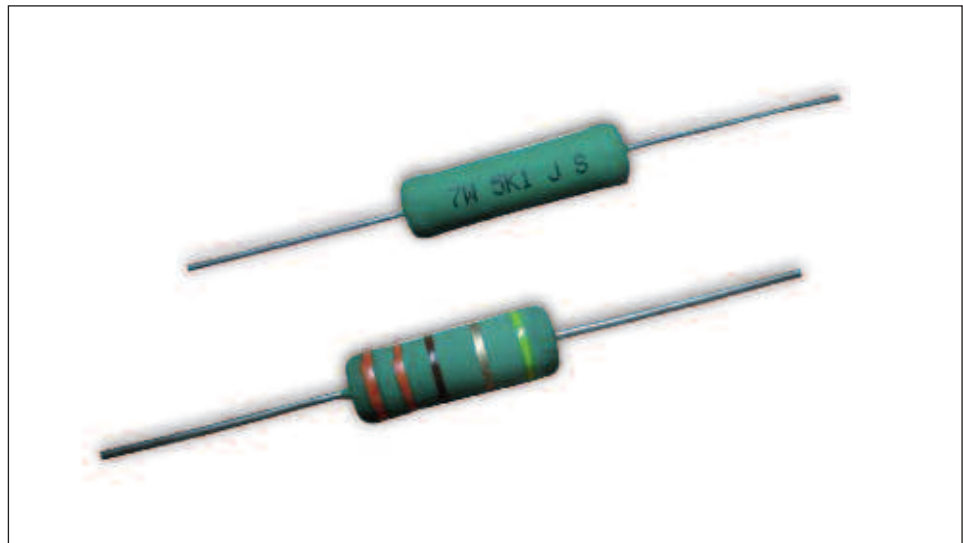

TE Connectivity is pleased to offer this wire wound axial leaded resistor. Robustly manufactured with high quality materials this resistor offers flame proof coating, and is designed and tested to withstand power surges of up to 12KV.

Characteristics – Electrical

| | Type | Rated Power at 70° C | Max. Working Voltage | Max. Overload Voltage | Dielectric Withstanding Voltage | Resistance Range | Operating Temp. Range |
|-------------|------------|----------------------|----------------------|-----------------------|---------------------------------|------------------|-----------------------|
| Normal size | EP05W | 1/2W (0.50W) | 500 V | 1,000 V | 350 V | 10Ω–560Ω | -55°C – +155°C |
| | EP1W | 1W | 500 V | 1,000 V | 500 V | 10Ω–1KΩ | |
| | EP2W | 2W | 500 V | 1,000 V | 500 V | 10Ω–2KΩ | |
| | EP3W | 3W | 500 V | 1,000 V | 500 V | 10Ω–3KΩ | |
| | EP5W | 5W | 500 V | 1,000 V | 500 V | 10Ω–5KΩ | |
| | EP7W | 7W | 500 V | 1,000 V | 500 V | 10Ω–6KΩ | |
| | EP8W | 8W | 500 V | 1,000 V | 500 V | 10Ω–10KΩ | |
| | EP9W | 9W | 500 V | 1,000 V | 500 V | 10Ω–15KΩ | |
| | Small size | EP1WS | 1W | 500 V | 1,000 V | 500 V | |
| EP2WS | | 2W | 500 V | 1,000 V | 500 V | 10Ω–1KΩ | |
| EP3WS | | 3W | 500 V | 1,000 V | 500 V | 10Ω–2KΩ | |
| EP5WS | | 5W | 500 V | 1,000 V | 500 V | 10Ω–3KΩ | |
| EP7WS | | 7W | 500 V | 1,000 V | 500 V | 10Ω–5KΩ | |
| EP8WS | | 8W | 500 V | 1,000 V | 500 V | 10Ω–6KΩ | |
| EP9WS | | 9W | 500 V | 1,000 V | 500 V | 10Ω–10KΩ | |
| EP10WS | | 10W | 500 V | 1,000 V | 500 V | 10Ω–15KΩ | |

Power Derating Curve

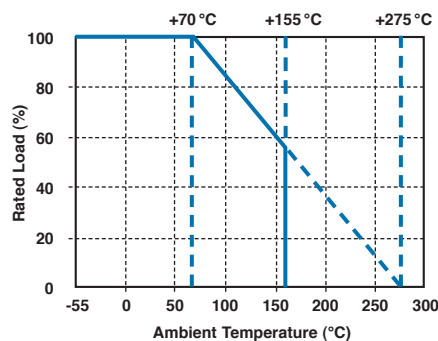

For resistors operated in ambient temperatures above 70°C, power rating must be derated in accordance with this curve.

Type EP Series

Surge Rating

| Type | Low Resistance Range | Maximum Surge Voltage | Medium Resistance Range | Maximum Surge Voltage | High Resistance Range | Maximum Surge Voltage |
|-------------------|----------------------|-----------------------|-------------------------|-----------------------|-----------------------|-----------------------|
| EP05W | 10Ω – 40Ω | 3KV | 43Ω – 240Ω | 4kV | 270Ω – 560Ω | 4kV |
| EP1W | 10Ω – 50Ω | 4KV | 51Ω – 240 Ω | 5kV | 270Ω – 1kΩ | 5kV |
| EP2W | 10Ω – 100Ω | 5KV | 110Ω – 240Ω | 6kV | 270Ω – 2kΩ | 6kV |
| EP3W | 10Ω – 100Ω | 7KV | 110Ω – 680Ω | 8kV | 750Ω – 3kΩ | 8kV |
| EP5W | 10Ω – 160Ω | 8KV | 180Ω – 680Ω | 9kV | 750Ω – 5kΩ | 9kV |
| EP7W | 10Ω – 160Ω | 9KV | 180Ω – 680Ω | 10kV | 750Ω – 6kΩ | 10kV |
| EP8W | 10Ω – 160Ω | 10KV | 180Ω – 680Ω | 11kV | 750Ω – 10kΩ | 11kV |
| EP9W | 10Ω – 160Ω | 10KV | 180Ω – 680Ω | 11kV | 750Ω – 15kΩ | 12kV |
| Small Size | | | | | | |
| EP1WS | 10Ω – 40Ω | 3KV | 43Ω – 240Ω | 4kV | 270Ω – 560Ω | 4kV |
| EP2WS | 10Ω – 50Ω | 4KV | 51Ω – 240 Ω | 5kV | 270Ω – 1kΩ | 5kV |
| EP3WS | 10Ω – 100Ω | 5KV | 110Ω – 240Ω | 6kV | 270Ω – 2kΩ | 6kV |
| EP5WS | 10Ω – 100Ω | 7KV | 110Ω – 680Ω | 8kV | 750Ω – 3kΩ | 8kV |
| EP7WS | 10Ω – 160Ω | 8KV | 180Ω – 680Ω | 9kV | 750Ω – 5kΩ | 9kV |
| EP8WS | 10Ω – 160Ω | 9KV | 180Ω – 680Ω | 10kV | 750Ω – 6kΩ | 10kV |
| EP9WS | 10Ω – 160Ω | 10KV | 180Ω – 680Ω | 11kV | 750Ω – 10kΩ | 11kV |
| EP10WS | 10Ω – 160Ω | 10KV | 180Ω – 680Ω | 11kV | 750Ω – 15kΩ | 12kV |

Surge Waveform (1.2/50 μs)

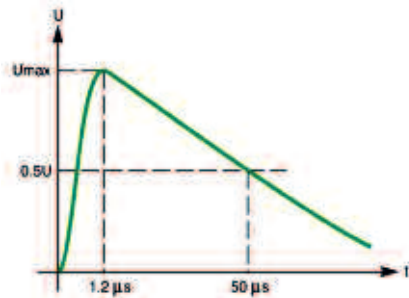

1.2/50 μs Voltage Capability

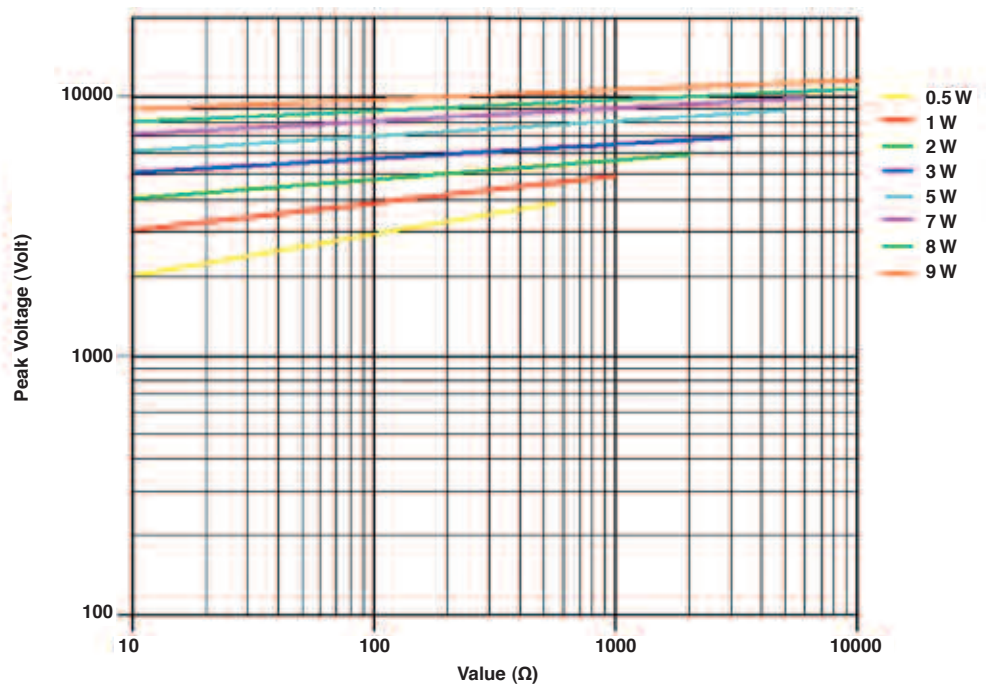

Type EP Series

Construction

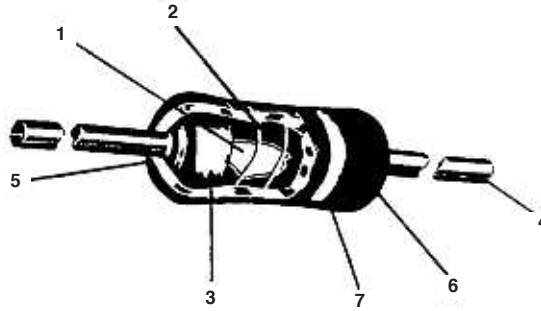

| No. | Name | Material |
|-----|-----------------|--|
| 1 | Basic Body | Rod Type Ceramics |
| 2 | Resistance Wire | Ni-Cr Alloy, Cu-Ni Alloy |
| 3 | End Cap | Steel (Tin plated iron surface) |
| 4 | Lead Wire | Annealed copper wire coated with tin |
| 5 | Joint | By welding |
| 6 | Coating | Insulated & Non-Flame paint (Color: Light Green) |
| 7 | Color Code | Non-Flame epoxy resin |

Dimensions



| Part No. | Power Rating at 70 °C | Dimension (mm) | | | |
|----------|--------------------------|----------------|-------|----------|-------|
| | | D ± 1 | L ± 1 | d ± 0.05 | H ± 3 |
| EP05W | 1/2W (0.50W) | 3.5 | 10.0 | 0.54 | 28 |
| EP1W | 1W | 5.0 | 12.0 | 0.70 | 25 |
| EP2W | 2W | 5.5 | 16.0 | 0.70 | 28 |
| EP3W | 3W | 6.5 | 17.5 | 0.75 | 28 |
| EP5W | 5W | 8.5 | 25.0 | 0.75 | 38 |
| EP7W | 7W | 8.5 | 30.0 | 0.75 | 38 |
| EP8W | 8W | 8.5 | 40.0 | 0.75 | 38 |
| EP9W | 9W | 8.5 | 53.0 | 0.75 | 38 |
| EP1WS | 1W-S | 3.5 | 10.0 | 0.54 | 28 |
| EP2WS | 2W-S | 5.0 | 12.0 | 0.70 | 25 |
| EP3WS | 3W-S | 5.5 | 16.0 | 0.70 | 28 |
| EP5WS | 5W-S | 6.5 | 17.5 | 0.75 | 28 |
| EP7WS | 7W-S | 8.5 | 25.0 | 0.75 | 38 |
| EP8WS | 8W-S | 8.5 | 30.0 | 0.75 | 38 |
| EP9WS | 9W-S | 8.5 | 40.0 | 0.75 | 38 |
| EP10WS | 10W-S | 8.5 | 53.0 | 0.75 | 38 |

Type EP Series

Characteristics – Environmental

| Item | Limits | Test Method (JIS C 5201-1) |
|--|---|---|
| Temperature Coefficient of Resistance (TCR): | <20Ω : ±400PPM/°C ≥20Ω : ±300PPM/°C | R2-R1 R1 (t2-t1) x 10 ⁶ (PPM/°C) |
| Short Time Overload: | ± (2% + 0.05Ω) Max | RCWV*2.5 for 5 seconds |
| Load Life: | ±(5.0%+0.05Ω) | 70±2°C Max. working voltage for 1000 hrs with 1.5 hrs "ON" and 0.5 hrs "OFF" |
| Load Life in Humidity: | ±(5.0%+0.05Ω) | 40±2°C, 90-95% R.H. Max working voltage for 1000 hrs with 1.5hrs hrs "ON" and 0.5 hrs "OFF" |
| Solderability: | 95% min. coverage | 245±5°C for 3 seconds |
| Resistance to Soldering Heat: | ±(1.0%+0.05Ω) | Leads immersed 3.2 – 4.8 mm from body - 350±10°C for 3±0.05 seconds |
| Resistance to Solvent: | No deterioration of protective coating and markings | Immersed in trichroethane bath for 3 minutes with ultrasonic |
| Surge Immunity Test: | ±(5% + 0.05Ω) Max. | Refer to IEC61000-4-5 |
| | | Max Surge Voltage |
| | | 1/2W 1WS 4KV |
| | | 1W 2WS 5KV |
| | | 2W 3WS 6KV |
| | | 3W 5WS 8KV |
| | | 5W 7WS 9KV |
| | | 7W 8WS 10KV |
| | | 8W 9WS 11KV |
| | | 9W 10WS 12KV |



1.2 μsec rising time and 50 μsec discharge; every 1 minute for 10 cycle

Storage Temperature: 25±3°C; Humidity 60% RH ±10%

Marking

For EP Normal Size 1/2W, 1W, 2W, 3W and EP Small Size 1WS, 2WS, 3WS, 5WS Resistors shall be marked with color coding in accordance with JIS C 0802.

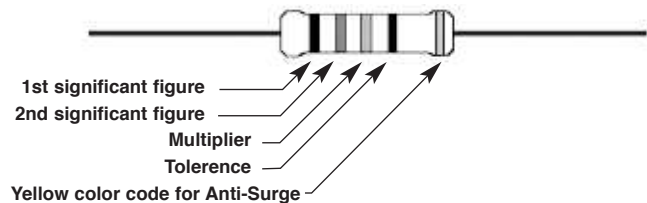

For EP Normal Size 5W, 7W, 8W 9W and EP Small Size 7WS, 8WS, 9WS, 10WS Resistors will be marked with power rating, nominal resistance and resistance tolerance code.

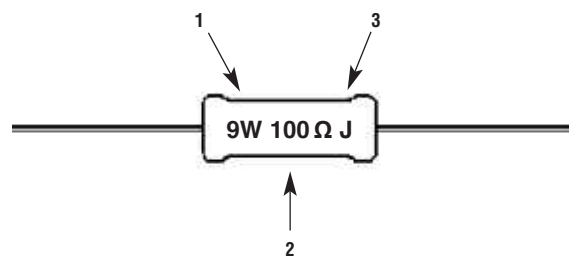

Type EP Series

Packaging

EP Normal Size: 1/2W, 1W, 2W, 3W and EP Small Size 1WS, 2WS, 3WS, 5WS supplied taped in "ammo boxes". All larger sizes supplied bulk packed in boxes

How to Order

| EP Common Part | 3W Power rating | 200R Nominal Resistance | J Resistance Tolerance |
|-------------------|---|--------------------------------------|---|
| EP | 05W = 1/2W 1W = 1W 1WS = 1WS As per Electrical characteristics chart | 10Ω – 10R 1KΩ -1K0 (1000Ω) | F = ±1% G = ±2% J = ±5% K = ±10% |

TE Connectivity, TE connectivity (logo) and TE (logo) are trademarks.
Other logos, product and Company names mentioned herein may be trademarks of their respective owners.

While TE has made every reasonable effort to ensure the accuracy of the information in this datasheet, TE does not guarantee that it is error-free, nor does TE make any other representation, warranty or guarantee that the information is accurate, correct, reliable or current. TE reserves the right to make any adjustments to the information contained herein at any time without notice. TE expressly disclaims all implied warranties regarding the information contained herein, including, but not limited to, any implied warranties of merchantability or fitness for a particular purpose. The dimensions in this datasheet are for reference purposes only and are subject to change without notice. Specifications are subject to change without notice. Consult TE for the latest dimensions and design specifications.

X-ON Electronics

Largest Supplier of Electrical and Electronic Components

Click to view similar products for [Wirewound Resistors - Through Hole](#) category:

Click to view products by [TE Connectivity](#) manufacturer:

Other Similar products are found below :

[75822-2K4](#) [90J56R](#) [PW10-39R-5%](#) [ALSR1-20](#) [EP3WS47RJ](#) [RWR81S1000BRB12](#) [RWR81S12R4FRB12](#) [RWR81SR511FRB12](#)
[RWR81SR619FRBSL](#) [RWR89S10R0FRB12](#) [RWR89S9310FPB12](#) [27J1K0](#) [93J62RE](#) [AC10000002208JAB00](#) [1HJ-25](#) [FSQ5WR47J](#)
[FW10A33R0JA](#) [25J39K](#) [25J5R0-B](#) [25W1D0](#) [272-303-JBW](#) [280-PRM5-150-RC](#) [CP0005270R0JE1491](#) [CPCC0510R00JE32](#)
[CPCC051R000JB31](#) [CPW052K500JE143](#) [CPW05700R0JE143](#) [C1010RJL](#) [CA000210R00JE14](#) [VPR5F1500](#) [RS02B887R0FE73](#)
[RWR74SR604FRB12](#) [RWR84S1001FRB12](#) [RWR84S20R0FSBSL](#) [RWR89S6190FSB12](#) [CPW055R000JB143](#) [ULW5-39R0JT075](#) [W31-](#)
[R047JA1](#) [VP25K-120](#) [VC3D900](#) [ULW5-68RJT075](#) [65888-3R3](#) [CB5JB10R0](#) [CPW151K500JE313](#) [RWR80N3400FSB12](#)
[RWR81S1000FRB12](#) [RWR81S1000FSB12](#) [RWR89S6R81FRB12](#) [RWR89N30R1FRB12](#) [RWR81S4R99FPB12](#)