

Type CRGCQ Series

Key Features

Small size and light weight

Suitable for both wave and reflow soldering techniques

Supplied on tape

AEC-Q200 Compliant

7 different package sizes

Terminal finish matte Sn over Ni



TE Connectivity is pleased to introduce our AEC-Q200 compliant thick film Chip resistor, suitable for auto placement in volume and for most applications.

Available in seven different packages and supplied on tape and reel for automatic insertion processes. Standard values – E24 Series

Characteristics – Electrical

Type	CRGCQ0402	CRGCQ0603	CRGCQ0805	CRGCQ1206
Power Rating @ 70°C	0.0625W	0.1W	0.125W	0.25W
Jumper Rated current	1A	1A	2A	2A
Max. Jumper Current	2A	2A	5A	10A
Max. Working Voltage	50V	75V	150V	200V
Max. Overload Voltage	100V	150V	300V	400V
Dielectric Withstand V.	100V	300V	500V	500V
Jumper resistance	<50mΩ			
Temperature Range	-55°C ~ +155°C			
Ambient Temperature	70°C			

Type	CRGCQ1210	CRGCQ2010	CRGCQ2512
Power Rating @ 70°C	0.5W	0.75W	1W
Jumper Rated current	2A	2A	2A
Max. Jumper Current	10A	10A	10A
Max. Working Voltage	200V	200V	200V
Max. Overload Voltage	500V	500V	500V
Dielectric Withstand V.	500V	500V	500V
Jumper resistance	<50mΩ		
Temperature Range	-55°C ~ +155°C		
Ambient Temperature	70°C		

Power derating curve

Power rating based on continuous load operation in ambient temperature of 70°C. For resistors operated in ambient temperatures above 70°C, power rating must be derated in accordance with this curve.

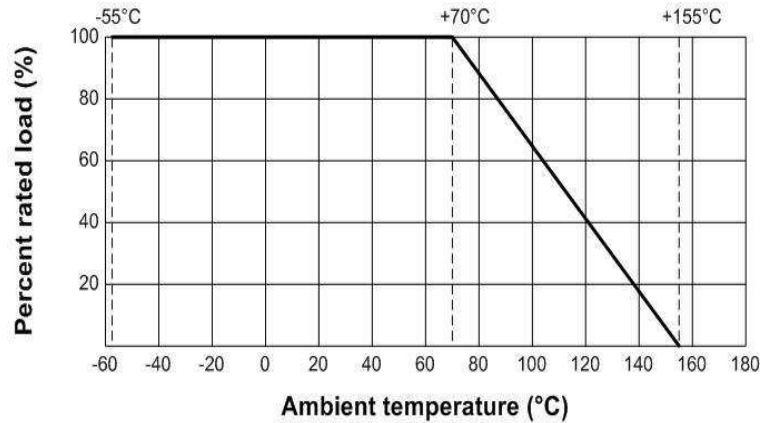

Dimensions:

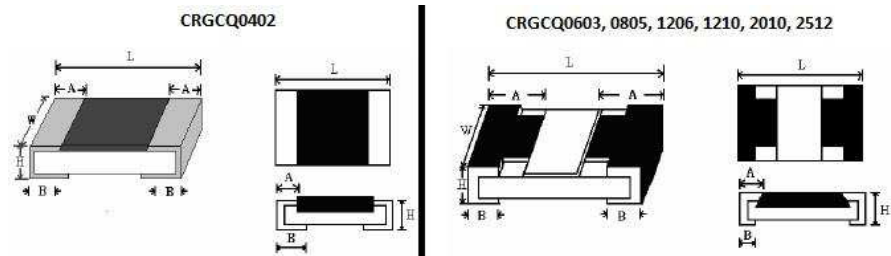

Type	Dimension (mm)				
	L	W	H	A	B
CRGCQ0402	1.00±0.10	0.50±0.05	0.35±0.05	0.20±0.10	0.25±0.10
CRGCQ0603	1.60±0.10	0.80±0.10	0.45±0.10	0.30±0.20	0.30±0.20
CRGCQ0805	2.00±0.15	1.25+0.15 -0.10	0.55±0.10	0.40±0.20	0.40±0.20
CRGCQ1206	3.10±0.15	1.55+0.15 -0.10	0.55±0.10	0.45±0.20	0.45±0.20
CRGCQ1210	3.10±0.10	2.60±0.20	0.55±0.10	0.50±0.25	0.50±0.20
CRGCQ2010	5.00±0.10	2.50±0.20	0.55±0.10	0.60±0.25	0.50±0.20
CRGCQ2512	6.35±0.10	3.20±0.20	0.55±0.10	0.60±0.25	0.50±0.20

Construction:

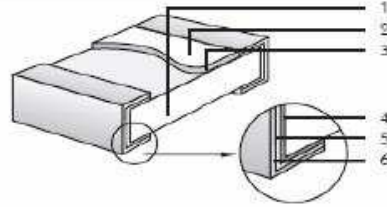

1. High purity alumina substrate
2. Protective coating
3. Resistive element
4. Termination (inner) Ni/Cr
5. Termination (between) Ni Barrier
6. Termination (outer) Sn

Power Rating and Resistance Range:

Type	Power Rating @ 70°C	Tolerance	Resistance Range	Standard Series
CRGCQ0402	0.0625W	Jumper	< 50mΩ	E24 E96 by negotiation
		±1%	10R – 1M	
		±5%	1R0 – 10M	
CRGCQ0603	0.1W	Jumper	< 50mΩ	E24 E96 by negotiation
		±1%	10R – 1M	
		±5%	1R0 – 10M	
CRGCQ0805	0.125W	Jumper	< 50mΩ	E24 E96 by negotiation
		±1%	10R – 1M	
		±5%	1R0 – 10M	
CRGCQ1206	0.25W	Jumper	< 50mΩ	E24 E96 by negotiation
		±1%	10R – 1M	
		±5%	1R0 – 10M	
CRGCQ1210	0.5W	Jumper	< 50mΩ	E24 E96 by negotiation
		±1%	10R – 1M	
		±5%	1R0 – 10M	
CRGCQ2010	0.75W	Jumper	< 50mΩ	E24 E96 by negotiation
		±1%	10R – 1M	
		±5%	1R0 – 10M	
CRGCQ2512	1W	Jumper	< 50mΩ	E24 E96 by negotiation
		±1%	10R – 1M	
		±5%	1R0 – 10M	

Marking:

E24 series 0603 – 2512 3 Digits – first two digits denote significant figures of resistance and third digit denotes number of zeros thereafter. EG

	22	
--	----	--

 =
 2K2

Marking for E96 Series 0805 – 2512 4 digits – First three digits denote significant figures of resistance and fourth digit denotes number of zeros thereafter. EG.

	100	
--	-----	--

 =
 100R

For ohmic values below 100R letter “R” denotes decimal point. EG

	1R8	
--	-----	--

 =
 1R8 / 1.8Ω

0402 size chips are not marked

0603 E96 3 digit marking.

Mutiplier Code :

Code	A	B	C	D	E	F	G	H	X	Y	Z
Multiplier	⁰ 10	¹ 10	² 10	³ 10	⁴ 10	⁵ 10	⁶ 10	⁷ 10	⁻¹ 10	⁻² 10	⁻³ 10

Coding



Resistance Code

Formula



Multiplier Code

Example : $10.2K\Omega = \begin{matrix} 102 \\ \downarrow \\ 02 \end{matrix} X \begin{matrix} 10 \\ \downarrow \\ C \end{matrix} \Omega = 02C$

$33.2\Omega = \begin{matrix} 332 \\ \downarrow \\ 31 \end{matrix} X \begin{matrix} 10 \\ \downarrow \\ X \end{matrix} \Omega = 51X$

Value	Code	Value	Code	Value	Code	Value	Code	Value	Code
100	01	162	21	261	41	422	61	681	81
102	02	165	22	267	42	432	62	698	82
105	03	169	23	274	43	442	63	715	83
107	04	174	24	280	44	453	64	732	84
110	05	178	25	287	45	464	65	750	85
113	06	182	26	294	46	475	66	768	86
115	07	187	27	301	47	487	67	787	87
118	08	191	28	309	48	499	68	806	88
121	09	196	29	316	49	511	69	825	89
124	10	200	30	324	50	523	70	845	90
127	11	205	31	332	51	536	71	866	91
130	12	210	32	340	52	549	72	887	92
133	13	215	33	348	53	562	73	909	93
137	14	221	34	357	54	576	74	931	94
140	15	226	35	365	55	590	75	953	95
143	16	232	36	374	56	604	76	976	96
147	17	237	37	383	57	619	77		
150	18	243	38	392	58	634	78		
154	19	249	39	402	59	649	79		
158	20	255	40	412	60	665	80		

- Marking for E96 series 0603 size with no marking code marked as per E24 values.

Performance Specification

Characteristics	Limits	Test Methods
Load life	±1%: ±(1.0%+0.1Ω)Max. ±5%: ±(3.0%+0.1Ω)Max.	125°C, 35% power, at RCWV or Max. Working Voltage whichever less, 1,000 hours (1.5 hours “ON”, 0.5hours“OFF”), Measurement at 24±2 hours after test conclusion. (MIL-STD-202 Method 108)
Temperature coefficient	1Ω ≤ R ≤ 10Ω: ±400PPM/°C 10Ω < R ≤ 100Ω: ±200PPM/°C R > 100Ω: ±100PPM/°C	Measure between -55°C ~ +125°C
Short-time overload	±1%: ±(1.0%+0.1Ω) Max ±5%: ±(2.0%+0.1Ω) Max	2.5x Rated voltage or Max. Overload Voltage whichever is lower for 5 seconds, then check the resistance.
Terminal Bending	±(1.0%+0.05Ω) Max	Bending Distance 3mm, Duration: 60s±5s, then check the resistance
Solderability	95% coverage Min.	245±3°C; 2~3s
Soldering heat	±(1.0%+0.05Ω) Max	260±5°C; 10±1s
Moisture Resistance	1%: ± (0.5%+0.1Ω) Max. 5%: ± (3.0%+0.1Ω) Max.	25°C~65°C, 90~100%RH, 2.5Hr; 65°C 90~100%RH, 3Hr; 65°C~25°C 80~100%RH, 2.5Hr, 10 cycles, Measurement at 24 hours after test conclusion (MIL-STD-202 Method 106)
Biased Humidity	1%: ± (1.0%+0.1Ω) Max. 5%: ± (3.0%+0.1Ω) Max.	10% rated power, 85°C/85%RH, 1000Hr. Measurement at 24 hours after test conclusion. (MIL-STD-202 Method 103)
Dielectric Withstand Voltage	No evidence of flashover, mechanical damage, arcing or insulation breakdown	Resistor shall be clamped in the trough of 90° metallic V-block and shall be tested at AC potential respectively specified in the given list of each product type for 60~70s.
Temperature cycling	1%: ± (0.5%+0.1Ω) Max. 5%: ± (1.0%+0.1Ω) Max	-55±3°C 30min ~normal temperature 10min-15min~155±2°C 30min~normal temperature 10min-15min1000 cycles. Measurement at 24 hours after test conclusion. (JESD22 Method JA-104)
ESD	±(1.0%+0.05Ω) Max	With the electrometer in direct contact with the discharge tip, verify the voltage setting at levels of ±500V, ±1KV, ±2KV, ±4KV, ±8KV, The electrometer reading shall be within ±10% for voltages from 500V to ≤800V. (AEC-Q200-002)
Sulfuration test	1%: ± (1.0%+0.1Ω) Max. 5%: ± (5.0%+0.1Ω) Max.	H2S 3~5PPM 50°C±2°C 91%~93% RH 1000H

Packaging Specification

Paper taping

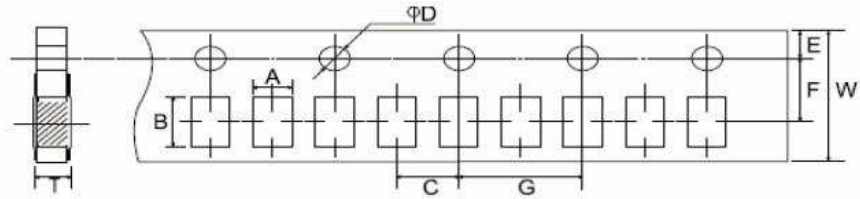

Type	A ±	B ±	C ±	ØD +0.1 -0	E ±	F ±	G ±	W ±	T ±
0402	0.65	1.15	2.0	1.5	1.75	3.5	4.0	8.0	0.45
0603	1.10	1.90	2.0	1.5	1.75	3.5	4.0	8.0	0.67
0805	1.65	2.40	2.0	1.5	1.75	3.5	4.0	8.0	0.81
1206	2.00	3.60	2.0	1.5	1.75	3.5	4.0	8.0	0.81
1210	2.80	3.50	2.0	1.5	1.75	3.5	4.0	8.0	0.75
2010	2.80	5.40	2.0	1.5	1.75	5.5	4.0	12.0	0.75

Embossed Taping

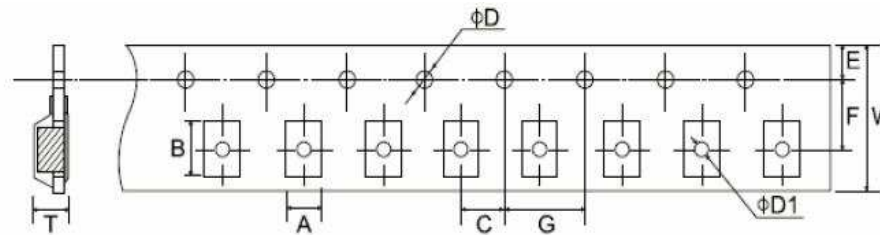

Type	A ±	B ±	C ±	ØD +0.1 -0	ØD1 +0.1 -0	E ±	F ±	G ±	W ±	T ±
2512	3.50	6.70	2.0	1.5	1.5	1.75	5.5	4.0	12.0	1.0

Peeling strength of cover tape:

Test condition: 0.1 to 0.7 N at a peel off speed of 300mm / min.

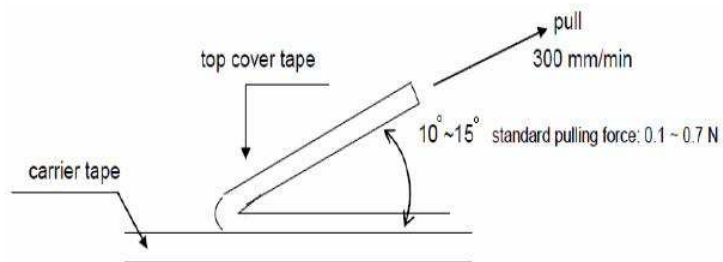

Reel Dimensions (mm):

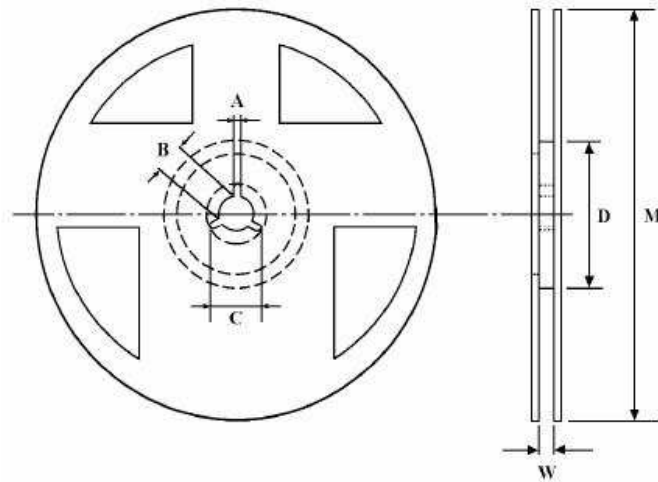

Type	Tape	Reel Qty	A ± 0.5	B ± 0.5	C ± 0.5	D ± 1	M ± 2	W ± 1
0402	Paper	10,000	2	13	21	60	178	10
0603	Paper	5,000	2	13	21	60	178	10
0805	Paper	5,000	2	13	21	60	178	10
1206	Paper	5,000	2	13	21	60	178	10
1210	Paper	5,000	2	13	21	60	178	10
2010	Paper	4,000	2	13	21	60	178	13.8
2512	Embossed	4,000	2	13	21	60	178	13.8

Label:

- A. TE Product Number
- B. Product Description
- C. Quantity
- D. Lot Number
- E. RoHS Statement

Example:

TYCO Pn	CRGCQ0603F100R	
DESC	CRGCQ 0603 100R 1%	
QTY	5000 Pcs.	PPM:
LOT	SAMPLE	
REF	RoHS 2011/65/EU	
		

Environment Related Substance

This product complies to EU RoHS directive, EU PAHs directive, EU PFOS directive and Halogen free.

Ozone layer depleting substances.

Ozone depleting substances are not used in our manufacturing process of this product.

This product is not manufactured using Chloro fluorocarbons (CFCs), Hydrochlorofluorocarbons (HCFCs), Hydrobromofluorocarbons (HBFCs) or other ozone depleting substances in any phase of the manufacturing process.

Storage Condition

The performance of these products, including the solderability, is guaranteed for a year from the date of arrival at your company, provided that they remain packed as they were when delivered and stored at a temperature of $25^{\circ}\text{C} \pm 10^{\circ}\text{C}$ and a relative humidity of $60\%RH \pm 10\%RH$, chemical and dust free atmosphere

Even within the above guarantee periods, do not store these products in the following conditions otherwise, their electrical performance and/or solderability may be deteriorated, and the packaging materials (e.g. taping materials) may be deformed or deteriorated, resulting in mounting failures.

1. In salty air or in air with a high concentration of corrosive gas, such as Cl_2 , H_2S , NH_3 , SO_2 , or NO_2
2. In direct sunlight

Solder Profile

Wave soldering condition: (2 cycles Max.)

Pre-heat : $100 \sim 120^{\circ}\text{C}$, 30 ± 5 sec.

Peak temp.: 260°C

Reflow soldering condition: (2 cycles Max.)

Pre-heat : 150 ~ 180 °C, 90 ~ 120 sec.

Suggestion solder temp.: 235 ~ 255 °C, 20 ~ 40 sec.

Peak temp.: 260 °C

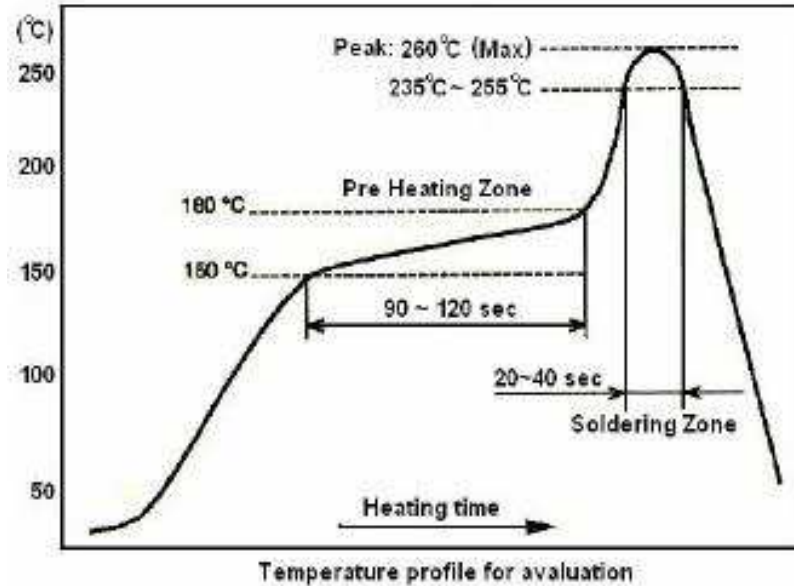

Hand Soldering condition: The Soldering iron tip should be less than 300°C and maximum contact time should be 5 seconds

How To Order

CRGCQ	0603	J	10K
Common Part	Size	Tolerance	Resistance Value
CRGCQ – AEC-Q200 compliant Thick Film Chip Resistor	0402	F - ±1% J - ±5%	1 ohm (1Ω) 1R0
	0603		1K ohm (1000Ω) 1K0
	0805		100K ohm (100000Ω)
	1206		100K
	1210		
	2010		
2512		1M ohm (1000000Ω) 1M0	

X-ON Electronics

Largest Supplier of Electrical and Electronic Components

Click to view similar products for [Thick Film Resistors - SMD category:](#)

Click to view products by [TE Connectivity manufacturer:](#)

Other Similar products are found below :

[CR-05FL7--19K6](#) [CR-05FL7--243R](#) [CR-05FL7--40K2](#) [CR-12JP4--680R](#) [M55342K03B499DRS6](#) [M55342K06B10D0RS6](#)
[M55342K06B14E0RS6](#) [M55342K06B16E2RS2](#) [M55342K06B24E9RS6](#) [M55342K06B309DRS3](#) [M55342K06B6E81RS3](#)
[M55342K08B100DRWB](#) [M55342M06B26E7RS3](#) [MC0603-511-JTW](#) [742C083750JTR](#) [MCR01MZPF1202](#) [MCR01MZPF1601](#)
[MCR01MZPF1800](#) [MCR01MZPF4992](#) [MCR01MZPF6201](#) [MCR01MZPF9102](#) [MCR01MZPJ113](#) [MCR01MZPJ121](#) [MCR01MZPJ125](#)
[MCR01MZPJ203](#) [MCR01MZPJ751](#) [MCR01MZPJ822](#) [MCR03EZHJ103](#) [MCR03EZPFX1272](#) [MCR03EZPFX2004](#) [MCR03EZPJ123](#)
[MCR03EZPJ270](#) [MCR03EZPJ821](#) [MCR10EZPF1102](#) [MCR10EZPF2003](#) [MCR10EZPF2700](#) [MCR18EZPJ101](#) [MCR18EZPJ330](#)
[RC0603F1473CS](#) [RC0603F150CS](#) [RC1005F1152CS](#) [RC1005F1182CS](#) [RC1005F1372CS](#) [RC1005F183CS](#) [RC1005F1911CS](#)
[RC1005F1912CS](#) [RC1005F201CS](#) [RC1005F203CS](#) [RC1005F2052CS](#) [RC1005F241CS](#)