

REVISIONS					
P	LTR	DESCRIPTION	DATE	DWN	APVD
G1		ECR-19-013959	06SEP2019	A.L	H.L

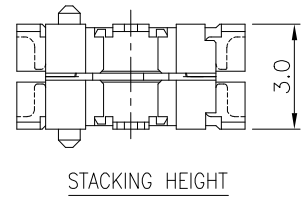

- NOTES:
- MATERIAL:
    - 1.1 HOUSING: PA6T, UL94V-0; COLOR: NATURAL.
    - 1.2 CONTACTS: PHOSPHOR BRONZE.
    - 1.3 PEGS: BRASS.
  - FINISH:
    - CONTACTS: (SEE TABLE)
    - PLATING B : GOLD FLASH ON ENTIRE CONTACT.
    - PLATING C : 100μ" MIN. MATTE-TIN ON ENTIRE CONTACT. (WITH ENTIRE CONTACT UNDERPLATED 50μ" MIN. NICKEL.)
    - PEGS: 100μ" MIN. TIN OR MATTE-TIN OVER 50μ" MIN. NICKEL.
  - PART NUMBER OF MATING RECEPTACLE: X-1775013-X
  - REFLOW SOLDER CAPABLE TO 260°C AS PER TEC-109-201, CONDITION B.
  - SUBSTANCE RESTRICTIONS FOR LOW HALOGEN (BY WEIGHT):
    - BROMINE (Br) ≤ 900 PPM (0.09%)
    - CHLORINE (Cl) ≤ 900 PPM (0.09%)
    - TOTAL CONCENTRATION OF (Cl) + (Br) ≤ 1500 PPM (0.15%)

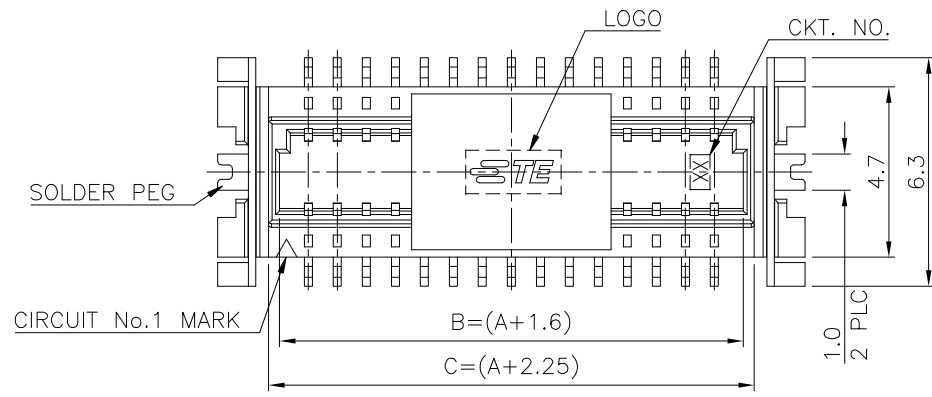
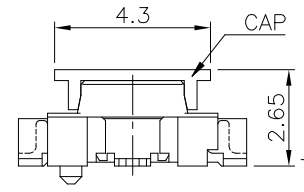
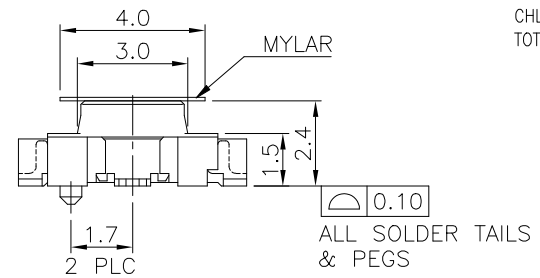
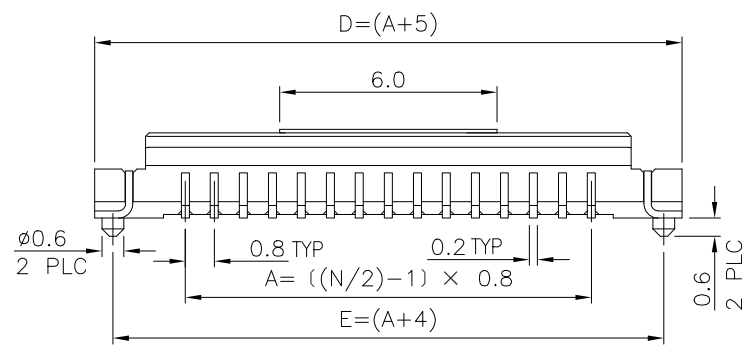

(1775014-1 & 5-1775014-4 ARE OBSOLETE)

CAP OR MYLAR	CONTACT PLATING	DIMENSIONS					NO. OF CONTACTS	PART NUMBER
		E	D	C	B	A		
CAP	C	8	9	6.25	5.6	4.0	12	5-1775014-4
MYLAR	B	12.8	13.8	11.05	10.4	8.8	24	1775014-2
		8	9	6.25	5.6	4.0	12	1775014-1

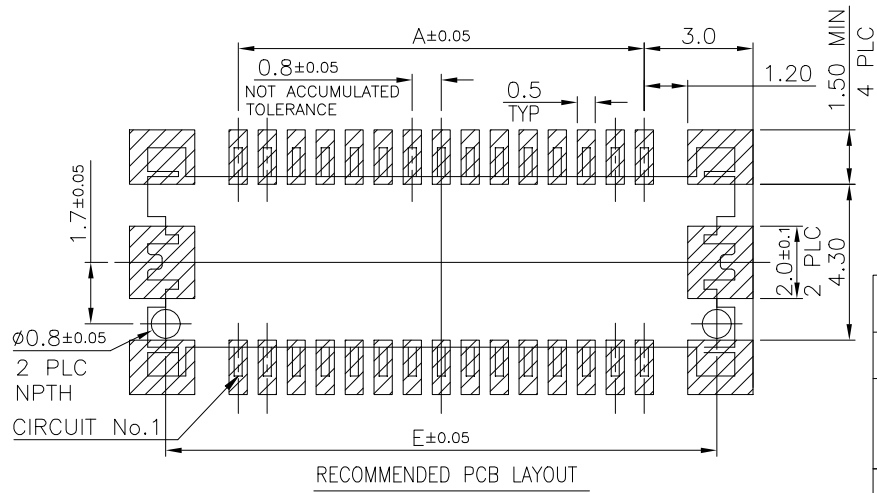

THIS DRAWING IS A CONTROLLED DOCUMENT.

DIMENSIONS: mm	TOLERANCES UNLESS OTHERWISE SPECIFIED:	DWN A. WU 05FEB2013	TE Connectivity BOARD-TO-BOARD CONNECTOR, 0.8mm PITCH, FINE-STACK 3H. PLUG
	0 PLC ± -	CHK S. CHIEN 05FEB2013	
	1 PLC ± 0.3	APVD W. KODAMA 05FEB2013	
	2 PLC ± 0.2	NAME	
MATERIAL -	FINISH -	PRODUCT SPEC 108-57488	SIZE A3
		APPLICATION SPEC -	CAGE CODE 00779
		WEIGHT 0	DRAWING NO. C=1775014
		CUSTOMER DRAWING	RESTRICTED TO -
			SCALE 7:1
			SHEET 1 OF 2
			REV G1

THIS DRAWING IS UNPUBLISHED.

RELEASED FOR PUBLICATION

ALL RIGHTS RESERVED.

© COPYRIGHT - By -

REVISIONS

P	LTR	DESCRIPTION	DATE	DWN	APVD
-	-	SEE SHEET 1	-	-	-

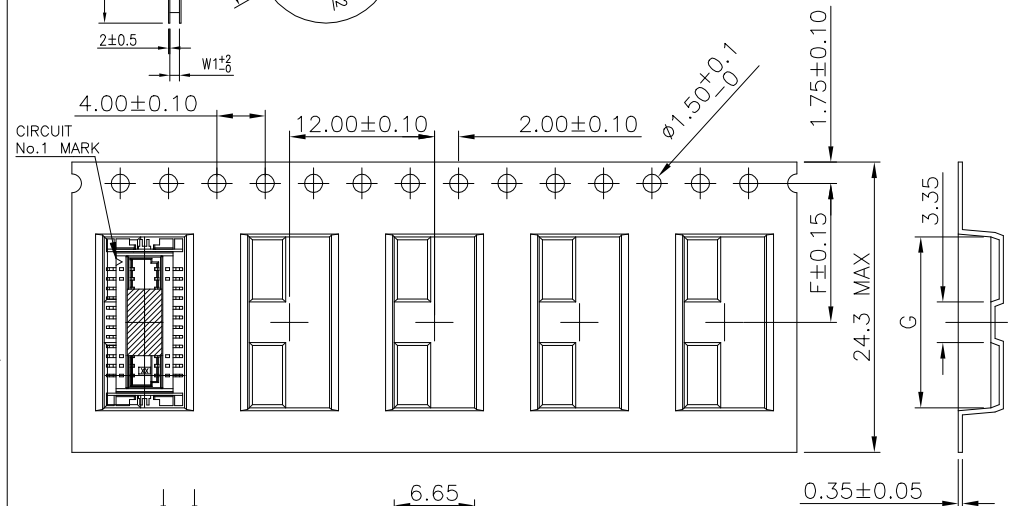
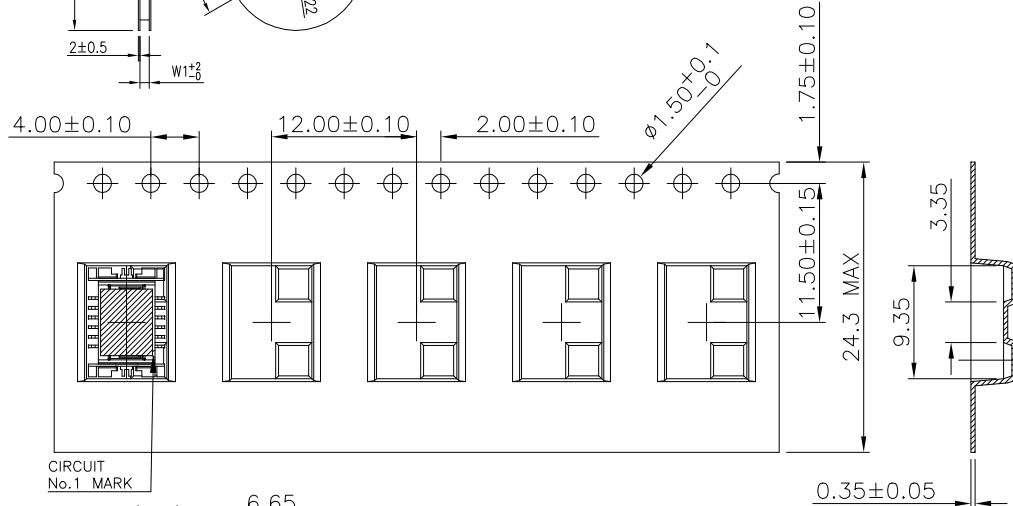
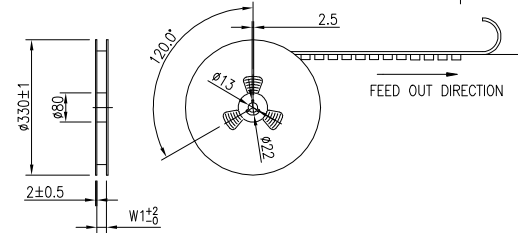
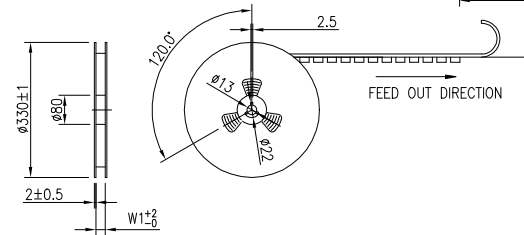
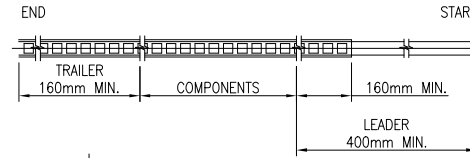
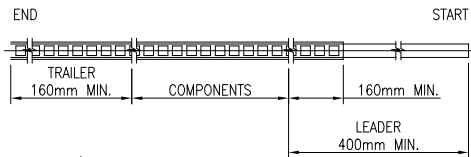

CIRCUIT No.1 MARK

CIRCUIT No.1 MARK

FOR 5-1775014-4 ONLY

FOR 12, 24 CONTACTS (WITH OR WITHOUT MYLAR)

NOTES:

- MATERIAL:  
BOX: FIBREBOARD, CORRUGATED, DOUBLE WALL.  
COVER TAPE: PET, TRANSPARENT COLOR.  
CARRIER TAPE: POLYSTYRENES, BLACK COLOR.  
REEL: PAPER, BROWN COLOR.  
BAG: POLYETHYLENES, TRANSPARENT COLOR.
- EACH BAG SHALL BE INCLUDED DESICCANT.
- PEELING STRENGTH: 0.1~1.3 N (10~130 GRAMS).
- PEELING SPEED: 300 mm/min.

1500	24.40	24.00	14.15	11.50	24
1500	24.40	24.00	9.35	11.50	12
PCS / TAPE	W1	W	G	F	NO. OF CONTACTS
DIMENSIONS					

THIS DRAWING IS A CONTROLLED DOCUMENT.		DWN A. WU 05FEB2013	TE Connectivity BOARD-TO-BOARD CONNECTOR, 0.8mm PITCH, FINE-STACK 3H. PLUG											
DIMENSIONS: mm		CHK S. CHIEN 05FEB2013												
TOLERANCES UNLESS OTHERWISE SPECIFIED:		APVD W. KODAMA 05FEB2013												
<table border="1"> <tr><td>0 PLC</td><td>± -</td></tr> <tr><td>1 PLC</td><td>± 0.3</td></tr> <tr><td>2 PLC</td><td>± 0.2</td></tr> <tr><td>3 PLC</td><td>± 0.15</td></tr> <tr><td>4 PLC</td><td>± -</td></tr> <tr><td>ANGLES</td><td>± 2'</td></tr> </table>		0 PLC				± -	1 PLC	± 0.3	2 PLC	± 0.2	3 PLC	± 0.15	4 PLC	± -
0 PLC	± -													
1 PLC	± 0.3													
2 PLC	± 0.2													
3 PLC	± 0.15													
4 PLC	± -													
ANGLES	± 2'													
MATERIAL	FINISH	APPLICATION SPEC -	SIZE A3	CAGE CODE 00779	DRAWING NO G=1775014	RESTRICTED TO -								
CUSTOMER DRAWING			SCALE 7:1	SHEET 2 OF 2	REV G1									

## X-ON Electronics

Largest Supplier of Electrical and Electronic Components

*Click to view similar products for te connectivity manufacturer:*

Other Similar products are found below :

[570416-000](#) [CLTEQ-M81CE-SSRELAY-4-20V](#) [4-1633138-8](#) [D38999/24FJ4AN](#) [4-1195131-0](#) [650069-000](#) [SMD100-2](#) [2EDL4CM](#)  
[DTS20W19-11PD-3028](#) [DTS20W19-11PD-3028-LC](#) [DTS20W19-32SD-3028-LC](#) [DTS20W19-32SD-3028](#) [NC6-P104-06](#) [TXR64AB90-](#)  
[3616AI](#) [DTS26F21-41HE](#) [DTS26F21-41AE](#) [DTS26F21-41PE-LC](#) [DTS26F21-11SE-3028-LC](#) [D38999/24WF32JE](#) [D38999/24WF32SE-LC](#)  
[DTS24W19-32HE](#) [D38999/20JB35HA](#) [D38999/24WJ20PA](#) [164-8033-08](#) [D38999/24FF32JE](#) [D38999/24FF32SE-LC](#) [D38999/24WF32JB](#)  
[D38999/24WG11HA](#) [D38999/24WG11HN](#) [MS27467T21F11H](#) [DJT16E21-11HA](#) [DTS24F19-32HE](#) [DTS20W19-32SA-3028-LC](#) [DTS24F19-](#)  
[11SC-3028-LC](#) [DTS24F19-11SC-3028](#) [DJT14E13-98HB](#) [D38999/20WC8BB](#) [1-330599-5](#) [DTS24F21-41HN-LC](#) [DTS24F21-41HN](#)  
[DTS24F21-41AN](#) [DTS24F21-39HN](#) [DTS24F21-41PN-LC](#) [AFD50-10-6SN-1A-LC](#) [DJT10F17-26HC](#) [DTS24W19-32HB](#) [ACT20JE99HA](#)  
[DJT10E17-26HC](#) [DJT10E17-26HN](#) [DJT10F17-26HA](#)