

THIS DRAWING IS UNPUBLISHED.

RELEASED FOR PUBLICATION

© COPYRIGHT -

ALL RIGHTS RESERVED.

LOC	DIST
-	-

REVISIONS

P	LTR	DESCRIPTION	DATE	DWN	APVD
A		INITIAL RELEASE	08AUG2014	PS	JK

REFERENCE MATING INTERFACE PATTERN:
1,27 STAGGERED PITCH x 1,5 ROW-DISTANCE.

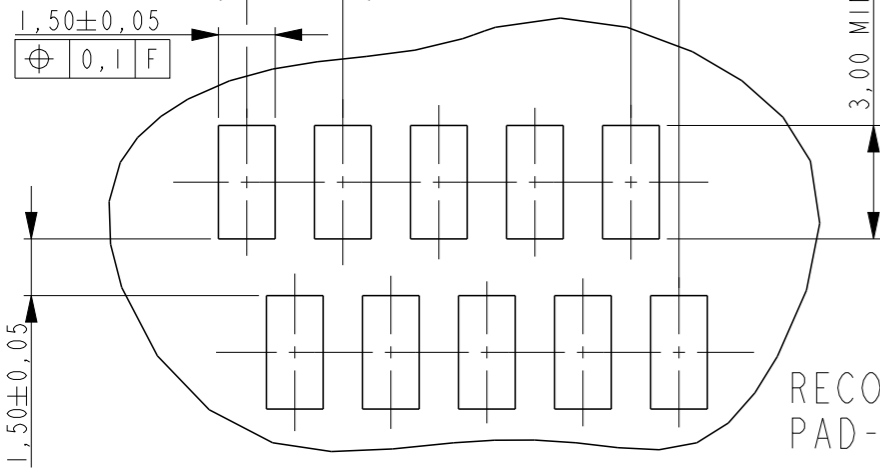
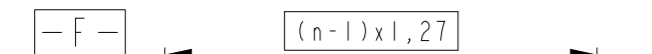
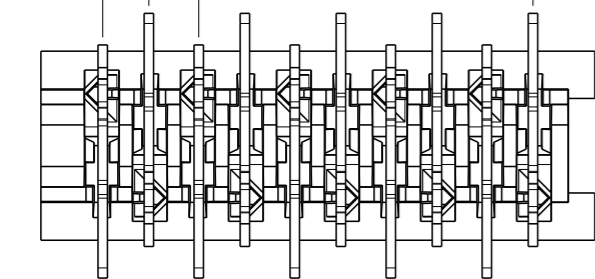
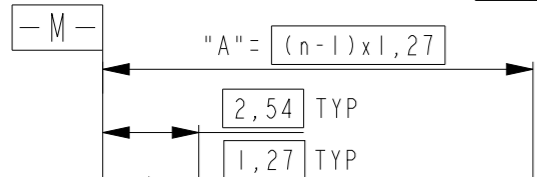
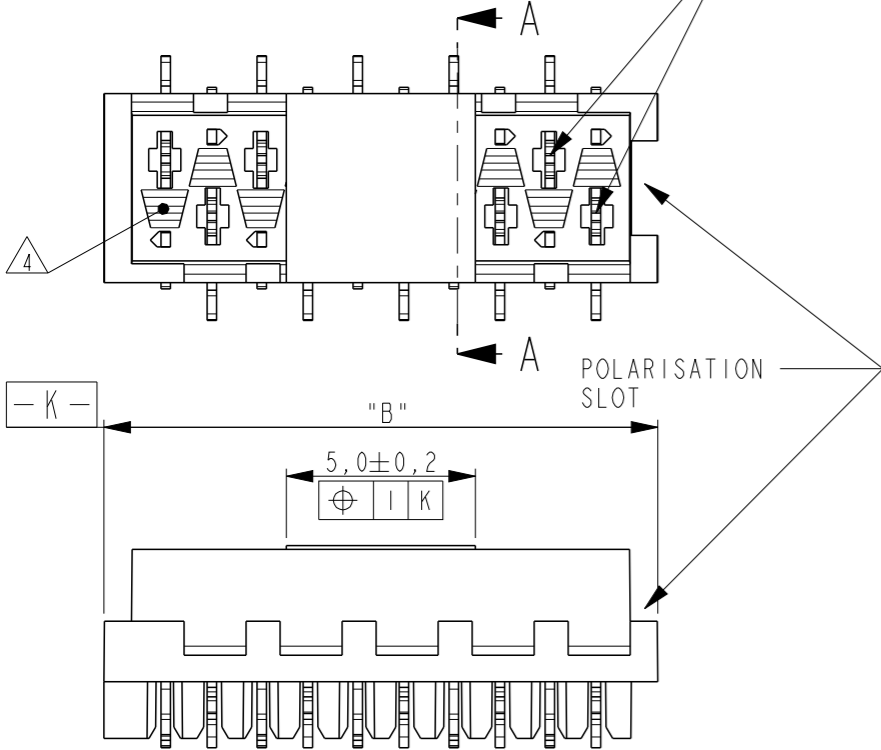

RECOMMENDED PC-BOARD
PAD-LAYOUT TOP VIEW

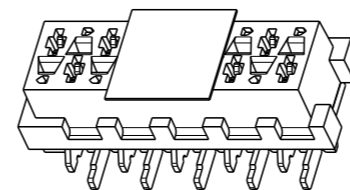
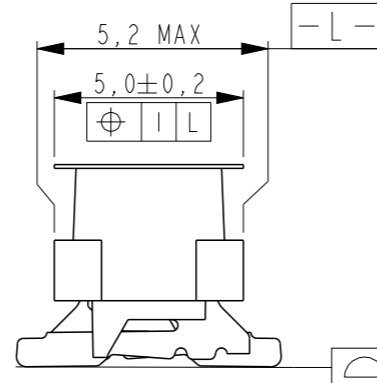
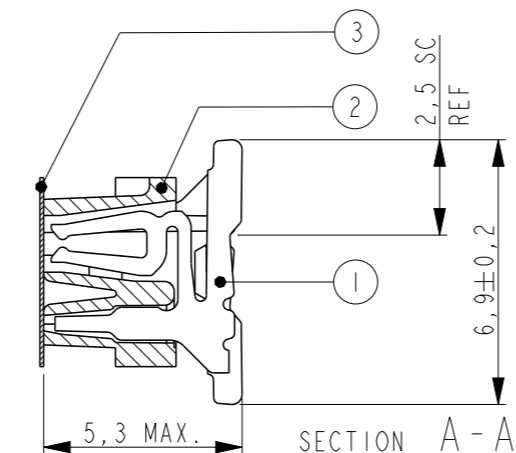

SCALE 3:1

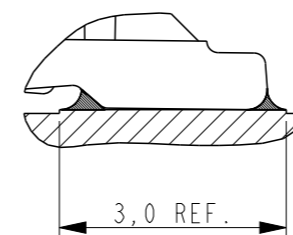

SOLDER DETAIL
SCALE 10:1

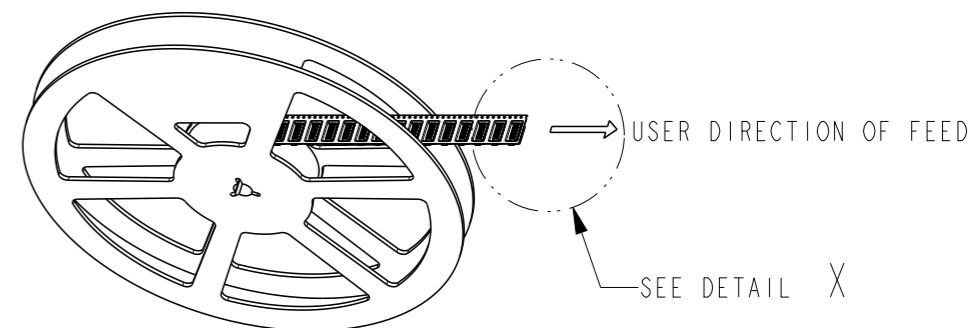
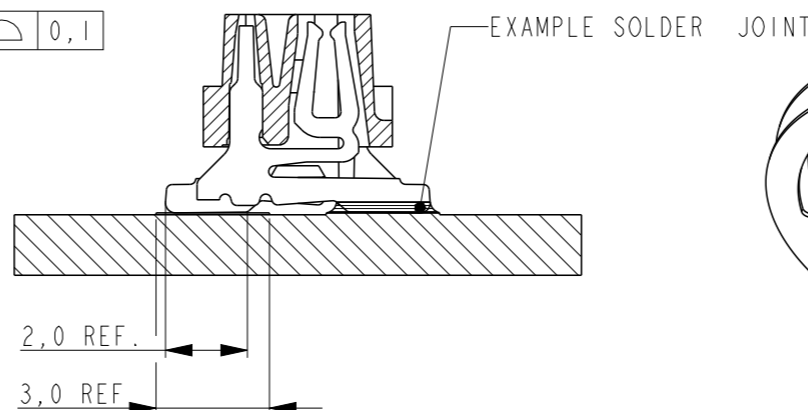

ACCORDING EIA-481/DIN IEC 286

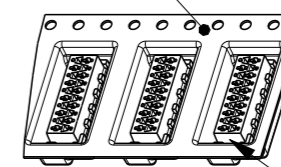

DETAIL X
SCALE 1:1
POLARIZATION-SLOT
ON THIS SIDE.

NOTES:

- 1 TAPE FOR VACUUM P&P ONLY FOR DASHNUMBERS 7- /8- /9-
- 2 FOR PACKAGING SEE SHEET 2 OF 2
- 3 WITHOUT VACUUM TAPE.
- 4 CORING-OUTS FOR MANUFACTURING PURPOSE ONLY.
SHAPE MAY VARY, BUT IS NOT FUNCTIONAL FOR THE APPLICATION.
- 5 SHOWN IS A 10 POSITION CONNECTOR.

ITEM NO.	COMPONENT DESCRIPTION	MATERIAL	FINISH / COLOR
3	PICK & PLACE TAPE	KAPTON	AMBER TRANSPARENT
2	FEMALE HOUSING	POLYAMIDE 4/6,GF	BLACK
1	FEMALE CONTACT	TIN BRASS	3.0 - 5.0µm TIN OVER 0.5µm NICKEL

THIS DRAWING IS A CONTROLLED DOCUMENT.		DWN 30JUL2014 PRASHANTH
DIMENSIONS: mm		CHK 05AUG2014 PRASHANTH
TOLERANCES UNLESS OTHERWISE SPECIFIED:		APVD 05AUG2014 JAYANTH KUMAR
0 PLC	±-	PRODUCT SPEC
1 PLC	±-	108-32087
2 PLC	±-	APPLICATION SPEC
3 PLC	±-	114-13318
4 PLC	±-	WEIGHT
ANGLES	±-	-
FINISH	SEE TABLE	CUSTOMER DRAWING

NAME		Micro-MaTch VALUE LINE	
PRODUCT SPEC		FEMALE-ON-BOARD, TOP ENTRY, SMD, CONNECTOR	
SIZE	CAGE CODE	DRAWING NO	RESTRICTED TO
A3	00779	C-2178711	-

SCALE 5:1		SHEET 1 OF 2		REV A	
-----------	--	--------------	--	-------	--

THIS DRAWING IS UNPUBLISHED.

RELEASED FOR PUBLICATION

© COPYRIGHT -

ALL RIGHTS RESERVED.

LOC - DIST -

REVISIONS

P LTR

DESCRIPTION

DATE

DWN

APVD

SEE SHEET 1

TAPE WIDTH 24 mm

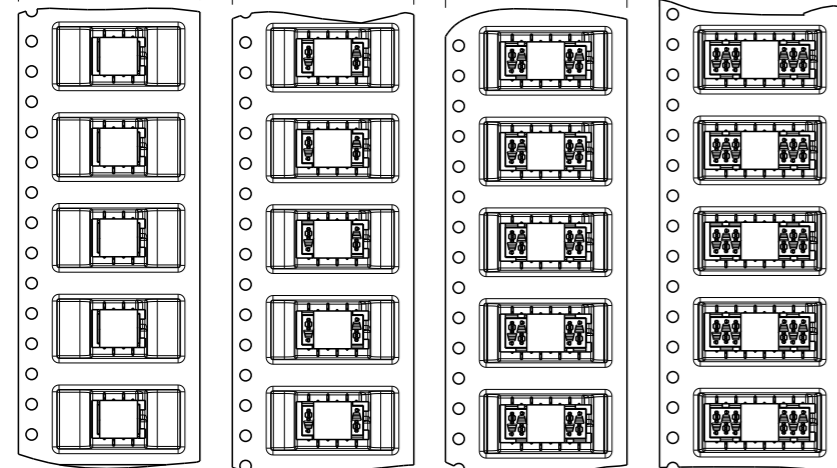

7-2178711-4 4 POSITION 2178711-4
7-2178711-6 6 POSITION 2178711-6
7-2178711-8 8 POSITION 2178711-8
8-2178711-0 10 POSITION 1-2178711-0

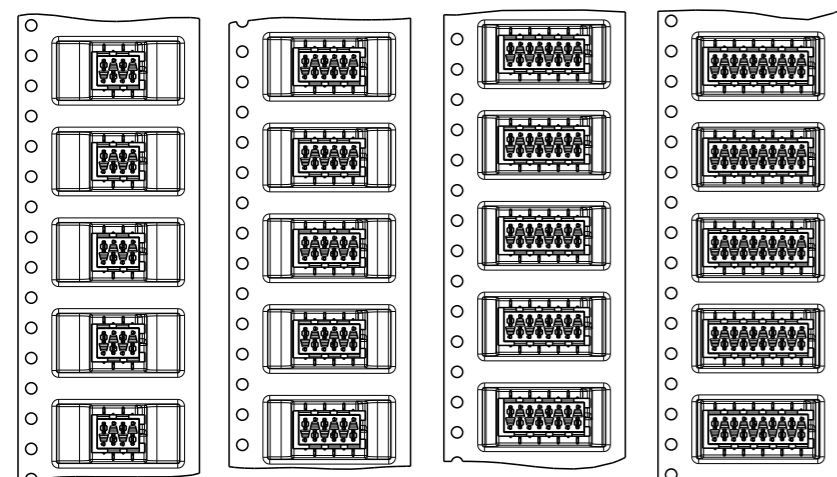

TAPE WIDTH 44 mm

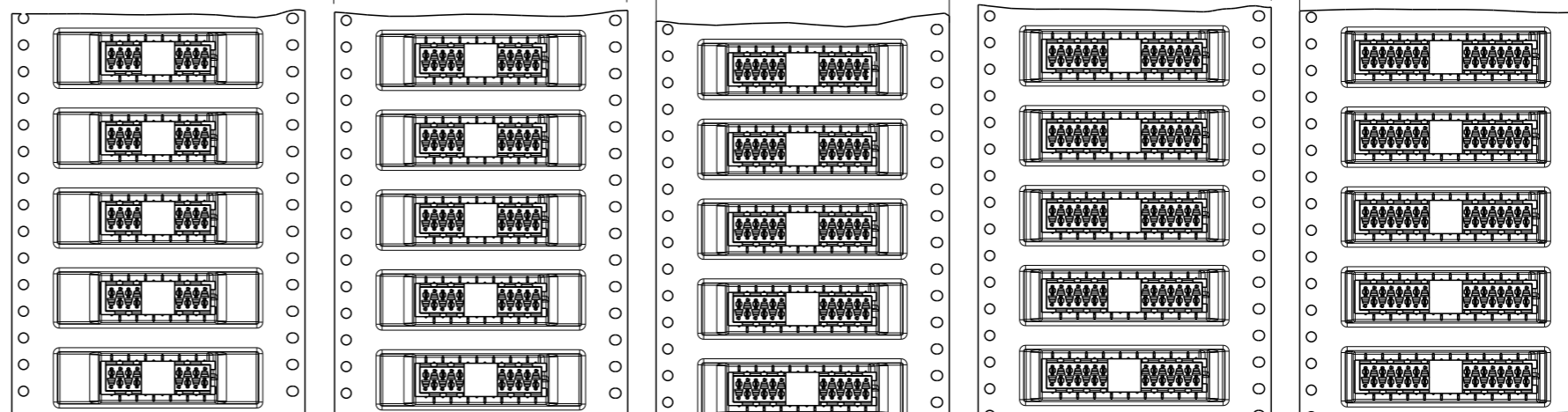

8-2178711-2 12 POSITION 1-2178711-2
8-2178711-4 14 POSITION 1-2178711-4
8-2178711-6 16 POSITION 1-2178711-6
8-2178711-8 18 POSITION 1-2178711-8
9-2178711-0 20 POSITION 2-2178711-0

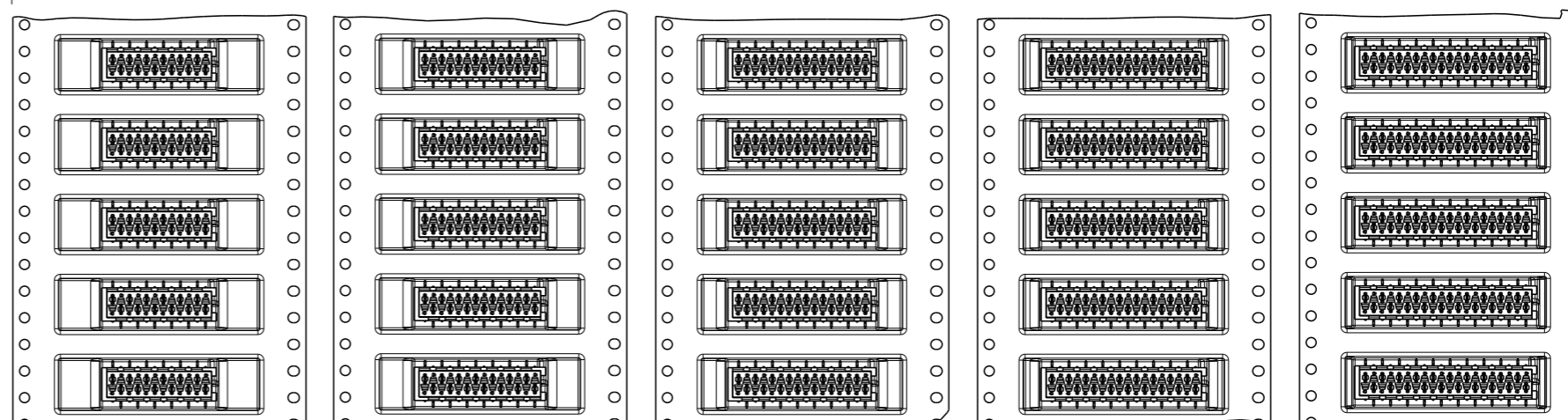

THIS DRAWING IS A CONTROLLED DOCUMENT.

DIMENSIONS: mm

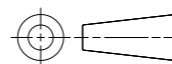

TOLERANCES UNLESS OTHERWISE SPECIFIED:

- 0 PLC ±-
1 PLC ±0.1
2 PLC ±0.05
3 PLC ±-
4 PLC ±-
ANGLES ±-
FINISH -

MATERIAL -

DWN 25JUL2014 PRASHANTH

CHK 05AUG2014 PRASHANTH

APVD 05AUG2014 JAYANTH KUMAR

PRODUCT SPEC 108-32087

APPLICATION SPEC 114-13318

WEIGHT -

CUSTOMER DRAWING



Micro-MaTch VALUE LINE FEMALE-ON-BOARD, TOP ENTRY, SMD, CONNECTOR

SIZE CAGE CODE DRAWING NO RESTRICTED TO

A3 00779 C-2178711

SCALE 1:1 SHEET 2 OF 2 REV A

X-ON Electronics

Largest Supplier of Electrical and Electronic Components

Click to view similar products for [Headers & Wire Housings](#) category:

Click to view products by [TE Connectivity](#) manufacturer:

Other Similar products are found below :

[892-18-020-10-001101](#) [58102-G61-06LF](#) [582553-1](#) [0009485154](#) [009176003701906](#) [0050291907](#) [LY20-4P-DT1-P1E-BR](#) [02.125.8002.8](#)
[609-3404](#) [61062-3](#) [61082-181009](#) [622-3653LF](#) [63453-116](#) [636-1030](#) [636-1427](#) [636-3427](#) [636-4007](#) [641938-9](#) [641991-4](#) [644827-2](#) [65817-](#)
[010LF](#) [65817-015LF](#) [65863-015LF](#) [66207-023LF](#) [67095-007LF](#) [67601157](#) [68645-018](#) [68648-049](#) [70.362.1628.0](#) [70-4210](#) [70-4226B](#) [70-](#)
[4853B](#) [707-5020](#) [707-5028](#) [71.350.2428.0](#) [71918-208LF](#) [71961-016LF](#) [733-134](#) [733-162](#) [754199-000](#) [760-3052](#) [79531-3000](#) [FCN-](#)
[360C032-B](#) [FCN-367T-T012/H](#) [FCN-723D010/2](#) [80.063.4001.1](#) [800-90-001-10-001000](#) [800-90-010-10-002000](#) [801-43-002-10-013000](#)
[801-43-006-10-002000](#)