

THIS DRAWING IS UNPUBLISHED. RELEASED FOR PUBLICATION 20  
 © COPYRIGHT 20 BY - ALL RIGHTS RESERVED.

REVISIONS					
P	LTR	DESCRIPTION	DATE	DWN	APVD
	A	INITIAL RELEASE	29MAY2019	OL	SZ

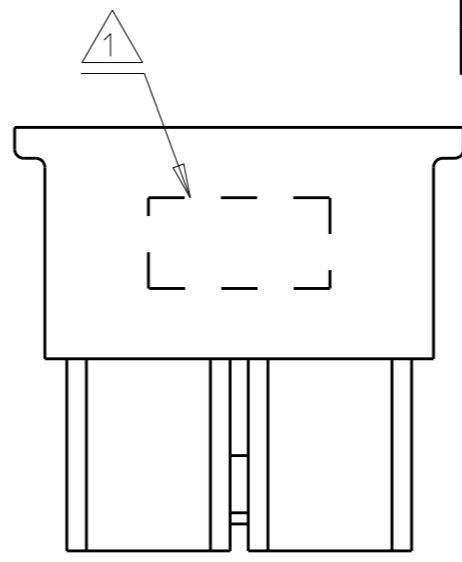

- NOTES:
1. PART NUMBER AND DATE CODE.
  2. MATERIAL: THERMO PLASTIC, UL94 V-0, COLOR: SEE PART NUMBER LIST.
  3. THIS RECEPTACLE HOUSING TO BE USED WITH RECEPTACLE TERMINAL 2204749.
  4. PACKAGED IN BULK BY BAG.

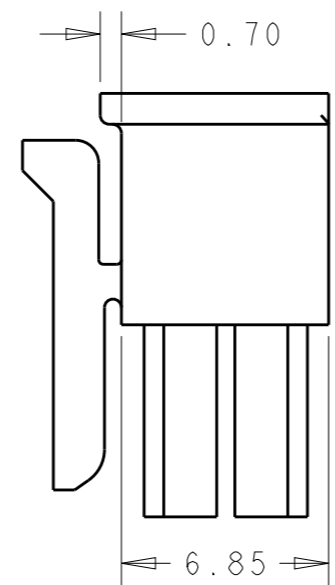
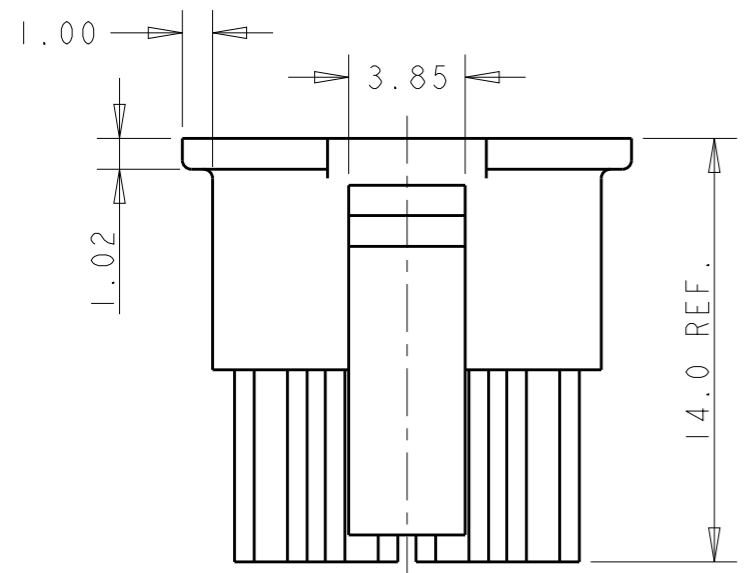
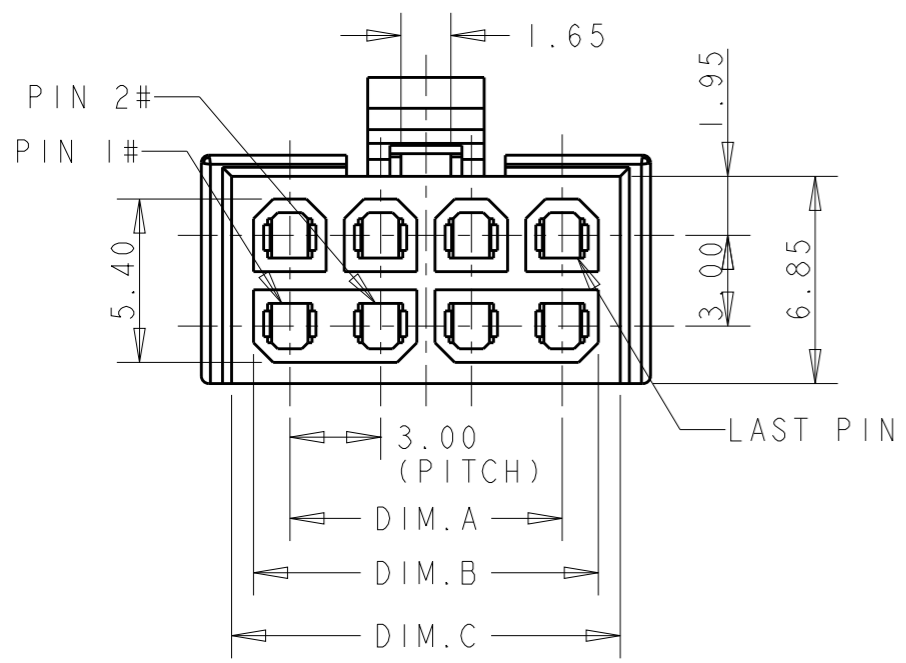

36.85	35.40	33.00	NATURE	24	2-2204748-4
33.85	32.40	30.00	NATURE	22	2-2204748-3
30.85	29.40	27.00	NATURE	20	2-2204748-2
27.85	26.40	24.00	NATURE	18	2-2204748-1
24.85	23.40	21.00	NATURE	16	2-2204748-0
21.85	20.40	18.00	NATURE	14	1-2204748-9
18.85	17.40	15.00	NATURE	12	1-2204748-8
15.85	14.40	12.00	NATURE	10	1-2204748-7
12.85	11.40	9.00	NATURE	8	1-2204748-6
9.85	8.40	6.00	NATURE	6	1-2204748-5
6.85	5.40	3.00	NATURE	4	1-2204748-4
3.85	2.40	N/A	NATURE	2	1-2204748-3
DIM.C	DIM.B	DIM.A	COLOR	CIRCUIT	PART NUMBER

36.85	35.40	33.00	BLACK	24	1-2204748-2
33.85	32.40	30.00	BLACK	22	1-2204748-1
30.85	29.40	27.00	BLACK	20	1-2204748-0
27.85	26.40	24.00	BLACK	18	2204748-9
24.85	23.40	21.00	BLACK	16	2204748-8
21.85	20.40	18.00	BLACK	14	2204748-7
18.85	17.40	15.00	BLACK	12	2204748-6
15.85	14.40	12.00	BLACK	10	2204748-5
12.85	11.40	9.00	BLACK	8	2204748-4
9.85	8.40	6.00	BLACK	6	2204748-3
6.85	5.40	3.00	BLACK	4	2204748-2
3.85	2.40	N/A	BLACK	2	2204748-1
DIM.C	DIM.B	DIM.A	COLOR	CIRCUIT	PART NUMBER

THIS DRAWING IS A CONTROLLED DOCUMENT.		DWN 9-Aug-18 RADAR SUN	 TE Connectivity	
DIMENSIONS: mm		CHK 9-Aug-18 SUNY ZHAO		
TOLERANCES UNLESS OTHERWISE SPECIFIED:		APVD 9-Aug-18 SUNY ZHAO	NAME ELCON MICRO POWER CONNECTOR, RECEPTACLE, HOUSING, 3.00MM PITCH, 2XN CIRCUITS	
0 PLC ±- 1 PLC ±±0.30 2 PLC ±±0.20 3 PLC ±- 4 PLC ±- ANGLES ±-		PRODUCT SPEC 108-128068	SIZE CAGE CODE DRAWING NO RESTRICTED TO	
MATERIAL -		APPLICATION SPEC -	A300779 C-2204748	
FINISH -		WEIGHT -	SCALE 4:1 SHEET 1 OF 2 REV A	
		CUSTOMER DRAWING		

REVISIONS

P	LTR	DESCRIPTION	DATE	DWN	APVD
	-	SEE SHEET 1	-	-	-

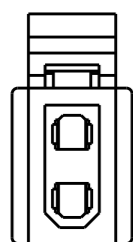

CIRCUIT SIZE:2

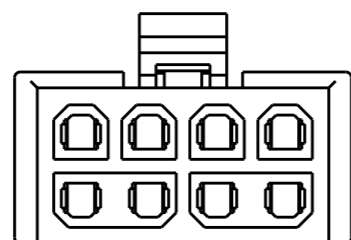

CIRCUIT SIZE:8

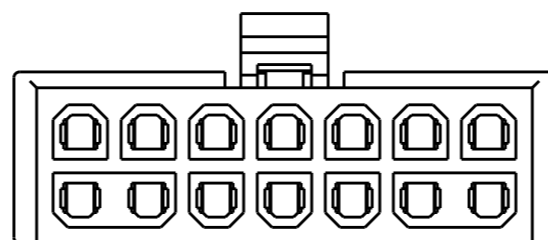

CIRCUIT SIZE:14

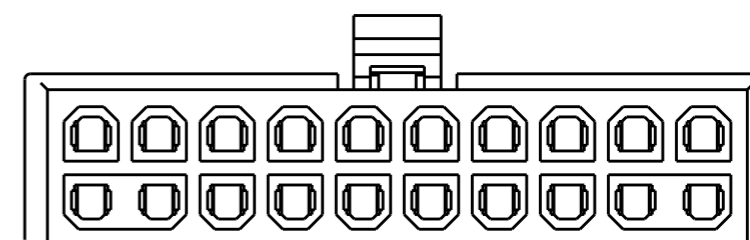

CIRCUIT SIZE:20

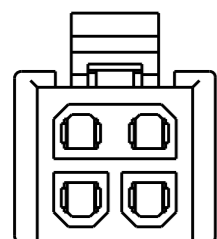

CIRCUIT SIZE:4

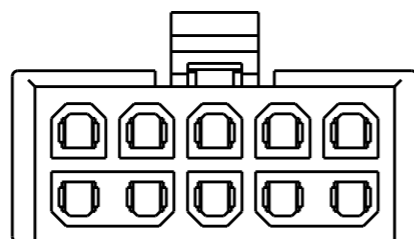

CIRCUIT SIZE:10

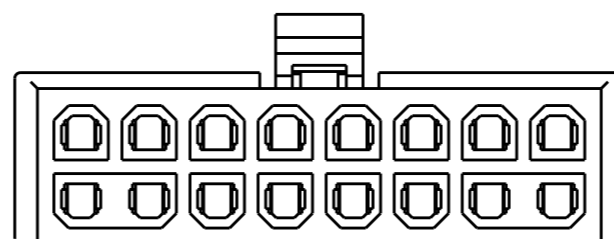

CIRCUIT SIZE:16

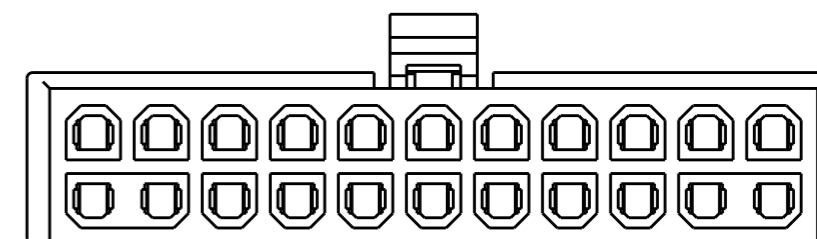

CIRCUIT SIZE:22

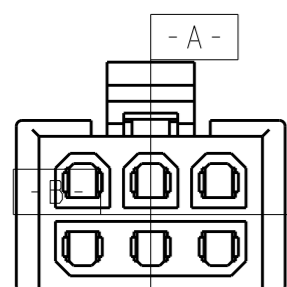

CIRCUIT SIZE:6

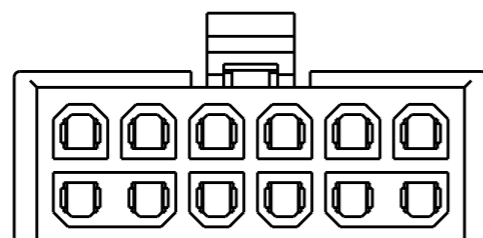

CIRCUIT SIZE:12

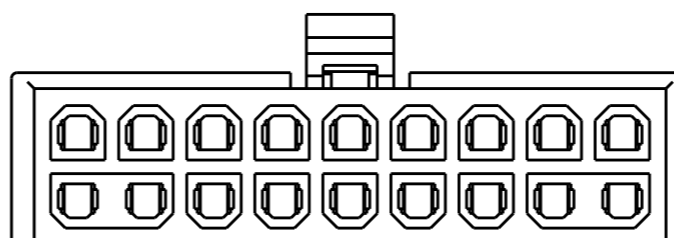

CIRCUIT SIZE:18

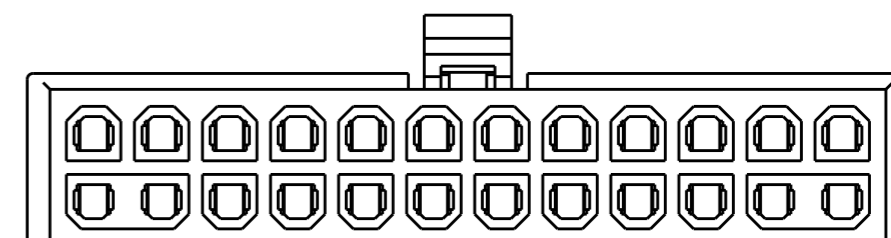

CIRCUIT SIZE:24

THIS DRAWING IS A CONTROLLED DOCUMENT.

DIMENSIONS: mm		TOLERANCES UNLESS OTHERWISE SPECIFIED:	
		0 PLC	±-
		1 PLC	±±0.30
		2 PLC	±±0.20
		3 PLC	±-
		4 PLC	±-
MATERIAL		FINISH	
-		-	

DWN	RADAR SUN	9-Aug-18
CHK	SUNY ZHAO	9-Aug-18
APVD	SUNY ZHAO	9-Aug-18
PRODUCT SPEC	108-128068	
APPLICATION SPEC	-	
WEIGHT	-	
CUSTOMER DRAWING		



NAME ELCON MICRO POWER CONNECTOR, RECEPTACLE, HOUSING, 3.00MM PITCH, 2XN CIRCUITS			
SIZE	CAGE CODE	DRAWING NO	RESTRICTED TO
A3	00779	C-2204748	-
SCALE		SHEET	REV
3:1		2 OF 2	A

## X-ON Electronics

Largest Supplier of Electrical and Electronic Components

*Click to view similar products for [Heavy Duty Power Connectors](#) category:*

*Click to view products by [TE Connectivity](#) manufacturer:*

Other Similar products are found below :

[647757-1](#) [6643411-1](#) [6646058-2](#) [6646137-1](#) [6646138-1](#) [6646479-1](#) [6646608-1](#) [6646786-1](#) [6646940-1](#) [6651091-1](#) [6651525-1](#) [6651529-1](#)  
[6651788-1](#) [696475-1](#) [702-32-01109](#) [703-25-02205](#) [73000005059](#) [73000005642](#) [73080255059](#) [73080965046](#) [765-15-0080A](#) [765-16-0080B](#)  
[765-18-0080D](#) [829992-1](#) [902-77-02113](#) [PS00/A0620/6300](#) [PS25/A0420/63](#) [129-1J](#) [1409400](#) [AN0024023](#) [E6374G1](#) [e6389g2](#) [157-43GW8](#)  
[MS3117-14AC](#) [1643543-1](#) [1650540-1](#) [1651811-2](#) [1766260-1](#) [1766282-1](#) [1766966-1](#) [1791340000](#) [NLDFT-3-BL-L-S120-M40A](#) [NLDFT-N-](#)  
[W-L-C240-M40B](#) [NLS-2-R-C240-M40B](#) [NLS-N-W-C240-M40B](#) [NPS-3-BL-T6](#) [1986615-1](#) [2-1589900-8](#) [2199314-1](#) [KA8102](#)