

THIS DRAWING IS UNPUBLISHED. RELEASED FOR PUBLICATION  
 © COPYRIGHT - Tyco Electronics JAPAN G.K. ALL RIGHTS RESERVED.

LOC	DIST	REVISIONS					
		P	LTR	DESCRIPTION	DATE	DWN	APVD
ES	-	C		ECR-17-006884	12MAY2017	B.L	C.W

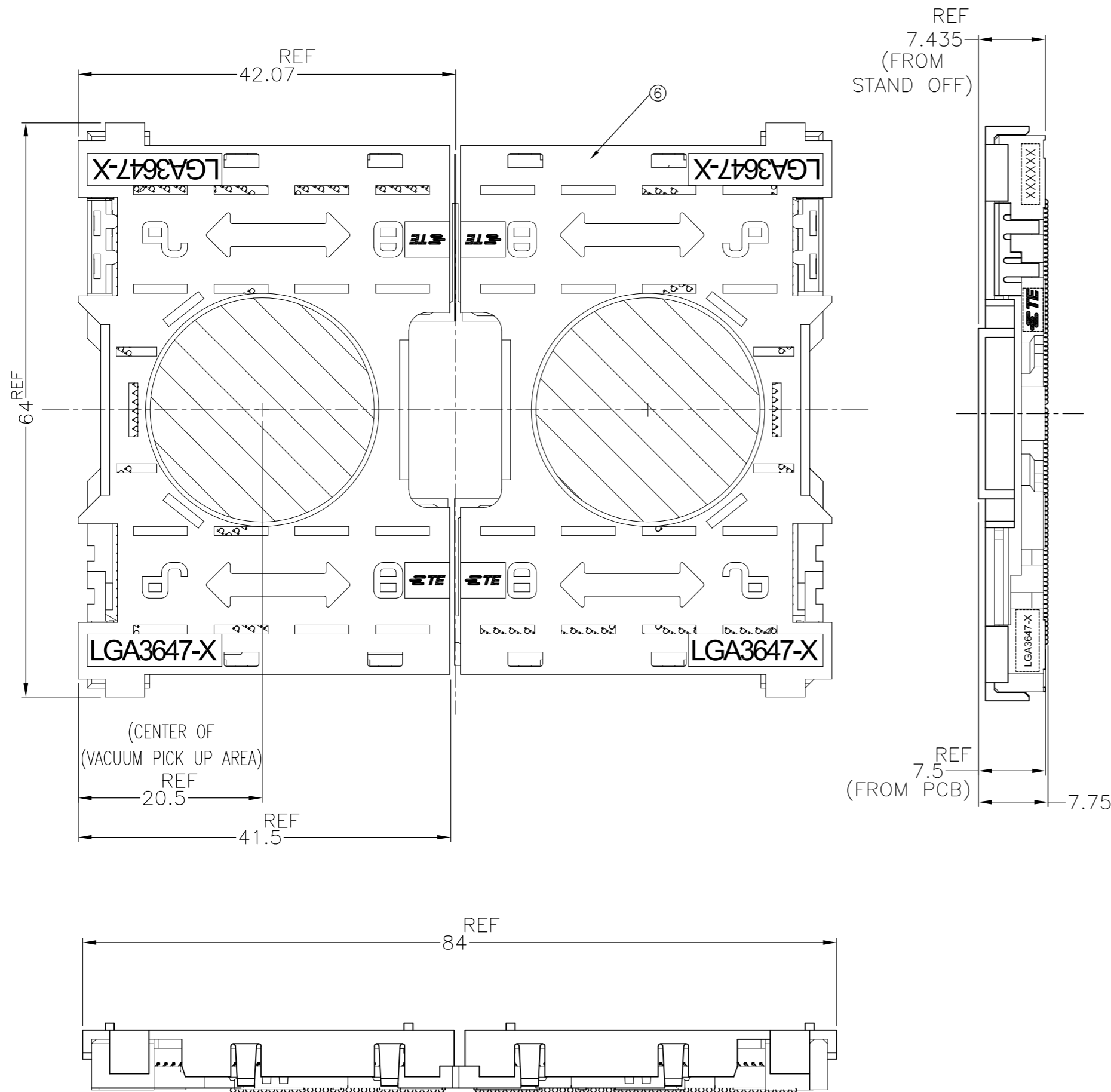

AFTER SMT CONDITION (WITH CAP)  
 DEMONSTRATION BY SOCKET P1,LGA3647-1

1. MATERIAL

- ① HOUSING : HIGH TEMP, THERMO-PLASTIC, UL94V-0, BLACK
  - ② CONTACT : COPPER ALLOY  
FINISH : Au PL. SHOW AS  $\Delta$  AT CONTACT AREA  
ON OVERALL OVER Ni UNDER PL. 0.00127 MIN.
  - ③ SOLDER BALL : Sn/Ag/Cu
  - ④ KEY HSG LEFT : HIGH TEMP. THERMO-PLASTIC, UL94V-0, BLACK
  - ⑤ KEY HSG RIGHT: HIGH TEMP. THERMO-PLASTIC, UL94V-0, P0 YELLOW, P1 NATURAL
  - ⑥ CAP : HIGH TEMP. THERMO-PLASTIC, UL94V-0, NATURAL
- $\Delta$  INDICATED DATE CODE , TYCO LOGO, PRODUCT NAME ON THE HSG  
 $\Delta$  FOR NORMAL ORDER, LEFT AND RIGHT SEGMENT SHOULD ORDER AT SAME TIME

LGA3647-1 SOCKET P1				LGA3647-0 SOCKET P0				PRODUCT NAME
30u Au PLATING		15u Au PLATING		30u Au PLATING		15u Au PLATING		
LGA3647-1 RIGHT SEGMENT	LGA3647-1 LEFT SEGMENT	LGA3647-1 RIGHT SEGMENT	LGA3647-1 LEFT SEGMENT	LGA3647-0 RIGHT SEGMENT	LGA3647-0 LEFT SEGMENT	LGA3647-0 RIGHT SEGMENT	LGA3647-0 LEFT SEGMENT	ASSY PART NUMBER
2822980-4	1-2822980-4	2822980-2	1-2822980-2	2822980-3	1-2822980-3	2822980-1	1-2822980-1	

14.5	21	17	1						2-2129710-8
		16		1					2-2129710-7
	21	17			1				2-2129710-6
		16				1			2-2129710-5
									2-2129710-4
									2-2129710-3
									2-2129710-2
									2-2129710-1

PRODUCT WEIGHT (g/SOCKET)	DIMENSION D2	DIMENSION D1	QTY.		PACKAGE PART NO.
THIS DRAWING IS A CONTROLLED DOCUMENT.					
DIMENSIONS: mm		TOLERANCES UNLESS OTHERWISE SPECIFIED:		NAME	
0-PLC ± 1-PLC ± ±0.3 2-PLC ± ±3 3-PLC ± ±3 4-PLC ± ± ANGLES ± -		DWN T.KUO 04MAR2015 CHK M.CHAO 04MAR2015 APVD M.CHAO 04MAR2015 PRODUCT SPEC 108-115115 APPLICATION SPEC 114-115011		TE Connectivity SOCKET ASSY LGA3647-X	
MATERIAL	FINISH	WEIGHT	SIZE	CAGE CODE	DRAWING NO
-	-	-	A2	00779	C=2129710
CUSTOMER DRAWING			SCALE	SHEET	REV
			NTS	1 OF 7	C

THIS DRAWING IS UNPUBLISHED. RELEASED FOR PUBLICATION  
 © COPYRIGHT - Tyco Electronics JAPAN G.K. ALL RIGHTS RESERVED.

LOC		DIST		REVISIONS			
P	LTR	DESCRIPTION	DATE	DWN	APVD		
-	-	SEE SHEET 1	-	-	-		

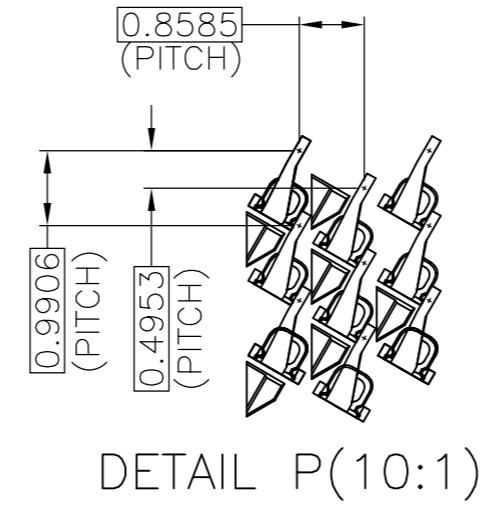
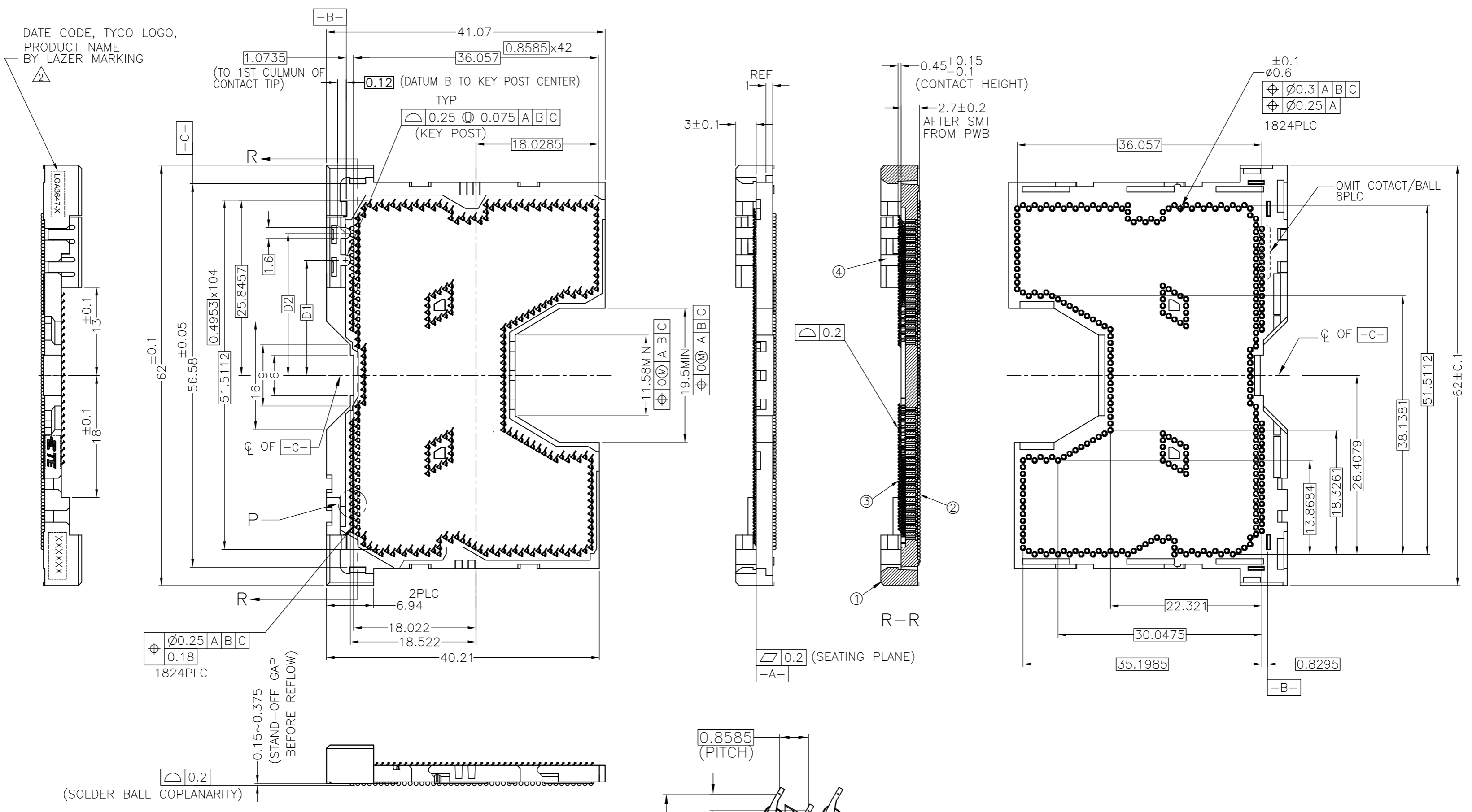

THESE VIEW DON'T SHOW CAP BEFORE SMT CONDITION  
 LGA3647-1 LEFT SIDE ASSY  
 1-2822980-\* AS SHOWN

THIS DRAWING IS A CONTROLLED DOCUMENT.		DWN	TE Connectivity		
DIMENSIONS: mm		CHK	NAME		
TOLERANCES UNLESS OTHERWISE SPECIFIED:		APVD	SOCKET ASSY LGA3647-X		
0-PLC ±		PRODUCT SPEC	SIZE	CAGE CODE	DRAWING NO
1-PLC ± ±0.3		APPLICATION SPEC	A2	00779	C=2129710
2-PLC ± ±3		WEIGHT	RESTRICTED TO		
3-PLC ± ±3		CUSTOMER DRAWING	SCALE NTS SHEET 2 OF 7 REV C		
4-PLC ± ±					
ANGLES ±					
FINISH					

THIS DRAWING IS UNPUBLISHED. RELEASED FOR PUBLICATION  
 © COPYRIGHT - Tyco Electronics JAPAN G.K. ALL RIGHTS RESERVED.

LOC	DIST	REVISIONS					
		P	LTR	DESCRIPTION	DATE	DWN	APVD
ES	-	-	-	SEE SHEET 1	-	-	-

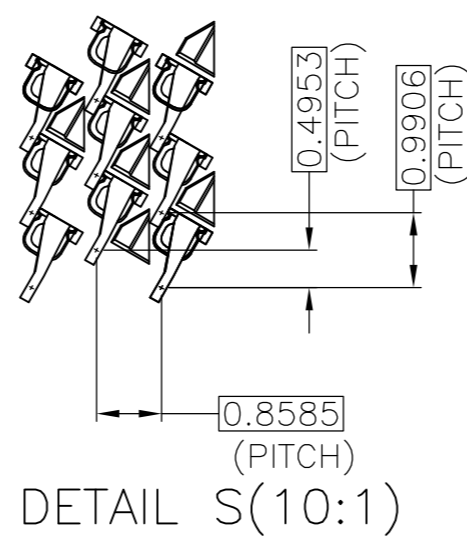
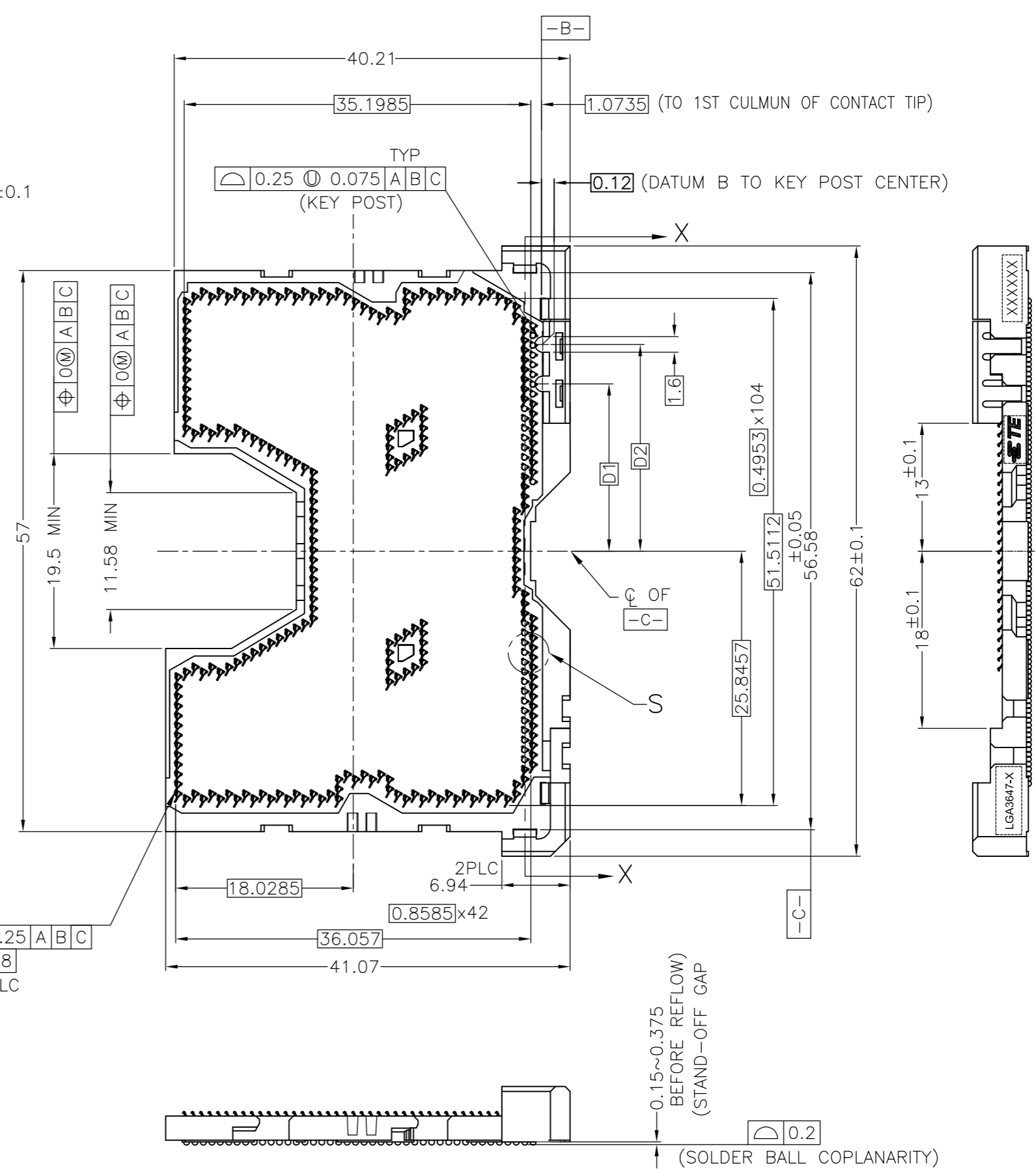
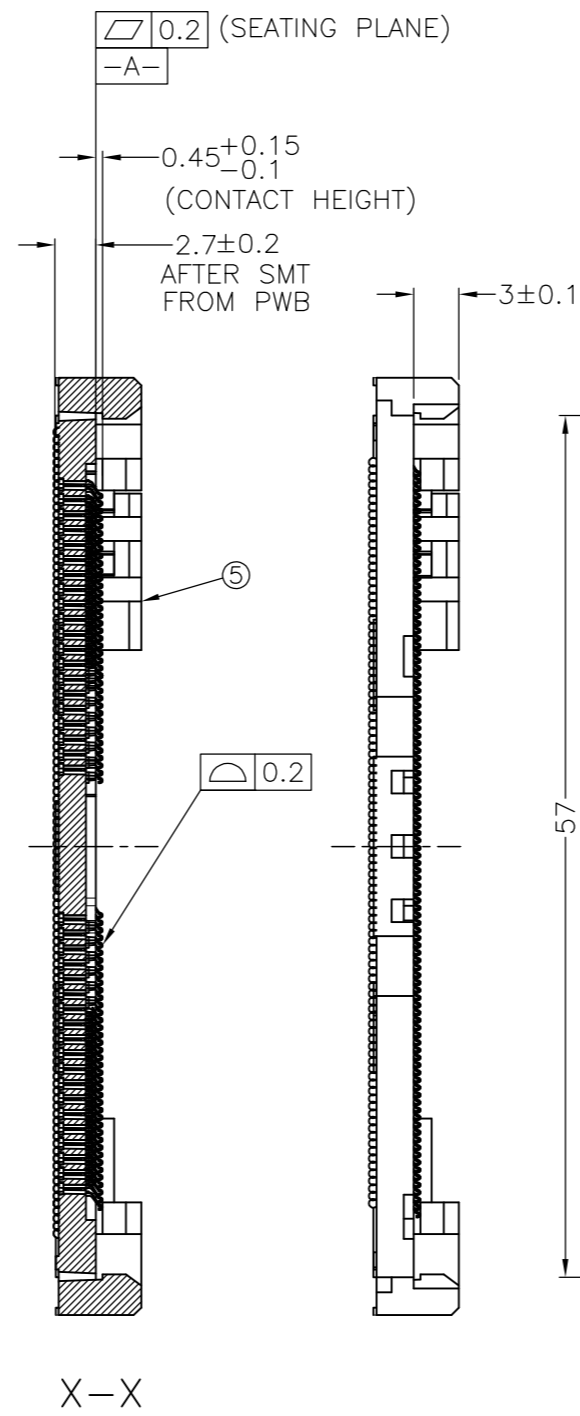
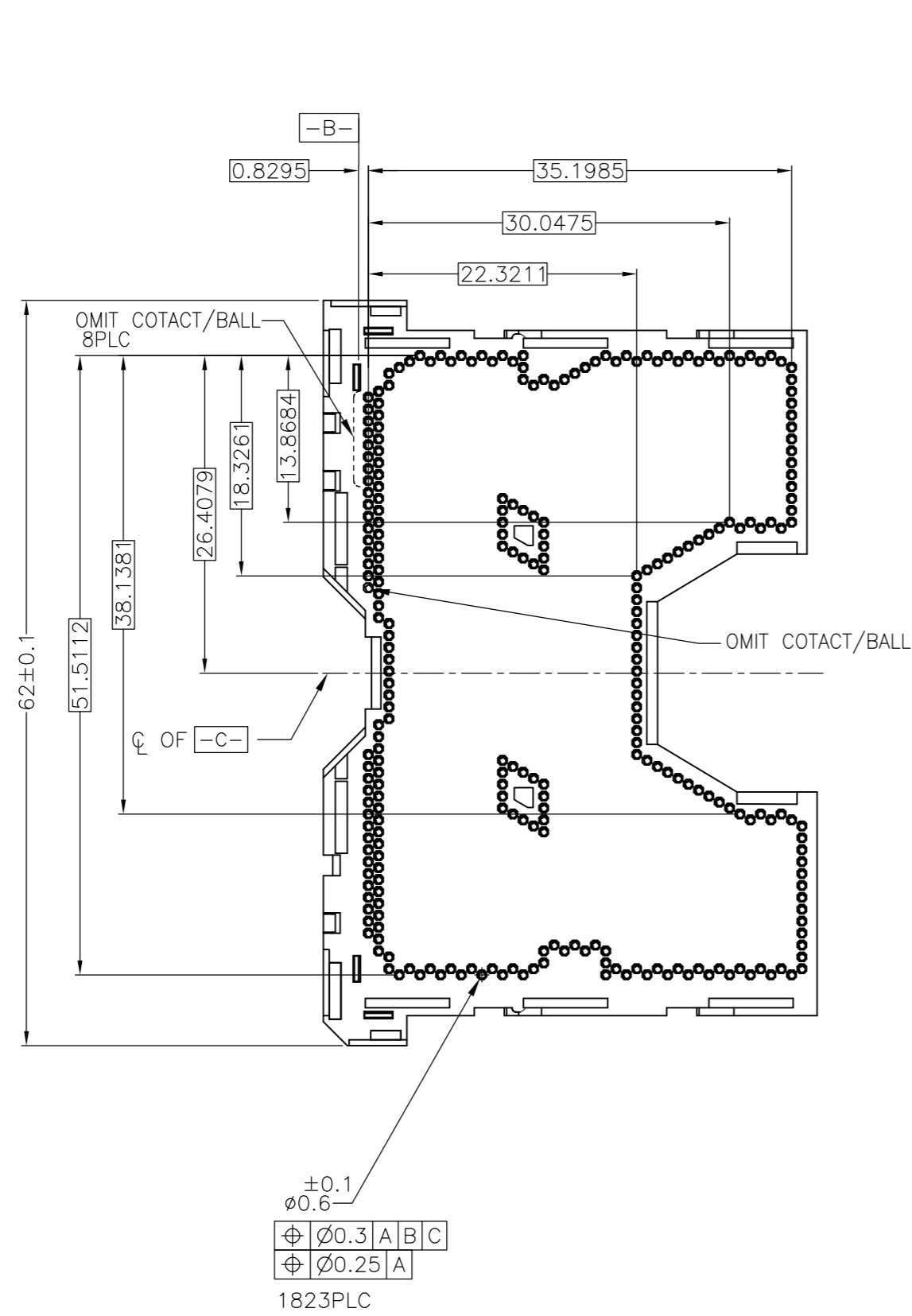

THESE VIEW DON'T SHOW CAP BEFORE SMT CONDITION LGA3647-1 RIGHT SIDE ASSY 2822980-\* AS SHOWN

THIS DRAWING IS A CONTROLLED DOCUMENT.		DWN	TE Connectivity	
DIMENSIONS: mm		CHK	NAME	
TOLERANCES UNLESS OTHERWISE SPECIFIED:		APVD	SOCKET ASSY LGA3647-X	
0-PLC ±		PRODUCT SPEC	SIZE	CAGE CODE
1-PLC ± ±0.3		APPLICATION SPEC	A2	00779
2-PLC ± ±3		WEIGHT	DRAWING NO	RESTRICTED TO
3-PLC ±		CUSTOMER DRAWING	C=2129710	-
4-PLC ±		SCALE	NTS	SHEET 3 OF 7
ANGLES ±		REV	C	
FINISH				

THIS DRAWING IS UNPUBLISHED. RELEASED FOR PUBLICATION  
 © COPYRIGHT - Tyco Electronics JAPAN G.K. ALL RIGHTS RESERVED.

LOC	DIST	REVISIONS					
		P	LTR	DESCRIPTION	DATE	DWN	APVD
ES	-	-	-	SEE SHEET 1	-	-	-

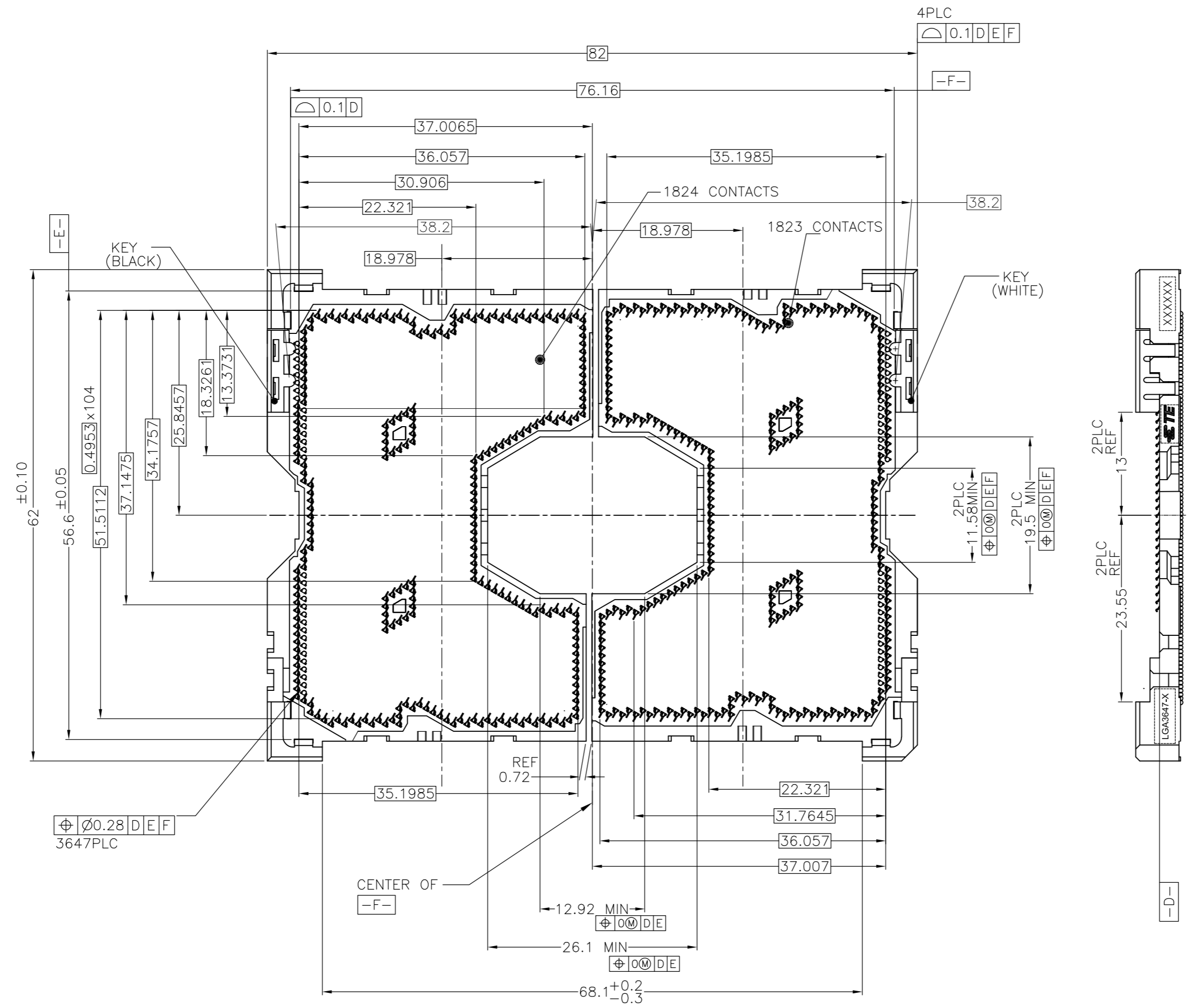

AFTER SMT CONDITION

THIS DRAWING IS A CONTROLLED DOCUMENT.		DWN	-	TE Connectivity	
DIMENSIONS: mm		CHK	-		
TOLERANCES UNLESS OTHERWISE SPECIFIED:		APVD	-	NAME	
$\phi$ - PLC $\pm$ - 1 - PLC $\pm$ - 2 - PLC $\pm$ - 3 - PLC $\pm$ - 4 - PLC $\pm$ - ANGLES $\pm$ -		PRODUCT SPEC		SOCKET ASSY LGA3647-X	
MATERIAL		APPLICATION SPEC		SIZE	RESTRICTED TO
FINISH		WEIGHT		CAGE CODE	DRAWING NO
		CUSTOMER DRAWING		A2 00779	C=2129710
		SCALE		SHEET	REV
		NTS		4 OF 7	C

THIS DRAWING IS UNPUBLISHED. RELEASED FOR PUBLICATION  
 © COPYRIGHT - Tyco Electronics JAPAN G.K. ALL RIGHTS RESERVED.

LOC	DIST	REVISIONS					
ES	-	P	LTR	DESCRIPTION	DATE	DWN	APVD
		-	-	SEE SHEET 1	-	-	-

D

C

B

A

D

C

B

A

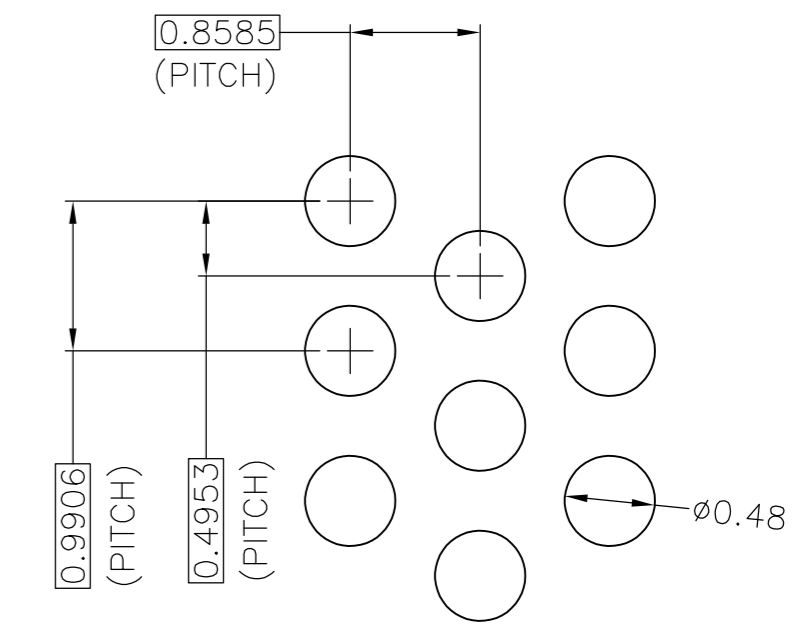
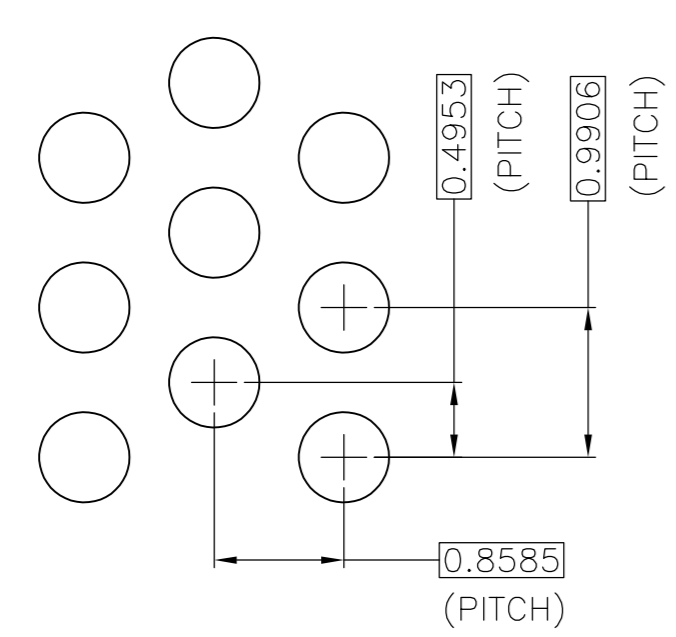
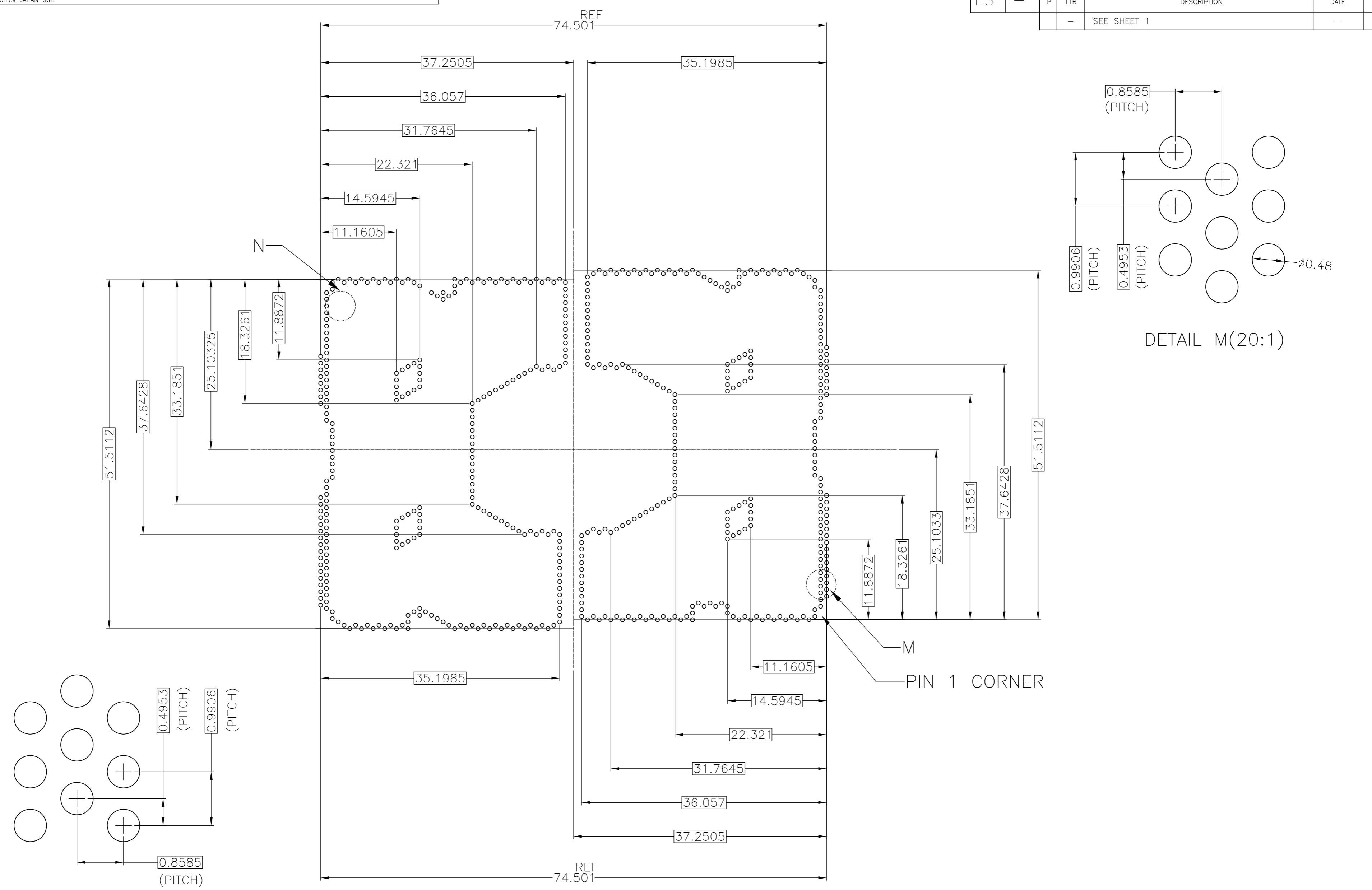

DETAIL N(20:1)

DETAIL M(20:1)

THIS DRAWING IS A CONTROLLED DOCUMENT.		DWN	-		
DIMENSIONS: mm		CHK	-		
TOLERANCES UNLESS OTHERWISE SPECIFIED:		APVD	-		
0-PLC ±		NAME			
1-PLC ± ±0.3		PRODUCT SPEC			
2-PLC ± ±3		APPLICATION SPEC			
3-PLC ±		SIZE	CAGE CODE	DRAWING NO	RESTRICTED TO
4-PLC ±		A2	00779	C=2129710	-
ANGLES ±		CUSTOMER DRAWING			
FINISH		SCALE	SHEET	REV	
		NTS	5 of 7	C	



SOCKET ASSY  
LGA3647-X

2129710

THIS DRAWING IS UNPUBLISHED. RELEASED FOR PUBLICATION  
 © COPYRIGHT - Tyco Electronics JAPAN G.K. ALL RIGHTS RESERVED.

LOC	DIST	REVISIONS					
		P	LTR	DESCRIPTION	DATE	DWN	APVD
ES	-	-	-	SEE SHEET 1	-	-	-

SOCKET P0,LGA3647-0 AS SHOWN

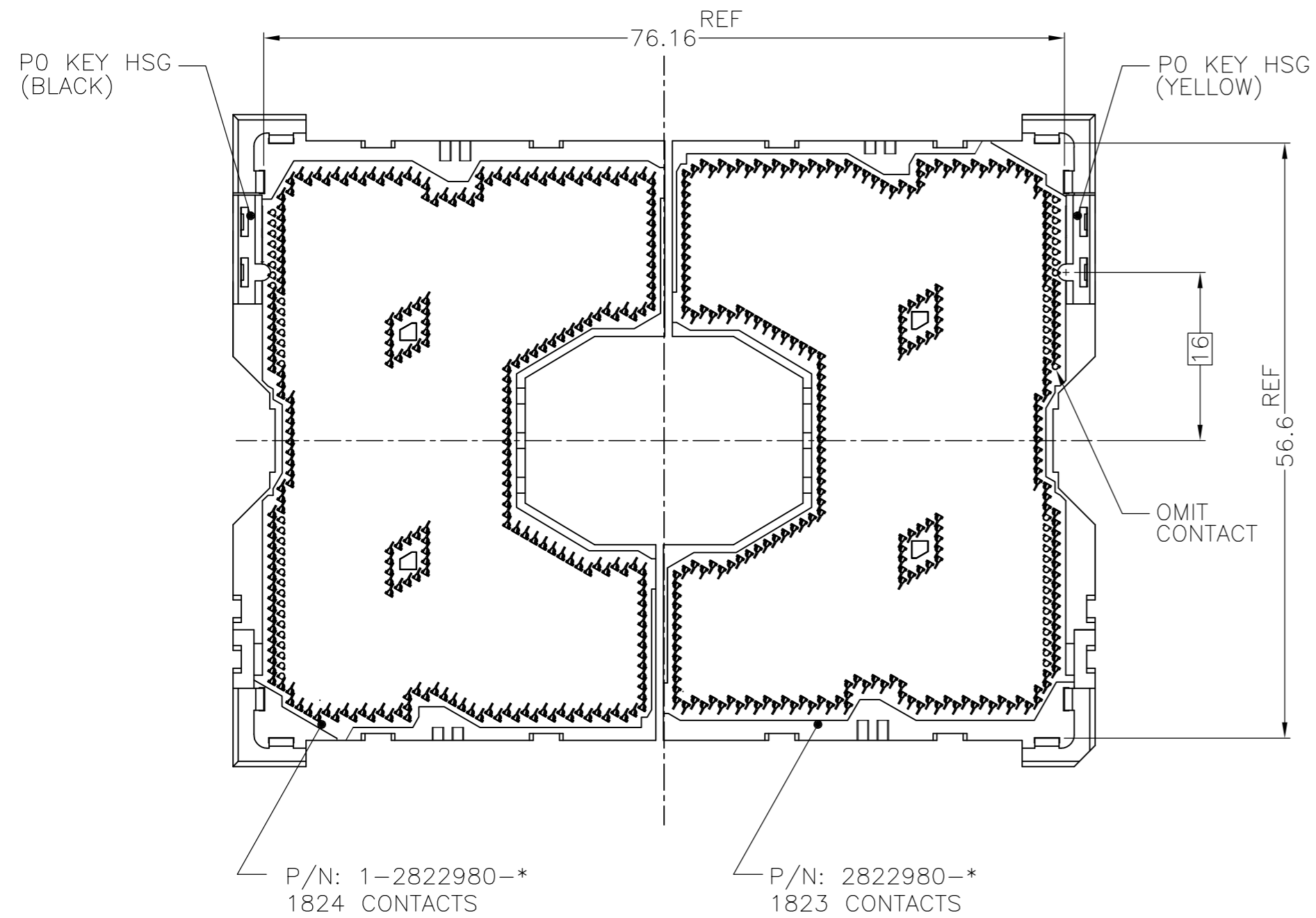

LGA3647-0 AS SHOWN  
(KIT P/N: 2-2822979-\*)

SOCKET P1,LGA3647-1 AS SHOWN

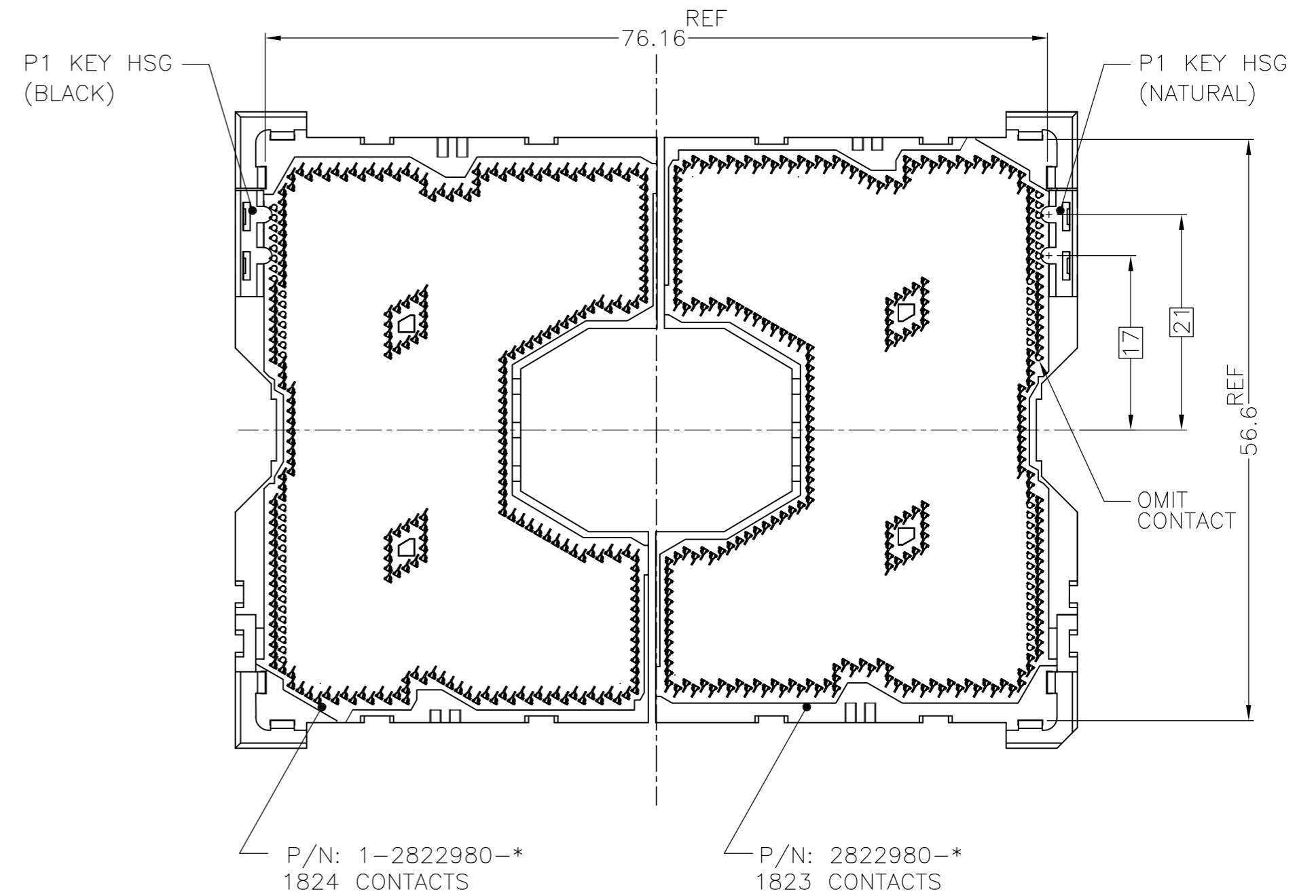

LGA3647-1 AS SHOWN  
(KIT P/N: 2-2822979-\*)

LGA3647-X POST SMT CONDITION  
(PCB IS NOT SHOWN)

THIS DRAWING IS A CONTROLLED DOCUMENT.		DWN	TE Connectivity		
DIMENSIONS: mm		CHK	NAME		
TOLERANCES UNLESS OTHERWISE SPECIFIED:		APVD	SOCKET ASSY LGA3647-X		
0-PLC ± 1-PLC ± ±0.3 2-PLC ± ±3 3-PLC ± ± 4-PLC ± ± ANGLES ± ± FINISH -		PRODUCT SPEC	SIZE	CAGE CODE	DRAWING NO
MATERIAL		APPLICATION SPEC	A2	00779	C=2129710
		WEIGHT	RESTRICTED TO		
		CUSTOMER DRAWING	SCALE	SHEET	REV
			NTS	6 of 7	C

THIS DRAWING IS UNPUBLISHED. RELEASED FOR PUBLICATION  
 © COPYRIGHT - Tyco Electronics JAPAN G.K. ALL RIGHTS RESERVED.

LOC		DIST		REVISIONS			
P	LTR	DESCRIPTION		DATE	DWN	APVD	
-	-	SEE SHEET 1		-	-	-	

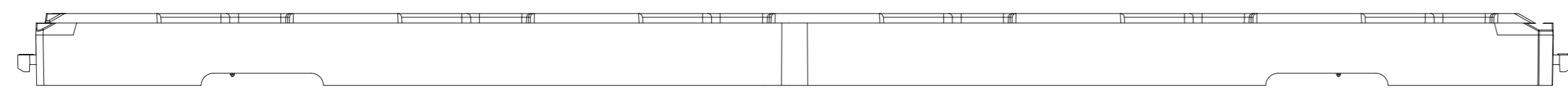
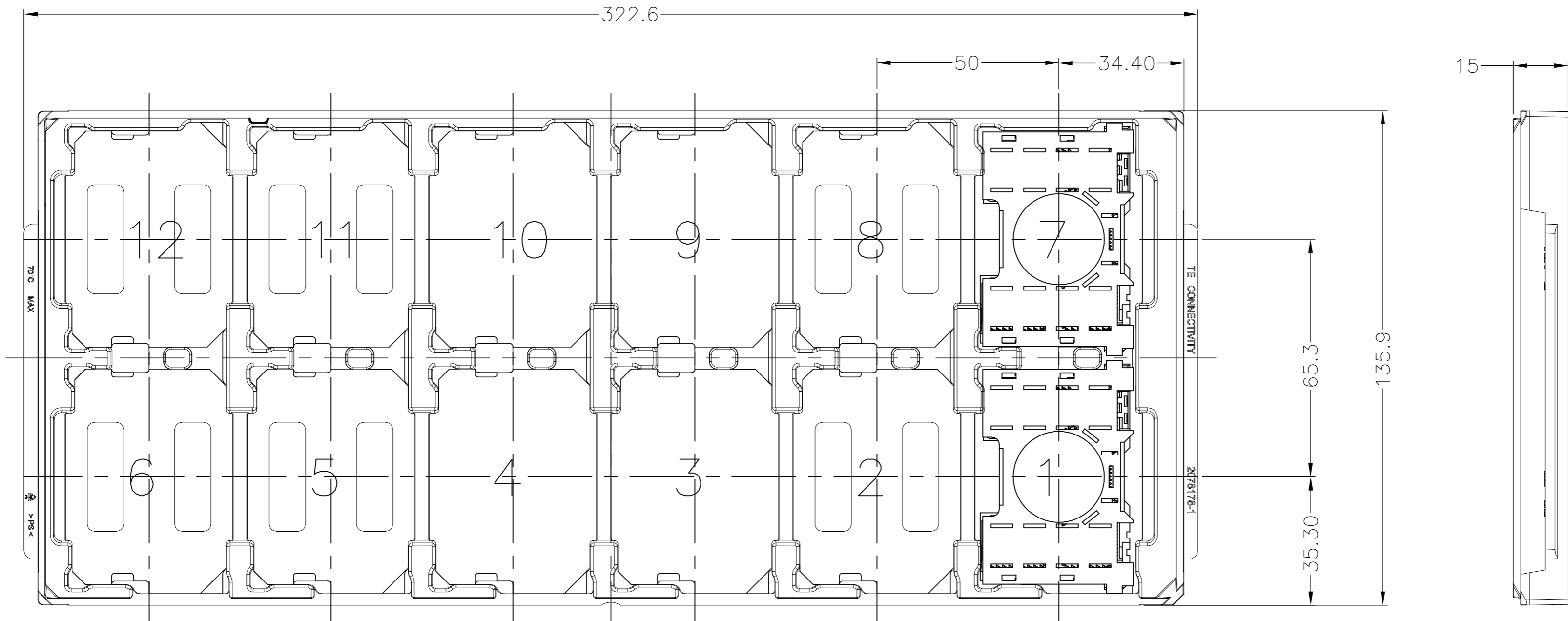

FOR LEFT SEGMENT, USE BLACK TRAY TO PACKAGE.  
 FOR RIGHT SEGMENT, USE BLUE TRAY TO PACKAGE.

168	84	12	2822980-4	2-2129710-8	LGA3647-1 RIGHT SEGMENT	LGA3647-1 SOCKET P1
168	84	12	1-2822980-4	2-2129710-7	LGA3647-1 LFFT SEGMENT	LGA3647-1 SOCKET P0
168	84	12	2822980-3	2-2129710-6	LGA3647-0 RIGHT SEGMENT	LGA3647-0 SOCKET P1
168	84	12	1-2822980-3	2-2129710-5	LGA3647-0 LFFT SEGMENT	LGA3647-0 SOCKET P0
168	84	12	2822980-2	2-2129710-4	LGA3647-1 RIGHT SEGMENT	LGA3647-1 SOCKET P1
168	84	12	1-2822980-2	2-2129710-3	LGA3647-1 LFFT SEGMENT	LGA3647-1 SOCKET P0
168	84	12	2822980-1	2-2129710-2	LGA3647-0 RIGHT SEGMENT	LGA3647-0 SOCKET P1
168	84	12	1-2822980-1	2-2129710-1	LGA3647-0 LFFT SEGMENT	LGA3647-0 SOCKET P0
SOCKET QTY PER OUTER BOX	SOCKET QTY PER INNER BOX	SOCKET QTY PER TRAY	ASSY PART NUMBER	ORDER PART NUMBER	PRODUCT NAME	

THIS DRAWING IS A CONTROLLED DOCUMENT.

DWN	-	 TE Connectivity SOCKET ASSY LGA3647-X	SIZE	A2	CAGE CODE	00779	DRAWING NO	C=2129710	RESTRICTED TO	-
CHK	-		SCALE	NTS	SHEET	7 of 7	REV	C		
APVD	-		CUSTOMER DRAWING							
PRODUCT SPEC	-									
APPLICATION SPEC	-									
WEIGHT	-									

## X-ON Electronics

Largest Supplier of Electrical and Electronic Components

*Click to view similar products for IC & Component Sockets category:*

*Click to view products by TE Connectivity manufacturer:*

Other Similar products are found below :

[0066-3-17-15-30-14-02-0](#) [670](#) [672](#) [673](#) [694-13-640-00-672-000](#) [712-93-120-41-001000](#) [714-93-104-31-018000](#) [8059-4G1-LF](#) [807-22-001-10-001101](#) [807-22-001-10-006101](#) [807-22-001-30-011101](#) [807-22-001-30-012101](#) [807-22-001-30-013101](#) [807-22-001-30-014101](#) [8-1437531-4](#) [8150-6P10](#) [833-93-034-10-001000](#) [851-41-006-10-001000](#) [851-43-008-20-001000](#) [851-43-014-20-001000](#) [851-93-006-20-001000](#) [851-93-010-20-001000](#) [853-43-020-10-001000](#) [86.010.0053.0](#) [116-43-308-41-007000](#) [PX-68LCC](#) [121-13-318-41-001000](#) [121-13-320-41-001000](#) [121-13-308-41-001000](#) [123-43-314-41-801000](#) [123-43-420-41-001000](#) [122-13-316-41-001000](#) [123-13-624-41-001000](#) [123-43-306-41-001000](#) [12-3513-11](#) [123-91-320-41-001000](#) [126-43-310-41-002000](#) [AKSUN 37V-T](#) [1437503-9](#) [1437504-1](#) [146-44-308-41-013000](#) [146-43-308-41-012000](#) [160-10-308-00-001000](#) [160-40-320-00-001000](#) [214-99-306-01-670800](#) [232-1270-02-0602](#) [2-382761-4](#) [2-5331677-4](#) [2-640360-3](#) [2801-2-00-50-00-00-07-0](#)