

THIS DRAWING IS UNPUBLISHED. RELEASED FOR PUBLICATION
 © COPYRIGHT - BY TYCO ELECTRONICS CORPORATION. ALL RIGHTS RESERVED.

LOC	DIST	REVISIONS					
		P	LTR	DESCRIPTION	DATE	DWN	APVD
H	-		A	RELEASED FOR PRODUCTION	24OCT2016	RK	MvE
			A1	CHANGED LASER MARKING	03NOV2016	RK	MvE
			A2	CHANGED LASER MARKING	07MAR2017	RK	MvE
			B	ECR-17-008373	16OCT2017	RK	PO

DIMENSIONS BEFORE APPLICATION

NOTES:

- 2213600-1 AS SHOWN.
- MATERIALS:

CONTACT: PHOSPHOR BRONZE, TIN PLATED
 HOUSING: PC NOT GLASS FILLED
 BUTTONS: PC NOT GLASS FILLED

- 3 LASER MARKING:
- KEMA
 - UL
 - TE LOGO
 - TE PART NUMBER
 - DATE CODE

4 LASER MARKING: IP20

5 LASER MARKING: IP x5/x7

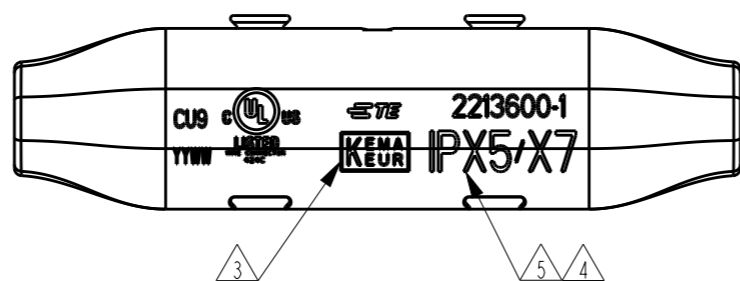
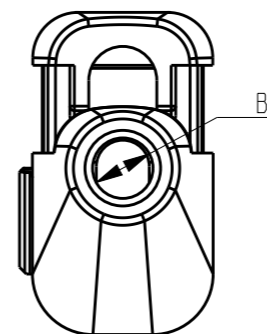
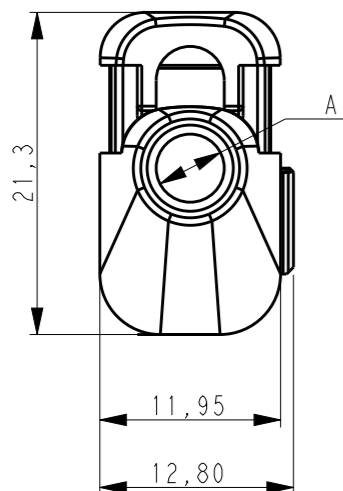
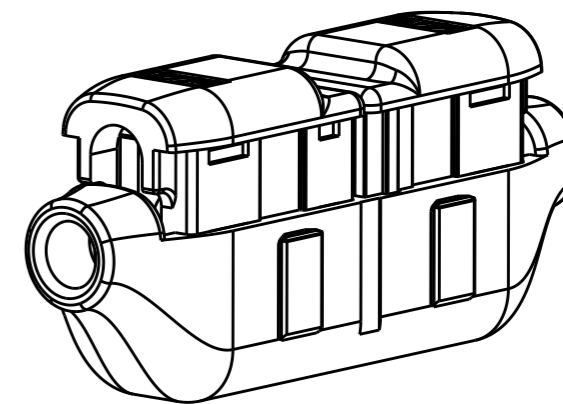
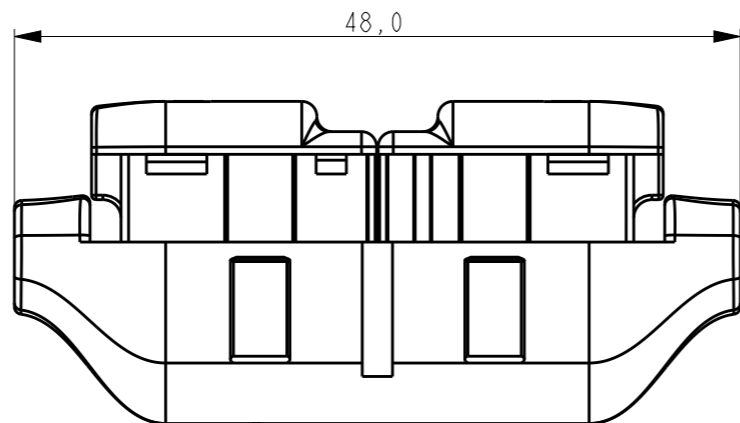
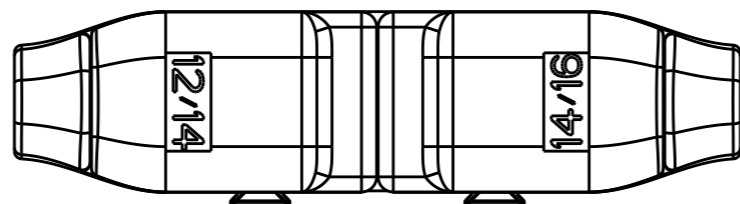

STANDARD	4	A=3.5 B=3.5	16/18 TO 16/18	RED AND RED	CLEAR	1-2213600-0
STANDARD	4	A=4.5 B=4.5	12/14 TO 12/14	YELLOW AND YELLOW	CLEAR	2213600-9
SEALED	5	A=3.5 B=3.5	16/18 TO 16/18	RED AND RED	CLEAR	2213600-8
SEALED	5	A=4.5 B=4.5	12/14 TO 12/14	YELLOW AND YELLOW	CLEAR	2213600-7
STANDARD	4	A=4.0 B=3.5	14/16 TO 16/18	BLUE AND RED	CLEAR	2213600-6
STANDARD	4	A=4.5 B=3.5	12/14 TO 16/18	YELLOW AND RED	CLEAR	2213600-5
STANDARD	4	A=4.5 B=4.0	12/14 TO 14/16	YELLOW AND BLUE	CLEAR	2213600-4
SEALED	5	A=4.0 B=3.5	14/16 TO 16/18	BLUE AND RED	CLEAR	2213600-3
SEALED	5	A=4.5 B=3.5	12/14 TO 16/18	YELLOW AND RED	CLEAR	2213600-2
SEALED	5	A=4.5 B=4.0	12/14 TO 14/16	YELLOW AND BLUE	CLEAR	2213600-1
SEALING		WIRE ENTRY	WIRE SIZE	BUTTON COLORS	HOUSING COLOR	PART NUMBER

THIS DRAWING IS A CONTROLLED DOCUMENT. DIMENSIONING AND TOLERANCING PER ASME Y14.5M-2009.		DWN M.V.ESSEN 06 NOV '15	TE Connectivity	
DIMENSIONS: mm		CHK C.V.STEENDEREN		
TOLERANCES UNLESS OTHERWISE SPECIFIED:		APVD O.I.FIJNSE	NAME COOL SPLICE ONE POSITION LARGE WIRE GAUGE	
0 PLC ±- 1 PLC ±0,2 2 PLC ±0,2 3 PLC ±- 4 PLC ±- ANGLES ±-		PRODUCT SPEC 108-133061	SIZE A3	
MATERIAL -		APPLICATION SPEC 114-133061	CAGE CODE 00779	DRAWING NO C-2213600
FINISH -		WEIGHT -	RESTRICTED TO -	
		CUSTOMER DRAWING	SCALE 2:1	SHEET 1 OF 3
			REV C2	

THIS DRAWING IS UNPUBLISHED.

RELEASED FOR PUBLICATION



© COPYRIGHT - BY TYCO ELECTRONICS CORPORATION. ALL RIGHTS RESERVED.

LOC	DIST	REVISIONS					
		P	LTR	DESCRIPTION	DATE	DWN	APVD
		-		SEE SHEET 1	-	-	-

DIMENSIONS AFTER APPLICATION

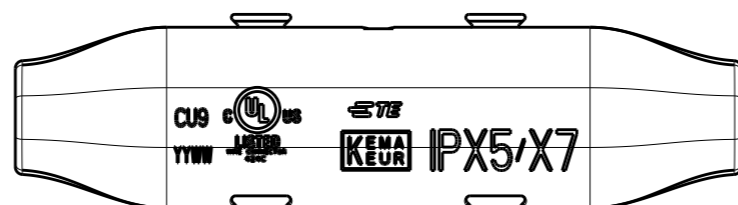
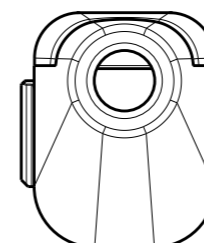
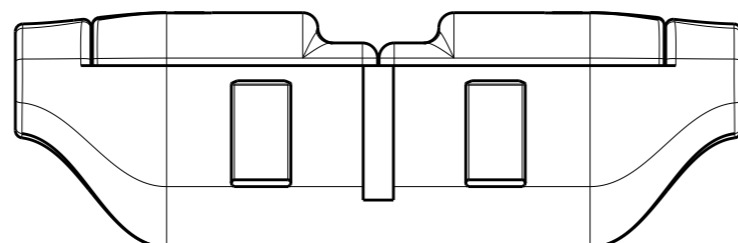
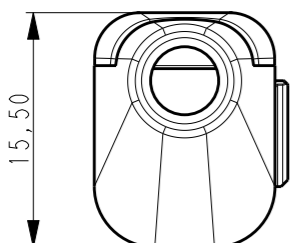
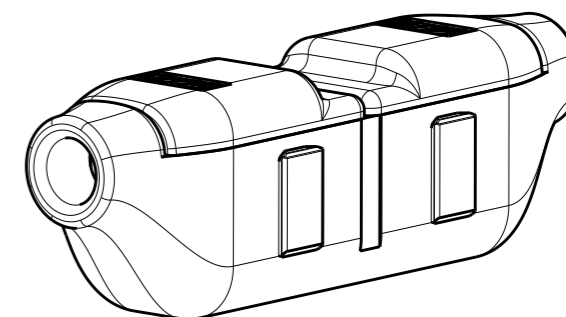
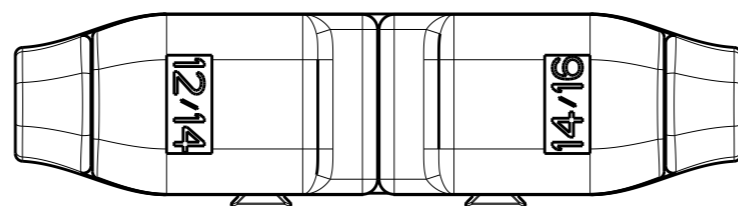
NOTE:
1. 2213600-1 AS SHOWN.



THIS DRAWING IS A CONTROLLED DOCUMENT.		DWN M.V.ESSSEN	06 NOV'15	 TE Connectivity	
DIMENSIONS: mm		CHK C.V.STEENDEREN	-		
		APVD O.I.FIJNSE	-	NAME COOL SPLICE ONE POSITION LARGE WIRE GAUGE	
TOLERANCES UNLESS OTHERWISE SPECIFIED:		PRODUCT SPEC 108-133061		SIZE A3	
0 PLC ±-		APPLICATION SPEC 114-133061		CAGE CODE 00779	DRAWING NO C-2213600
1 PLC ±0,2		WEIGHT -		RESTRICTED TO -	
2 PLC ±0,2		CUSTOMER DRAWING		SCALE 1:1	SHEET 2 OF 3
3 PLC ±-				REV C2	
4 PLC ±-					
ANGLES ±-					
FINISH -					

THIS DRAWING IS UNPUBLISHED.

RELEASED FOR PUBLICATION

© COPYRIGHT - BY TYCO ELECTRONICS CORPORATION. ALL RIGHTS RESERVED.

LOC DIST

REVISIONS

P	LTR	DESCRIPTION	DATE	DWN	APVD
-	-	SEE SHEET 1	-	-	-

DIMENSIONS AFTER STACKING

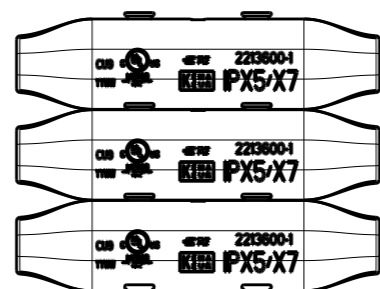
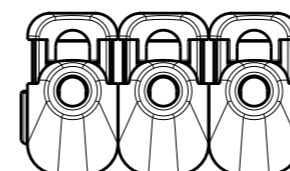
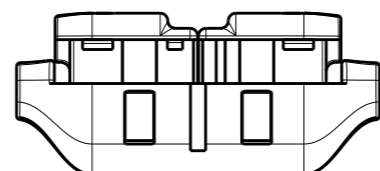
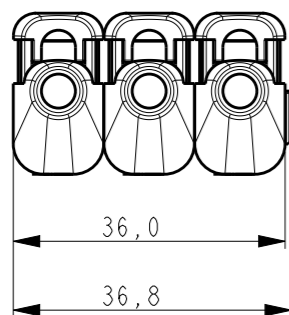
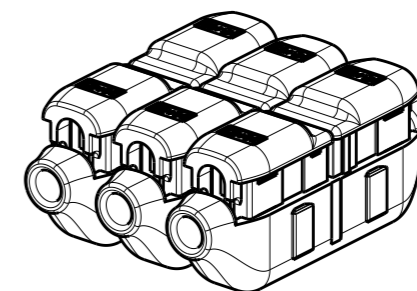
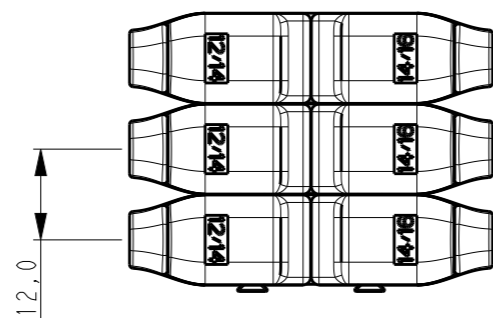

THIS DRAWING IS A CONTROLLED DOCUMENT.

DIMENSIONS:
mm

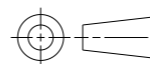

TOLERANCES UNLESS OTHERWISE SPECIFIED:

0 PLC	±-
1 PLC	±0,2
2 PLC	±0,2
3 PLC	±-
4 PLC	±-
ANGLES	±-

MATERIAL

FINISH

DWN 06 NOV'15

M.V.ESSEN

CHK

C.V.STEENDEREN

APVD

O.I.FIJNSE

PRODUCT SPEC

108-133061

APPLICATION SPEC

114-133061

WEIGHT

-

CUSTOMER DRAWING



TE Connectivity

NAME

COOL SPLICE
ONE POSITION LARGE WIRE GAUGE

SIZE

A3

CAGE CODE

00779

DRAWING NO

C-2213600

RESTRICTED TO

-

SCALE 1:1

SHEET 3 OF 3

REV C2

X-ON Electronics

Largest Supplier of Electrical and Electronic Components

Click to view similar products for [Terminals](#) category:

Click to view products by [TE Connectivity](#) manufacturer:

Other Similar products are found below :

[00-054007-01074-6](#) [00-054007-70206-1](#) [00-054007-70210-8](#) [00-054007-70217-7](#) [00-054007-70226-9](#) [00-054007-70228-3](#) [00-054007-70248-1](#) [00-054007-70256-6](#) [00-054007-70301-3](#) [00-054007-70316-7](#) [00-054007-49560-4](#) [00-054007-70209-2](#) [00-054007-70225-2](#) [00-054007-70227-6](#) [00-054007-70231-3](#) [00-054007-70241-2](#) [00-054007-70242-9](#) [00-054007-70244-3](#) [00-054007-70246-7](#) [00-054007-70263-4](#) [00-054007-70288-7](#) [00-054007-70290-0](#) [00-054007-70300-6](#) [00-054007-70304-4](#) [01-2065-1-0216](#) [01-2900-1-04412](#) [00581P0075](#) [600TS-10](#) [60205-1](#) [604200-1](#) [605601-1](#) [60598-1-CUT-TAPE](#) [61314-6-C](#) [61810-3](#) [61-S](#) [61-SN](#) [626-0194](#) [62-NBM-A](#) [62-SN](#) [62-SP](#) [63-S](#) [640179-1](#) [M55155/059I03](#) [M55155/079C01](#) [M55155/099H02](#) [M55155/109H01](#) [M55155/109H02](#) [M55155/12XH05](#) [M55155/16XH02](#) [M55155/29-5S](#)