

LOC	DIST	REVISIONS					
		P	LTN	DESCRIPTION	DATE	DWN	APVD
AA	00	A		FIRST RELEASE	01AUG2016	SZ	SZ
		A1		ECO-17-002319	20FEB2017	SZ	SZ
		A2		ECO-18-018908	03DEC2018	SZ	SZ

- MATERIAL: HOUSING - PBT, THERMOPLASTIC, GLASS REINFORCED, COLOR: BLACK, CONTACT - COPPER ALLOY
- FINISH: CONTACT - GOLD PLATED OVER NICKEL, SOLDER TAILS - MATTE TIN OVER NICKEL
- CONNECTOR ASSEMBLY MARKED WITH PART NUMBER AND DATE CODE IN THE APPROXIMATE AREA SHOWN
- DATUMS AND BASIC DIMENSIONS TO BE ESTABLISHED BY CUSTOMER
- MANUFACTURING TOLERANCE FOR 1.07mm DIAMETER FINISHED HOLE:
 DRILLED HOLE = 1.20+/-0.03mm
 COPPER PLATE = 0.025-0.050mm (MAX HARDNESS 150 KNOOP)
 TIN/LEAD PLATE (HASL) = 0.010/0.004mm
- MANUFACTURING TOLERANCE FOR 0.70mm DIAMETER FINISHED HOLE:
 DRILLED HOLE = 0.78+/-0.03mm
 COPPER PLATE = 0.025-0.050mm (MAX HARDNESS 150 KNOOP)
 TIN/LEAD PLATE (HASL) = 0.010/0.004mm
- CUSTOMIZED SEATING TOOL IS REQUIRED TO INSTALL CONNECTORS CORRECTLY ONTO PC BOARD.

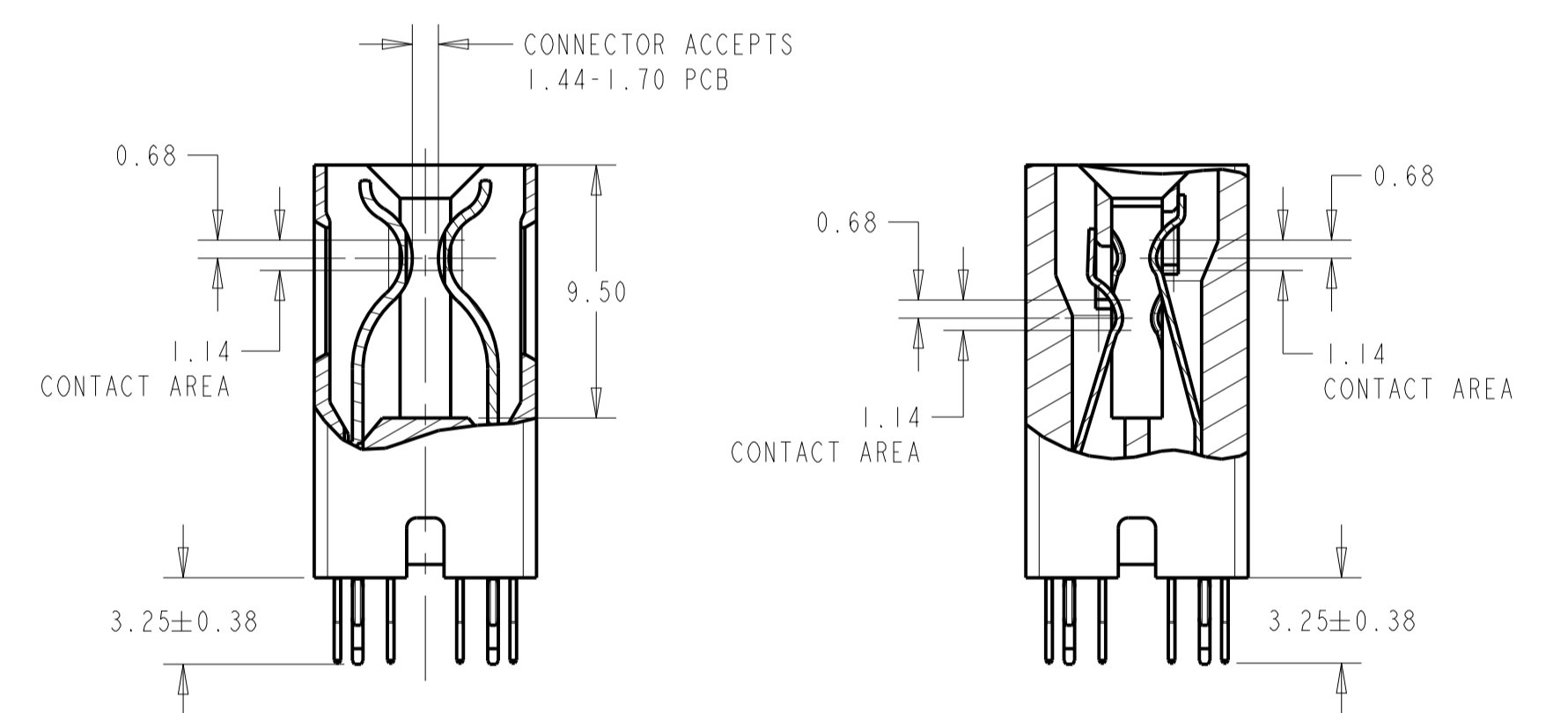

2214913-1 SHOWN

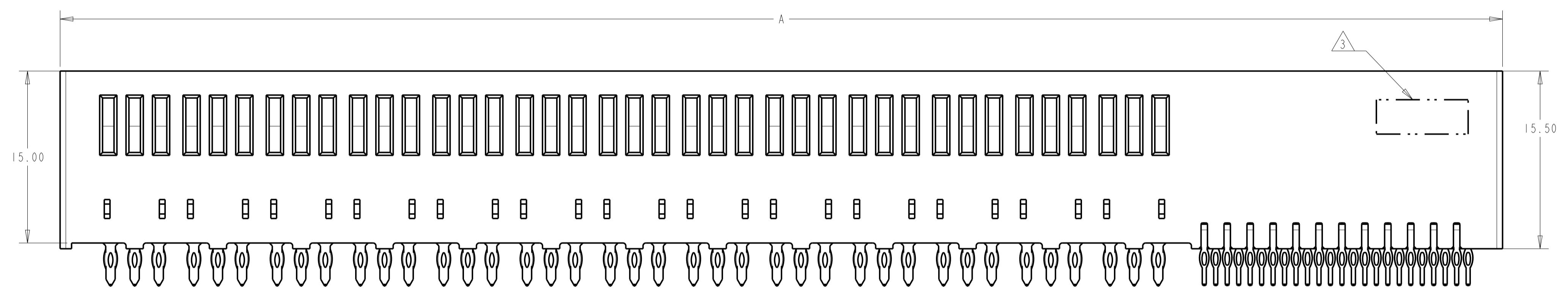
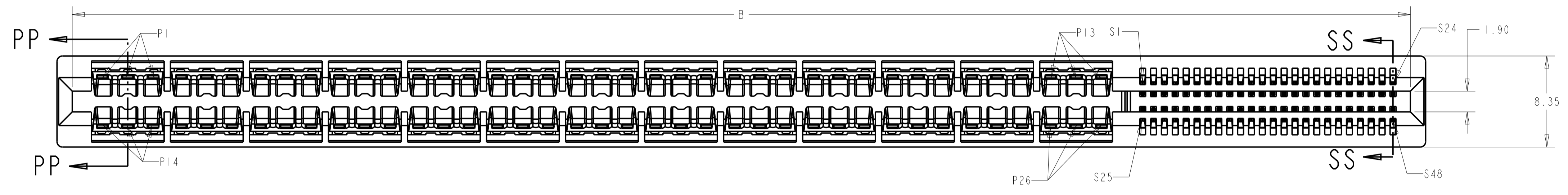
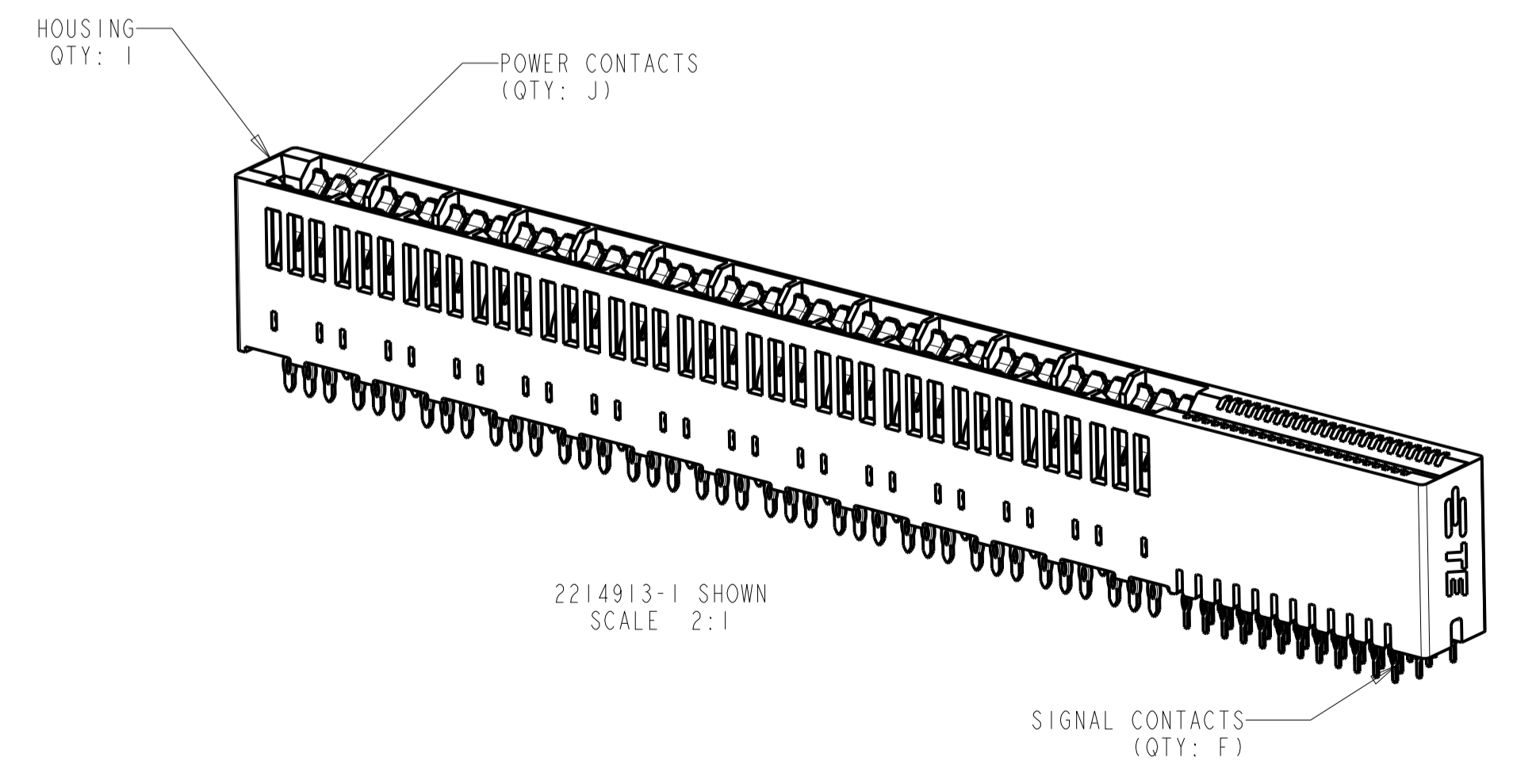

7.44	24.76	6	10.93	4.41	4	18.37	8	12	10	12	2	25.07	27.87	2 X 2 POWER 2 X 6 SIGNAL	2214913-7
19.33	48.54	8	22.82	14.30	10	42.15	20	16	8	30	8	48.85	51.65	2 X 5 POWER 2 X 8 SIGNAL	2214913-6
13.70	37.28	4	17.19	12.675	8	30.89	16	8	6	24	6	37.59	40.39	2 X 4 POWER 2 X 4 SIGNAL	2214913-5
24.96	59.80	12	28.45	15.935	12	53.41	24	24	22	36	10	60.11	62.91	2 X 6 POWER 2 X 12 SIGNAL	2214913-4
15.70	41.28	8	19.19	10.675	8	34.89	16	16	14	24	6	41.59	44.39	2 X 4 POWER 2 X 8 SIGNAL	2214913-3
6.44	22.76	4	9.93	5.415	4	16.37	8	8	6	12	2	23.07	25.87	2 X 2 POWER 2 X 4 SIGNAL	2214913-2
56.37	122.62	24	59.86	35.345	26	116.23	52	48	46	78	24	122.93	125.73	2 X 13 POWER 2 X 24 SIGNAL	2214913-1
P	N	M	L	K	J	H	G	F	E	D	C	B	A	DESCRIPTION	PART NUMBER

THIS DRAWING IS A CONTROLLED DOCUMENT.

DIMENSIONS: mm
 TOLERANCES UNLESS OTHERWISE SPECIFIED:
 0 PLC ±0.25
 1 PLC ±0.5
 2 PLC ±0.25
 3 PLC ±0.25
 4 PLC ±0.25
 ANGLES ±0.1°

MATERIAL: SEE NOTE 1
 FINISH: SEE NOTE 2

DWN: L.A. WENSEL 05APR2012
 CHK: D. DEFIBAUGH 05APR2012
 APVD: S. ELICKINGER 05APR2012

NAME: CONNECTOR ASSEMBLY, MULTI-BEAM CE, POWER/SIGNAL, VERTICAL, EYE OF THE NEEDLE
 SIZE: A1
 CAGE CODE: 00779
 DRAWING NO: 2214913
 SCALE: 4:1
 SHEET 1 OF 2
 REV: A2

CUSTOMER DRAWING
 SCALE: 4:1
 SHEET 1 OF 2
 REV: A2

LOC	DIST	REVISIONS			
		REV	DATE	BY	APPV
AA	00	1	SEE SHEET 1		

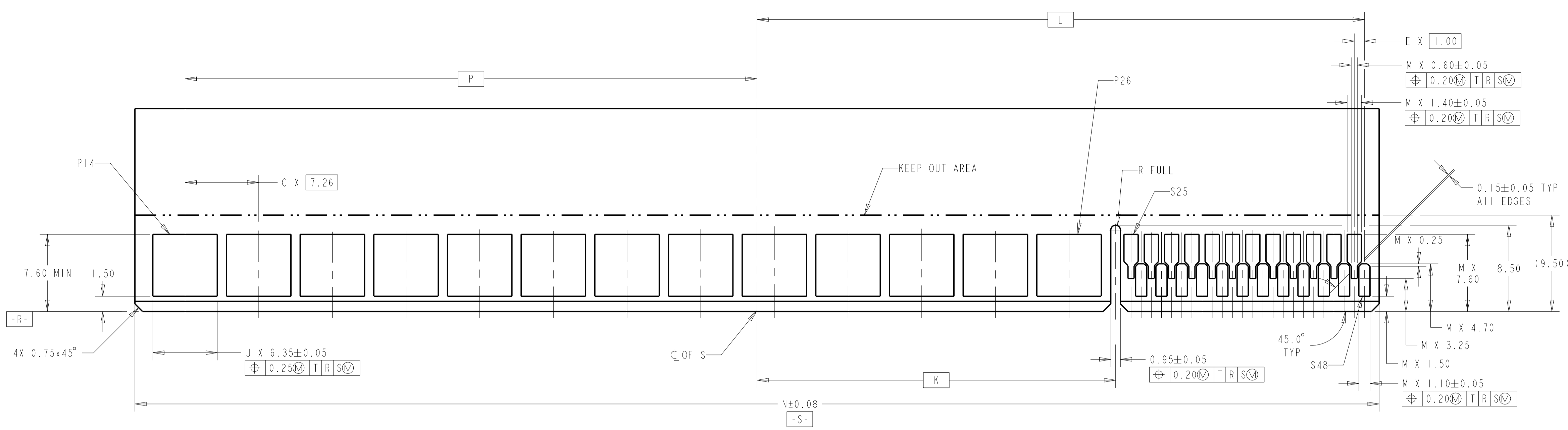

RECOMMENDED MATING BOARD EDGE CONFIGURATION
 (PRIMARY SIDE SHOWN)
 2214913-1 DAUGHTER CARD

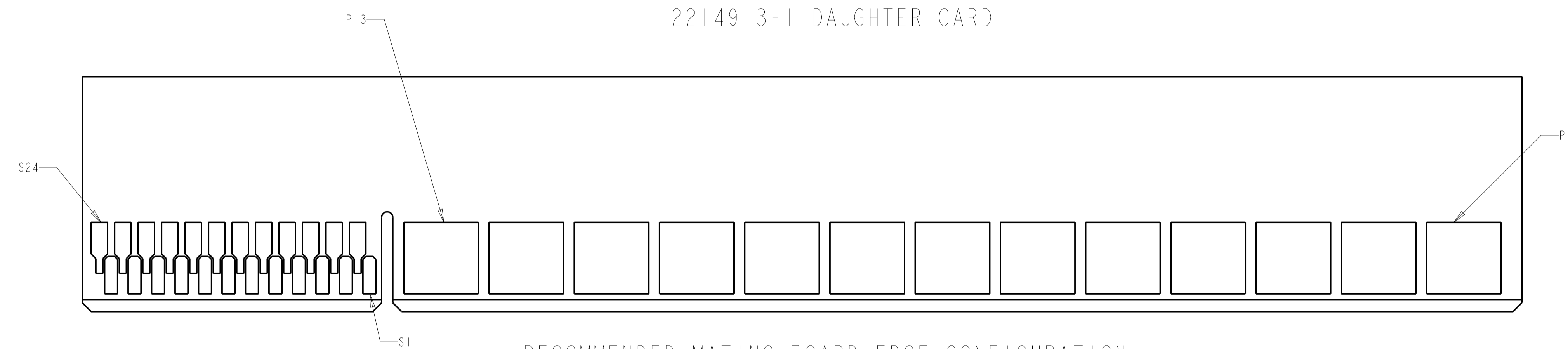
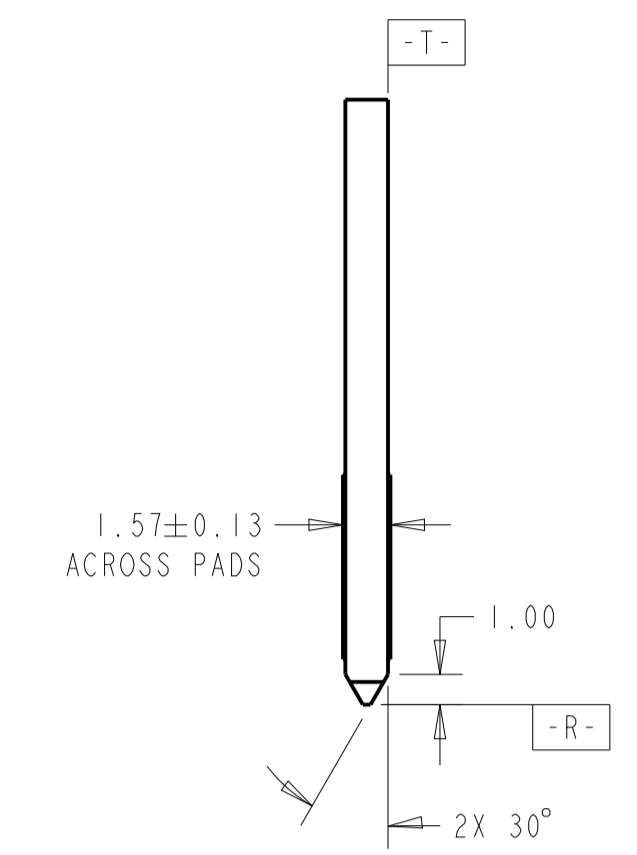

RECOMMENDED MATING BOARD EDGE CONFIGURATION
 (SECONDARY SIDE SHOWN)

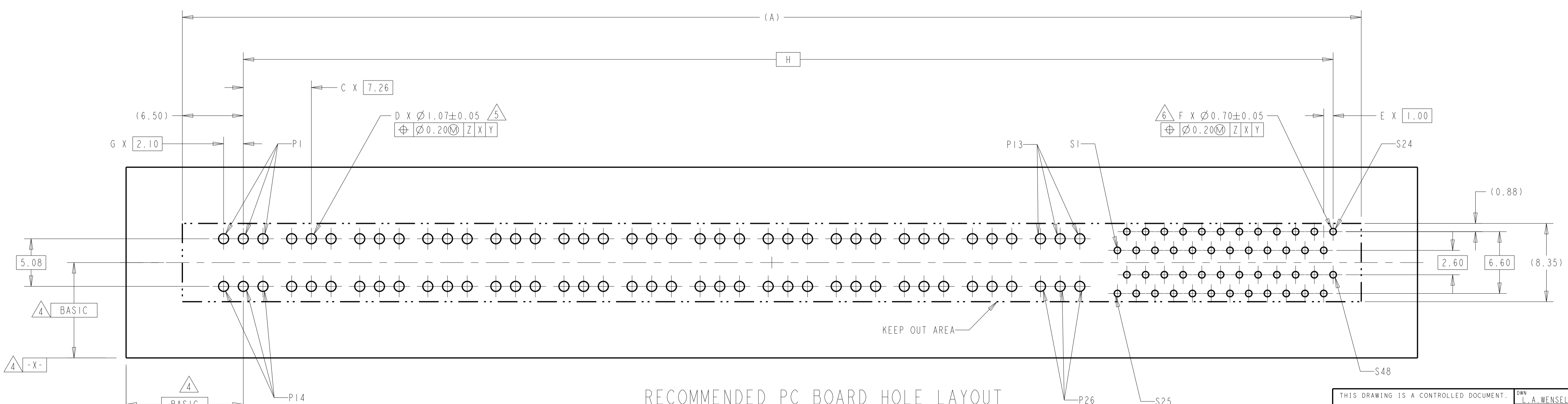

RECOMMENDED PC BOARD HOLE LAYOUT
 COMPONENT SIDE
 2214913-1 LAYOUT

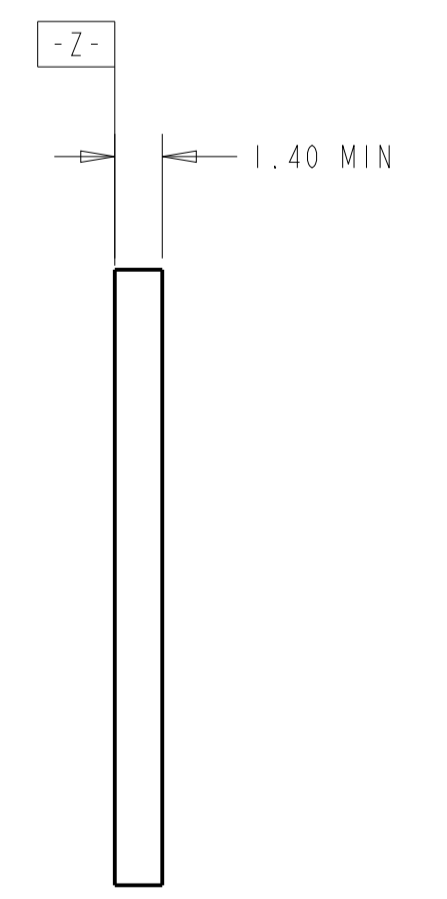

THIS DRAWING IS A CONTROLLED DOCUMENT.		OWN L.A.WENSEL 05APR2012	TE Connectivity								
DIMENSIONS: mm		CHK D.DEFIRAUGH 05APR2012									
TOLERANCES UNLESS OTHERWISE SPECIFIED:		APVD S.FELICKINGER 05APR2012	NAME CONNECTOR ASSEMBLY, MULTI-BEAM CE, POWER/SIGNAL, VERTICAL, EYE OF THE NEEDLE								
<table border="1"> <tr><td>0 PLC</td><td>±</td></tr> <tr><td>1 PLC</td><td>±0.3</td></tr> <tr><td>3 PLC</td><td>±0.13</td></tr> <tr><td>4 PLC</td><td>±</td></tr> </table>		0 PLC	±	1 PLC	±0.3	3 PLC	±0.13	4 PLC	±	PRODUCT SPEC	RESTRICTED TO
0 PLC	±										
1 PLC	±0.3										
3 PLC	±0.13										
4 PLC	±										
MATERIAL SEE NOTE 1		APPLICATION SPEC	SIZE A1								
FINISH SEE NOTE 2		WEIGHT	CAGE CODE 00779								
CUSTOMER DRAWING		SCALE 1:1	SHEET 2 OF 2								

X-ON Electronics

Largest Supplier of Electrical and Electronic Components

Click to view similar products for [Power to the Board](#) category:

Click to view products by [TE Connectivity](#) manufacturer:

Other Similar products are found below :

[6450171-4](#) [6450552-7](#) [6600323-8](#) [6643429-1](#) [6646040-2](#) [6651939-1](#) [6766604-1](#) [120959-1](#) [1393557-2](#) [1393532-2](#) [1393532-3](#) [1393532-4](#)
[1393557-1](#) [1600812-5](#) [1-6450861-2](#) [1744132-7](#) [1761122-1](#) [1766250-1](#) [1892109-1](#) [2-6450860-5](#) [2-6450870-0](#) [1-6450161-4](#) [1-6450850-6](#) [1-6450869-6](#) [1645526-2](#) [1-6600130-0](#) [2005243-2](#) [377-0020-11130](#) [TE34-12-16P-F0](#) [5-6450830-6](#) [5646956-4](#) [377-0080-11131A](#) [4-6450830-9](#)
[4-6600333-3](#) [10125416-4050LF](#) [6600320-3](#) [3-6450860-5](#) [1888123-2](#) [6450166-1](#) [6643978-1](#) [6766605-1](#) [701-15-02109](#) [N11444](#) [6651938-1](#)
[6450810-7](#) [46437-1112](#) [1-1589677-8](#) [5646956-5](#) [6450813-2](#) [6450129-4](#)