



NOTE

All numerical values are in metric units [with U.S. customary units in brackets]. Dimensions are in millimeters [and inches]. Unless otherwise specified, dimensions have a tolerance of ± 0.13 [$\pm .005$] and angles have a tolerance of $\pm 2^\circ$. Figures and illustrations are for identification only and are not drawn to scale.

1. INTRODUCTION

This specification covers the requirements for application of the Snap-Lug Quick Disconnect Power Connector. These connectors are single-pole quick-connect/disconnect bus bar connectors used in bus bar and power distribution applications. The connectors are designed to be used where standard terminal lugs with wire sizes of 4, 1/0, 2/0, and 3/0 AWG.

The high power connectors are available in silver finished male post contacts and tin finished female socket contacts as well as four color coding options to confirm polarity. The connector design will reduce the labor during assembly and enable faster system maintenance. The connector design features a positive latching mechanism with an audible “click” sound and tactile feel to confirm a full mate.

The socket contact is a right-angle configuration consisting of a housing and latch subassembly and a conductive socket contact body with a LOUVERTAC contact band with silver finish. The post contact features a keying ring and a socket latching feature on top of the post contact. The keying ring and the socket housings are available in red and black. Contact TE for other colors for polarity requirements.

The socket contact will accept MS22759 or equivalent standard wire sizes 4, 1/0, 2/0, and 3/0 AWG or nonmilitary wire with equivalent CMA, with 4 indent crimp termination tooling. See Figure 2. If nonmilitary wire is used in the application, the performance may vary from the design intent per Product Specification 108-32083.

A heat shrink boot or a heat shrink tubing shall be used to secure the housing and wire together for insulation and strain relief. Heat shrink tubing and boots are determined by the customer’s requirements. Examples of common heat shrink tubing and boots are as follows. More details are available at TE.com. Higher temperature options: DR-25 (150°C), RT555 (200°C), RT-780 (175°C), or RT-790 (200°C). Lower temperature options: ATUM-24/8, ATUM-24-6, or TAT-125. Dual Wall ATUM 24/8, ATUM 24/6 or TAT-125, all 110°C rated. Boot options: 202D221-3 with 202D221-25, or 202G621-55.

When corresponding with TE Connectivity Personnel, use the terminology provided in this specification to facilitate inquiries for information. Basic terms and features of this product are provided in Figure 1.

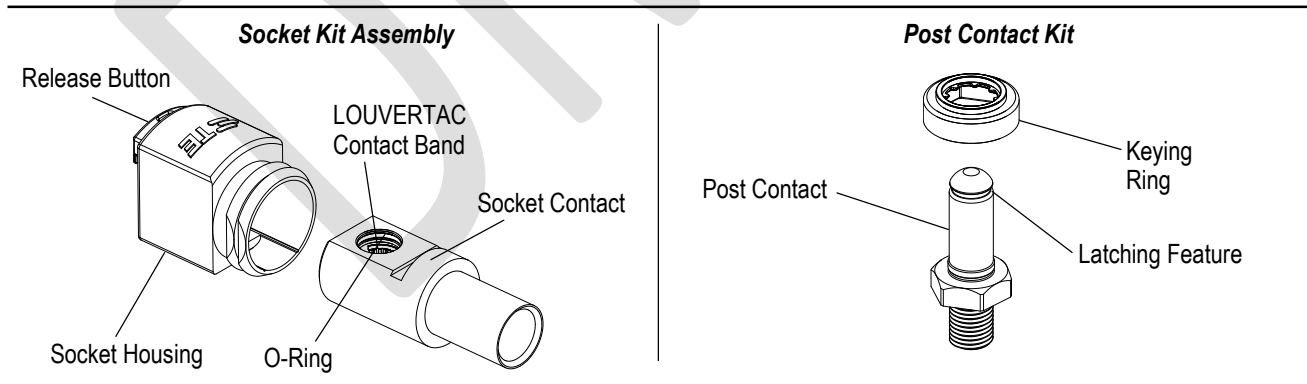

Figure 1

2. REFERENCE MATERIAL

2.1. Revision Summary

Initial release of application specification

2.2. Customer Assistance

Reference Product Base Part Numbers 2226934, 2226742, 2828522, and Product Code EE14 are representative of the Snap-Lug Power Connector. Use of these numbers will identify the product line and help you to obtain product and tooling information. Such information can be obtained through a local TE Representative, by visiting our website at www.te.com, or by calling PRODUCT INFORMATION at the number at the bottom of page 1.

2.3. Drawings

Customer Drawings for product part numbers are available from our website at www.te.com. If there is a conflict between the information contained in the Customer Drawings and this specification or with any other technical documentation supplied, the information contained in the Customer Drawings takes priority.

2.4. Specifications

Product Specification [108-32083](#) provides product performance and test results.

3. REQUIREMENTS

3.1. Safety

1. Do not stack product shipping containers so high that the containers buckle or deform.
2. Safety interlocks and/or insulating devices must be designed into the system to avoid inadvertent electrical shock.
3. Applying current loads higher than the recommended values in the 108-32083 can cause the product to not perform as designed.



DANGER

To avoid personal injury, the electrical system must be de-energized before installing or removing any connector and before mounting or removing connectors from the bus bar or backplane.

3.2. Storage

A. Ultraviolet Light

Prolonged exposure to ultraviolet light may deteriorate the chemical composition used in the product material.

B. Shelf Life

The product should remain in the shipping containers until ready for use to prevent deformation to components. The product should be used on a first in, first out basis to avoid storage contamination that could adversely affect performance.

C. Chemical Exposure

Do not store product near any chemical listed below as they may cause stress corrosion cracking in the material.

Alkalies	Ammonia	Citrates	Phosphates	Citrates	Sulfur Compounds
Amines	Carbonates	Nitrites	Sulfur Nitrites		Tartrates

3.3. Wire Selection

The socket contact accepts stranded copper wire sizes listed in Figure 2 and shall be MS22759/2 conductor strand count and AWG or equivalent.

CONDUCTOR SIZE (AWG)	SOCKET CONTACT KIT	MAX CURRENT AT 30°C T-Rise (AMPS)	STRIP LENGTH ±1.27 [.050]	MAX STRANDED CONDUCTOR DIA	PICO CRIMP TOOL	LOCATOR	CRIMP HEAD TOOL PART NUMBER	DIE CLOSURE DIMENSION
4	2226934	80	21.59 [.850]	7.00 [.275]	500-D-EC	10344	514DA-6934	5.84 [.230]
1/0	2226742	150	24.13 [.950]	12.06 [.475]		10345	514DA-6742	6.60 [.260]
2/0		200		14.6 [.575]			514DA-6743	7.62 [.300]
3/0	2828522	250						

i NOTE
Refer to 108-32083 for max current rating curves. If there is any conflict between the information contained in the 108-32083 and this specification or with any other technical documentation supplied, the information contained in the 108-32083 takes priority.
The crimp termination and performance will meet or exceed MIL-C-22520 requirements.
Figure 2

Pico is a trademark.

3.4. Installation Procedures

Select the conductor size and choose the contact kit according to the application.

A. Wire Preparation

Strip the conductor to the dimension given in the table in Figure 2. Ensure that the wire ends are straight and flat before installing into the crimp barrel of the contact. See Figure 3.

i NOTE
Carefully examine stripped wire to ensure all conductor strands are present prior to crimp operation.

! CAUTION
Avoid nicking or cutting the conductors. Laser stripping is recommended to avoid damage to the individual conductors.

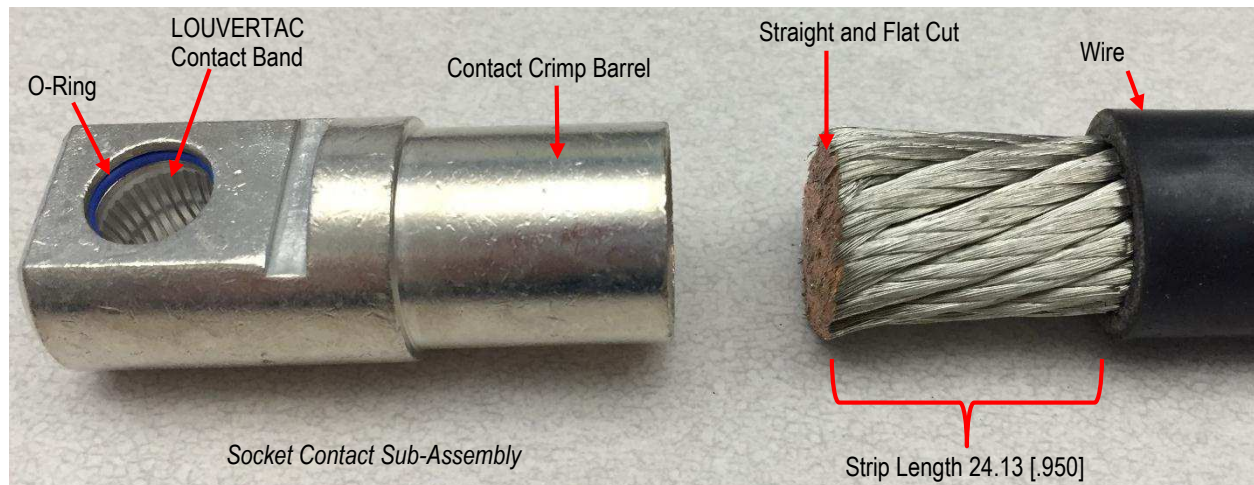

NOTE: 3/0 Socket Contact Body Shown

Figure 3

B. Contact Crimp Termination

1. Choose the crimp die and locator according to the conductor selection in Figure 2.
2. Assemble the locator and crimp die into the Pico crimp tool.
3. Insert the conductor into the contact crimp barrel until it stops against the bottom of the crimp barrel.
4. Be sure the conductor is fully installed in the crimp barrel
5. Insert the contact body and conductor into the crimp die and locator as show in Figure 4.

Pico is a trademark.

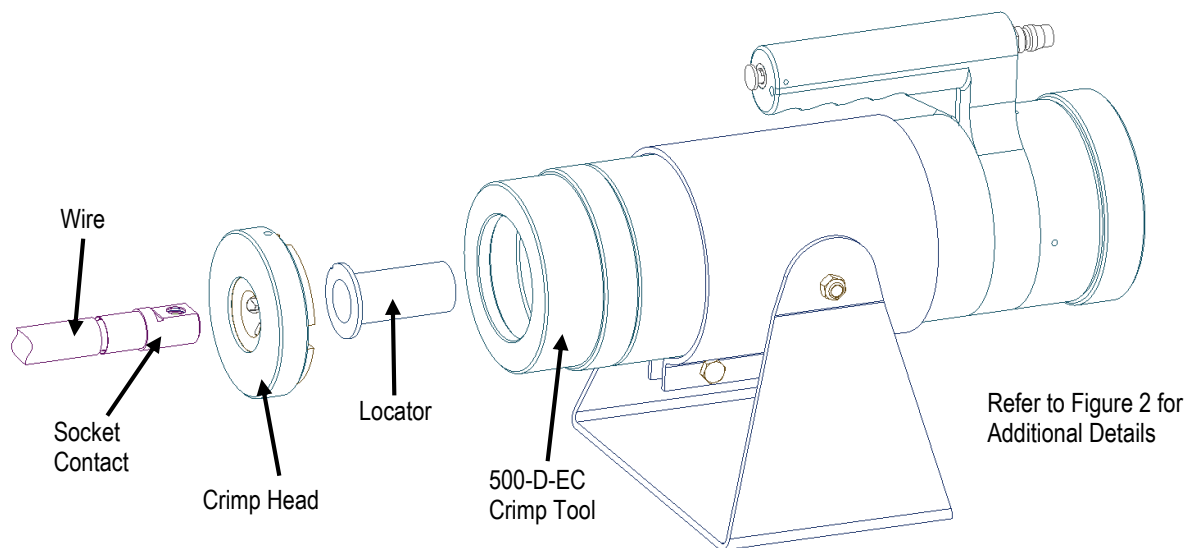

Figure 4

6. Hold the wire into the socket contact firmly and cycle the crimp tool when the contact and conductor is fully bottomed in the locator. Refer to Figure 5 for example after crimp operation. The crimp indent location must be centered in the crimp barrel.

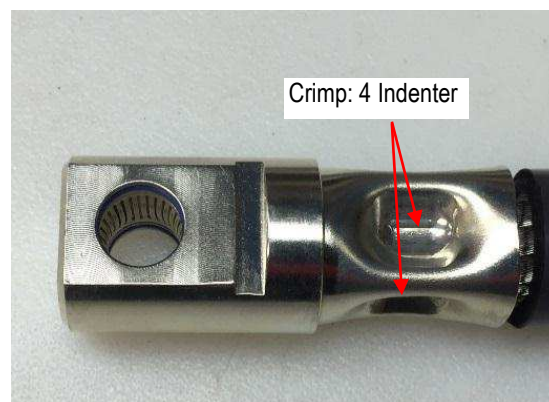

Figure 5

C. Crimp Inspection (Figure 6)

SOCKET CONTACT WIRE SIZE (AWG)	WIRE SIZE (AWG)	TENSILE STRENGTH (lbs) (MIL-C-39029)	CRIMP HEIGHT (in.) (REF ONLY)
4	4	400	.244
1/0-2/0	1/0	700	.296
	2/0	750	.305
3/0	3/0	825	.353

NOTE: Crimp heights can vary depending on the wire selected for the application. Therefore, the above crimp height data should only be used as a reference.

Figure 6

3.5. Housing and Contact Assembly

A. Heat Shrink Tubing

The minimum cut length of shrink tubing is 63.5 mm [2.50 in.]. The heat shrink tubing is to cover and support the connector, the crimp area, and the wire.

Dual or single wall heat shrink tubing may be used. If a single wall tubing is used, it is recommended to use adhesive under the heat shrink tubing. The adhesive can be in a paste epoxy form or an adhesive tape. For adhesive selection information see TE Adhesive Installation Guide 2-1773464-2 or contact your local TE Sales Rep. or Field Application Engineer.

B. Procedure

1. Slide the heat shrink tubing over the connector and onto the wire as shown in Figure 7. The shrink tubing must be installed before the housing is on the socket body.
2. Insert the socket housing sub-assembly into the socket contact until it latches with an audible and tactile “click”. The top part of the socket contact features a large flat and latching ledge. Use these features to align to the housing before full assembly. Socket can only be assembled one way into the housing. See Figure 8.

NOTE: 3/0 Contact Shown

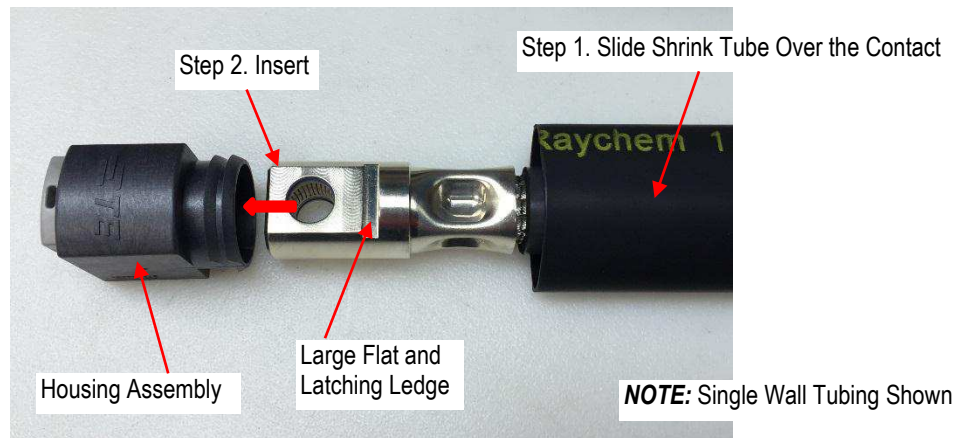

Figure 7

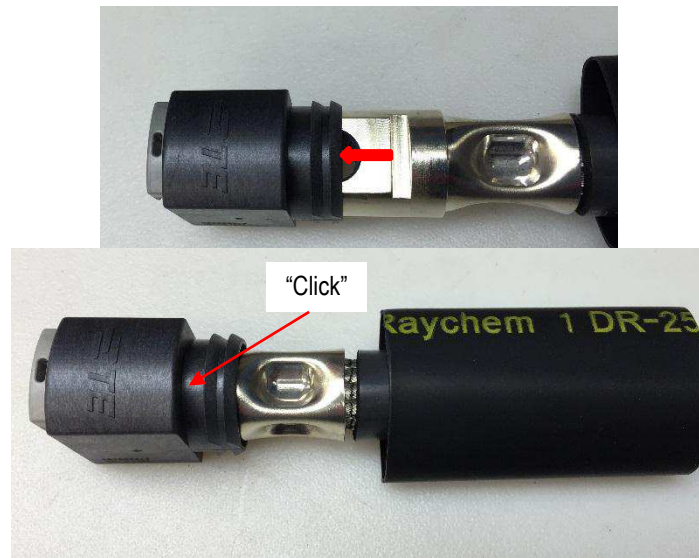

Figure 8

3.6. Heat Shrink Tube Placement and Recover

A. Placement

Slide the heat shrink tubing over the rear of the housing until the tubing is in contact with the housing wall. The housing retaining rings will retain the shrink tubing for sealing and strain relief.

B. Recovery Process

Once the heat shrink tubing is properly located, the recovery process may begin. Refer to Figure 9. The allowable gap between the recovered heat shrink tubing and housing is .100" max. The bottom of the housing should be free of adhesive after the heat shrink tubing recovery operation. Refer to Figure 11.



CAUTION

Avoid over heating the connector housing with the heat gun during shrink tube recovery. Recover heat shrink or boot per the manufacturer's approved installation instructions.

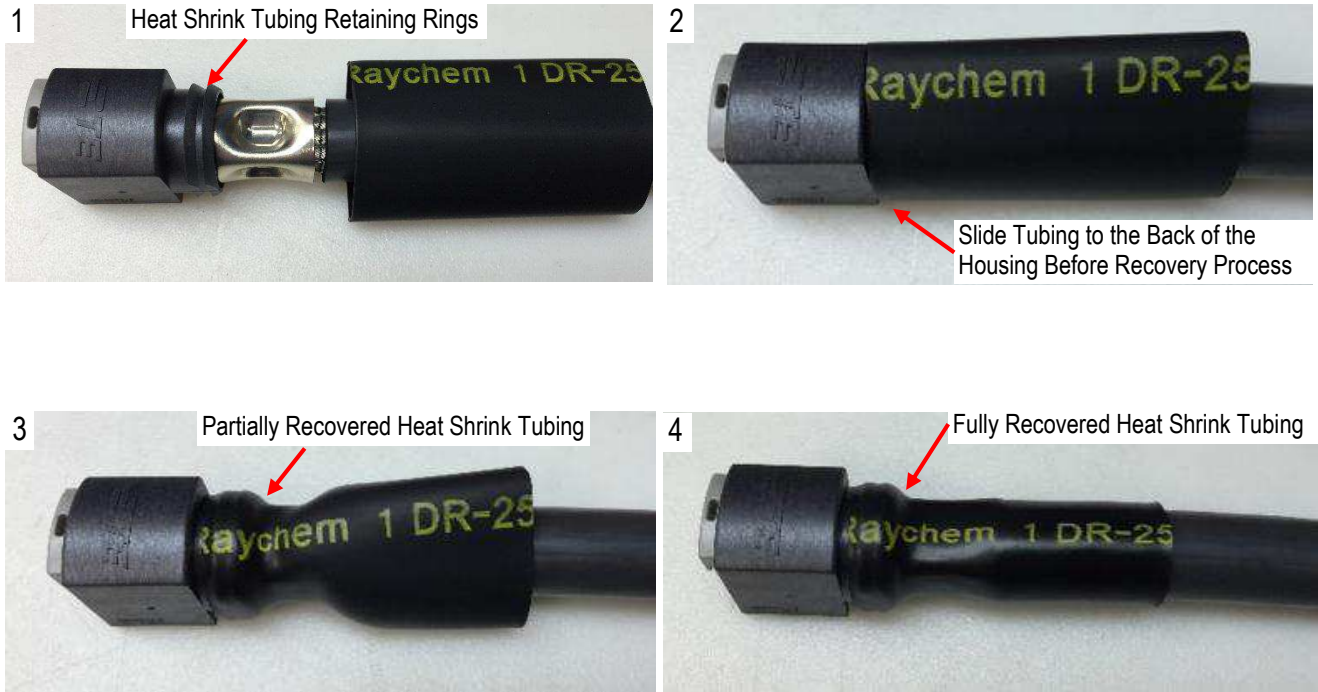

Figure 9



Figure 10

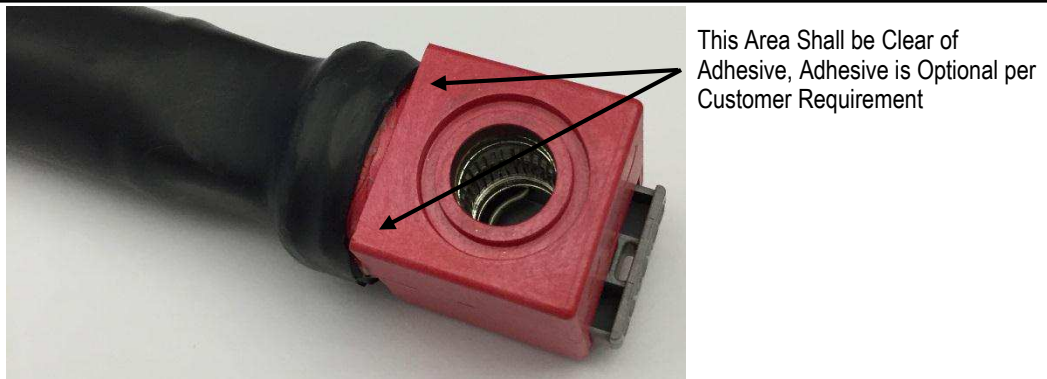

Figure 11

3.7. Post Contact Kit: Installation and Assembly Procedure (Figure 12)

1. Thread the post contact on the bus bar.
2. Torque the threads to [200 in.-lb] nominal (± 20 in.-lb) using 5/8-in. deep socket
3. Install keying ring over the hex-nut area.
4. Push the keying ring firmly over the hex-nut until the audible and tactile “click”.

**NOTE**

The torque requirement specified does not include the use of lubrication on the threads.

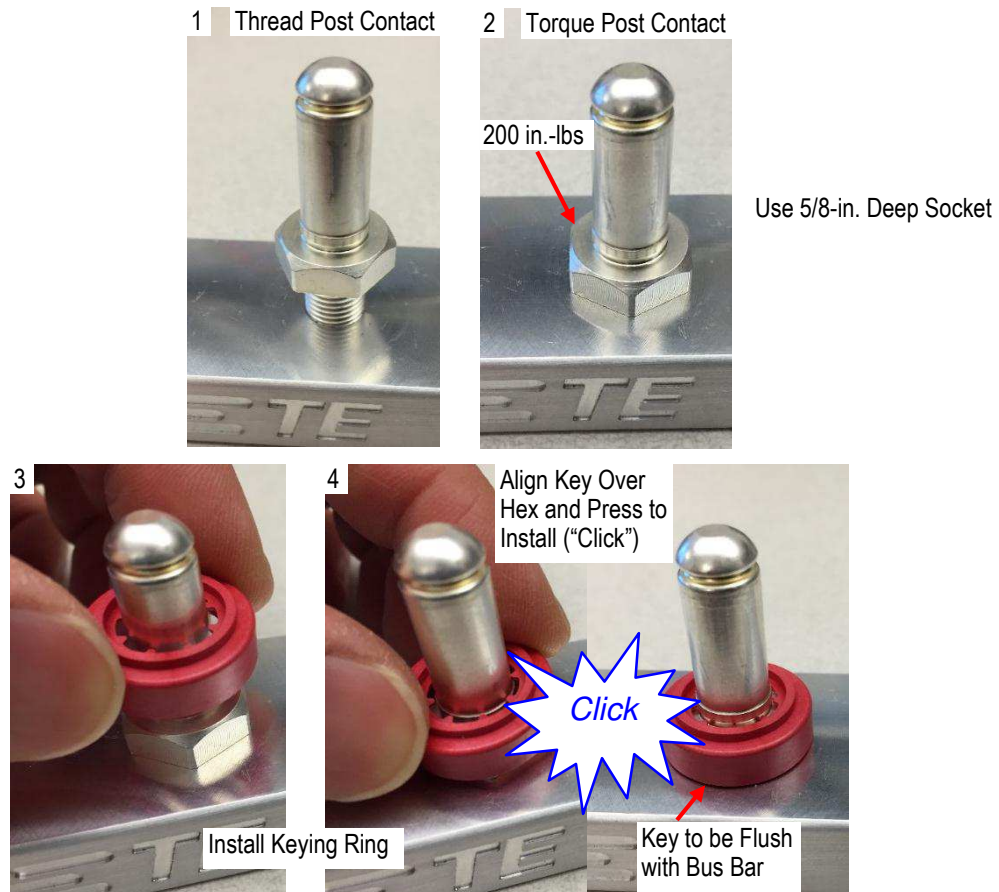

Figure 12

3.8. MATING AND UNMATING

The socket connector cavity must be aligned with the post contact. The socket contact is pushed straight on to the post contact until the socket contact latch mechanism is fully engaged. Do not press the release button when mating the connector. This action will eliminate the audible “click” that indicates a full mate. Connection is complete and locked until the release button is pressed to unmate. See Figure 13.

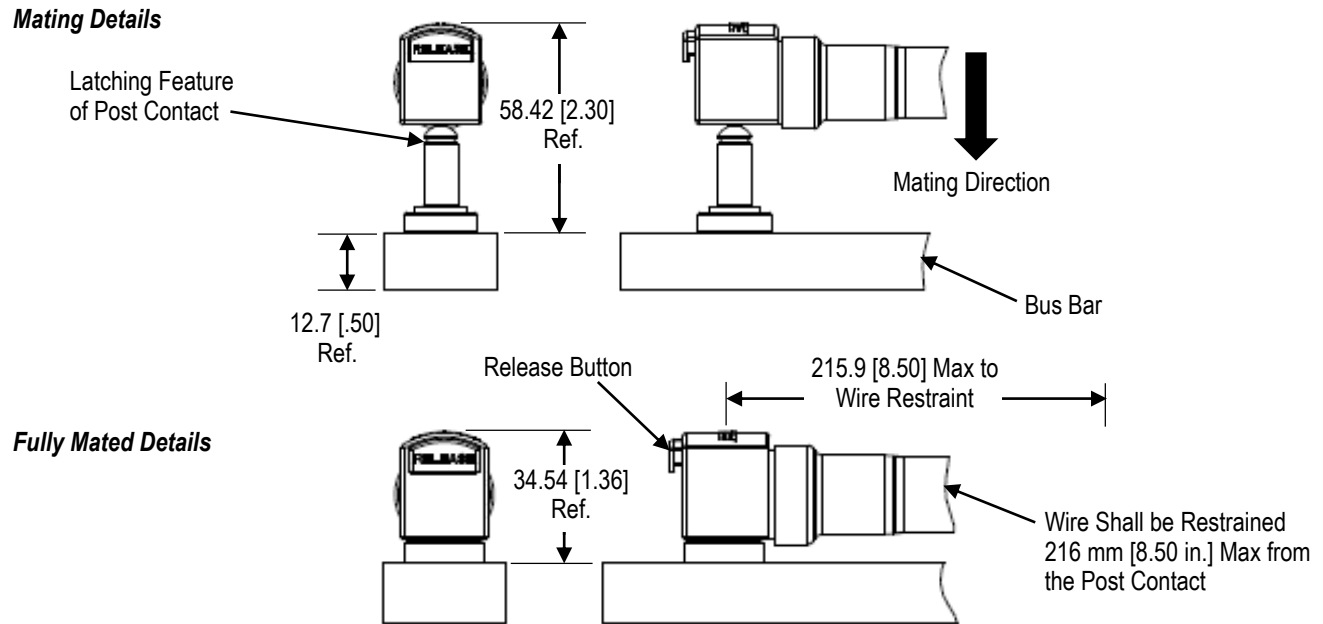

Figure 13

To unmate the socket connector, depress the release button with thumb or finger. While the release button is being depressed, pull the socket connector vertically (opposite of the mating direction) along the post to unmate the connection.

A zip tie can be inserted into the release button to prevent accidental release button activation.

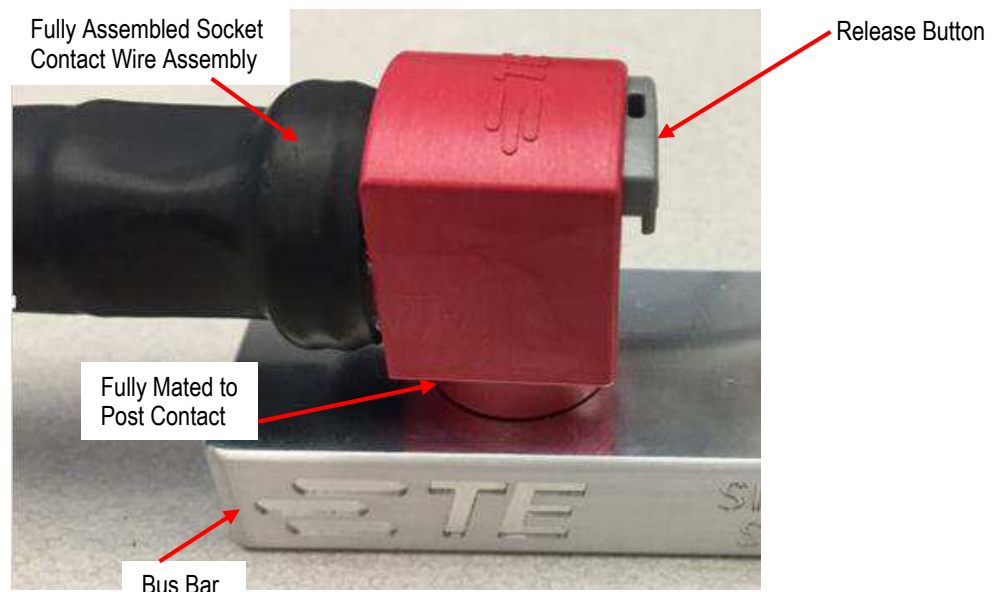

Figure 14

3.9. Repair

The connector assemblies cannot be repaired but can be replaced if damaged and not functioning properly.

The connector socket housing can be replaced if damaged by cutting the shrink tubing off behind the connector housing and pulling off the damaged housing. Remove remaining heat shrink tubing from the wire.

Follow the steps starting with Figure 7 to assemble the new socket housing.

Post contact key may be replaced if damaged by removing the key and replacing it with a new key. A flat screw driver may be used to remove the key if required.

Damaged socket contact or post contact can also be replaced when damaged and not functioning properly.

i **NOTE**
To replace the socket contact, the wire must be cut beyond the crimp barrel to allow a new area to be crimped. This repair will remove approximately one inch from the total wire length.

4. QUALIFICATIONS

Snap-Lug has not been submitted for agency evaluation and testing.

5. TOOLING

Heat gun for application of the heat shrink tubing.

Pico crimp tool 500-DEC. Refer to Figure 2 for crimp tool, crimp die, and locator part numbers. See Figure 15.



Pico Power Unit



Crimp Head



Locator

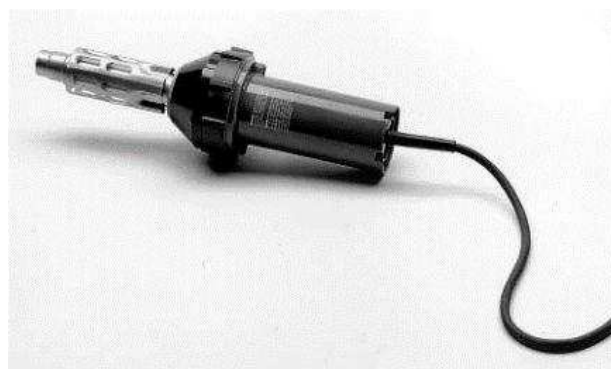

Heat Gun

Figure 15

Pico is a trademark.

6. VISUAL AID

The illustration below shows a typical application of this product. This illustration should be used by production personnel to ensure a correctly applied product. Applications which do not appear correct should be inspected using the information in the preceding pages of this specification and in the instructional material shipped with the product or tooling.

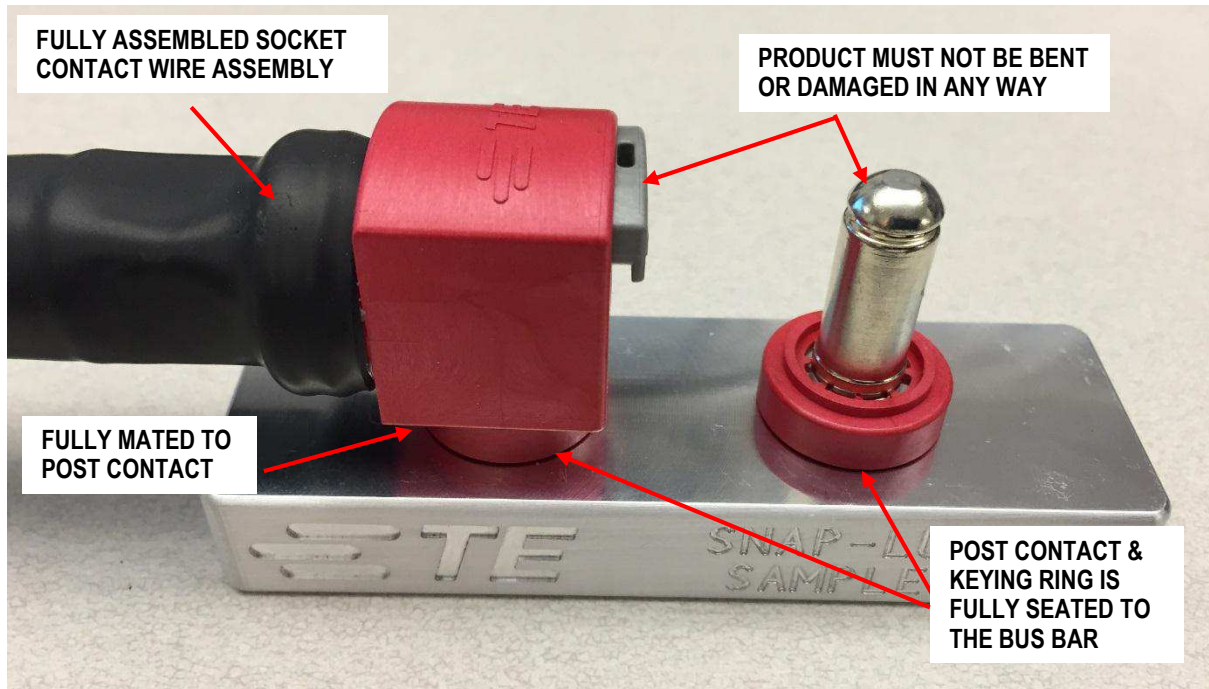

Figure 16 VISUAL AID

X-ON Electronics

Largest Supplier of Electrical and Electronic Components

Click to view similar products for [Heavy Duty Power Connectors](#) category:

Click to view products by [TE Connectivity](#) manufacturer:

Other Similar products are found below :

[647757-1](#) [6643411-1](#) [6646058-2](#) [6646137-1](#) [6646138-1](#) [6646479-1](#) [6646608-1](#) [6646786-1](#) [6646940-1](#) [6651091-1](#) [6651525-1](#) [6651529-1](#)
[6651788-1](#) [696475-1](#) [702-32-01109](#) [703-25-02205](#) [73000005059](#) [73000005642](#) [73080255059](#) [73080965046](#) [765-15-0080A](#) [765-16-0080B](#)
[765-18-0080D](#) [829992-1](#) [902-77-02113](#) [PS00/A0620/6300](#) [PS25/A0420/63](#) [129-1J](#) [1409400](#) [AN0024023](#) [E6374G1](#) [e6389g2](#) [157-43GW8](#)
[MS3117-14AC](#) [1643543-1](#) [1650540-1](#) [1651811-2](#) [1766260-1](#) [1766282-1](#) [1766966-1](#) [1791340000](#) [NLDFT-3-BL-L-S120-M40A](#) [NLDFT-N-](#)
[W-L-C240-M40B](#) [NLS-2-R-C240-M40B](#) [NLS-N-W-C240-M40B](#) [NPS-3-BL-T6](#) [1986615-1](#) [2-1589900-8](#) [2199314-1](#) [KA8102](#)