

LOC		DIST		REVISIONS			
REV	BY	DATE	DESCRIPTION	DATE	OWN	APVD	
V		7-31-13	REV PER ECO 13-010224		CT	WM	

- ① 00779 M39012/26B0016 AMP 225550-1 YY WW
- ② 00779 M39012/26B0007 AMP 225550-3 YY WW
- 3. USE INSTRUCTION SHEET 2299-1
- ④ SEE SEPERATE RESTRICTED DRAWING FOR THIS PART NUMBER

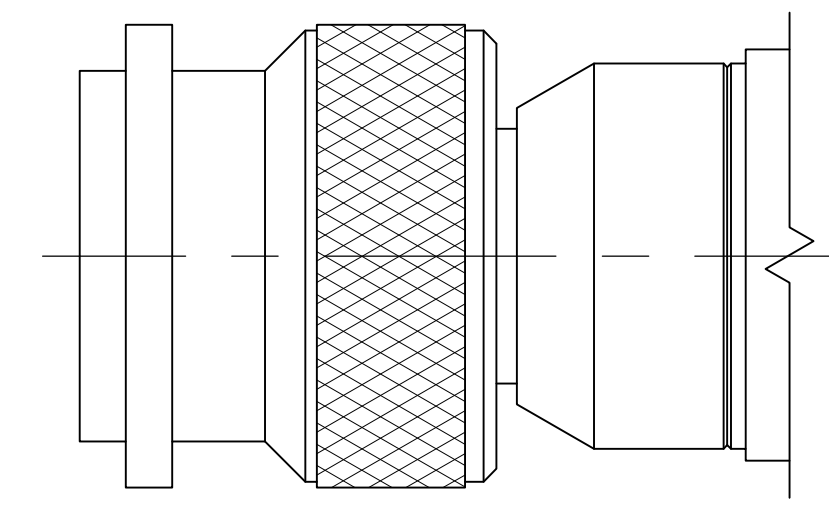

VIEW Y
SAME AS VIEW X
EXCEPT AS SHOWN

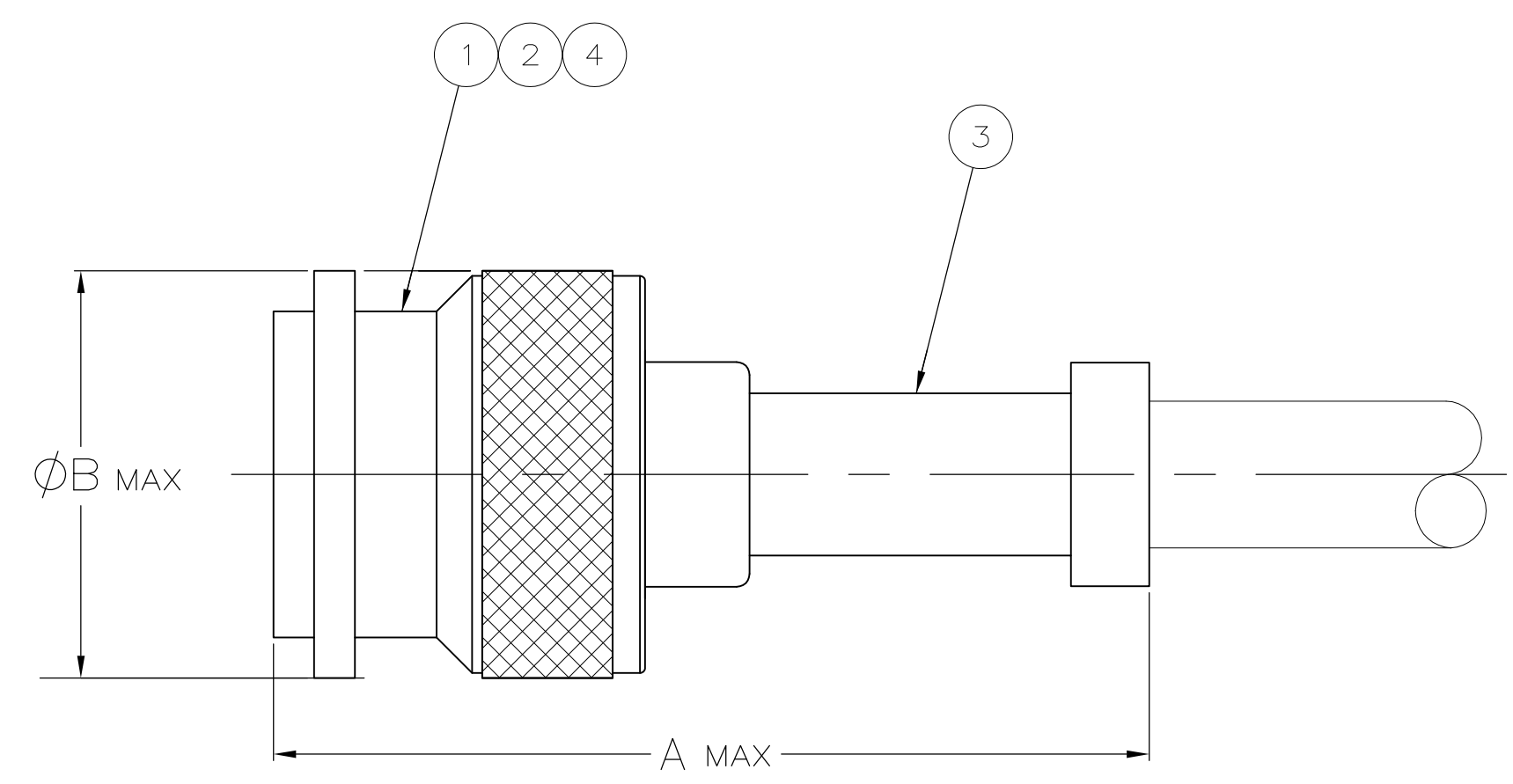
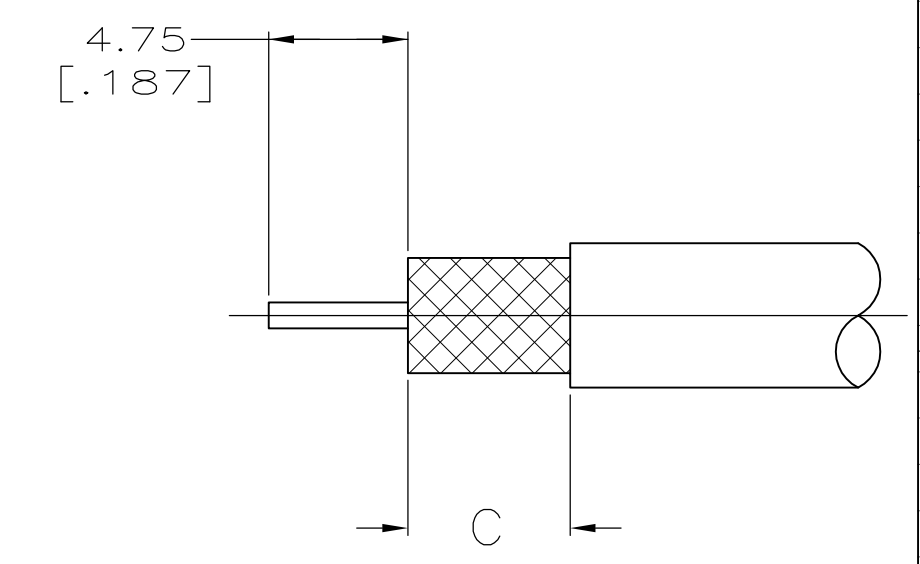
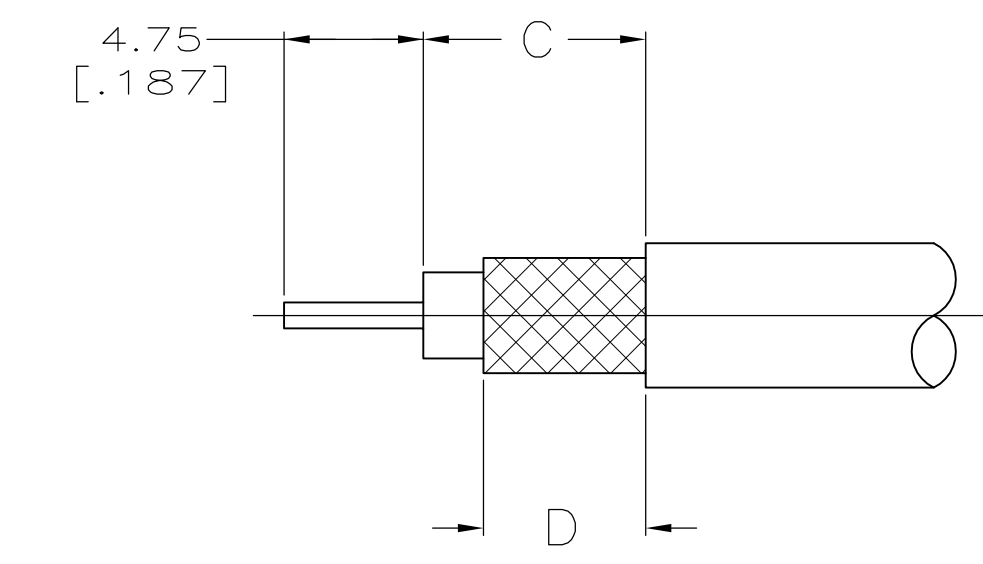

FIG 1

FIG 2

RECOMMENDED STRIP LENGTH

	④																	
	OBSOLETE	TIMES AA-5886	2	7-225550-7 AMP	220015-1	-	12.70 [.500]	16.00 [.630]	51.05 [2.010]	332022	1-331987-0	225526-6	225593-2	X	7-225550-8			
SUPERSEDED BY	225550-6	RG-142/U,142A/U & 142B/U	1	7-225550-6 AMP	220045-2	8.71 [.343]	10.31 [.406]	16.26 [.640]	34.93 [1.375]	225592-2	225560-1	225467-6	1663000-1	X	7-225550-6			
	OBSOLETE	TIMES AA-5887	2	7-225550-5 AMP	220015-1	-	12.70 [.500]	16.00 [.630]	51.97 [2.046]	-	225612-2	225596-4	5-225593-2	X	7-225550-5			
	OBSOLETE	RG-59B/U,62B/U & BSX 7002-59/U	1	7-225550-3 AMP	220045-3	5.56 [.219]	7.14 [.281]	16.26 [.640]	34.93 [1.375]	225592-3	225560-3	225467-4	1663000-3	X	7-225550-3			
SUPERSEDED BY	225550-2	RG-58A/U & 58C/U	1	7-225550-2 AMP	220045-2	8.71 [.343]	10.31 [.406]	16.26 [.640]	34.93 [1.375]	225592-1	225560-2	225467-2	1663000-1	X	7-225550-2			
	OBSOLETE	RG-180/U,180A/U & 180B/U	1	1-225550-9 AMP	220045-2	8.71 [.343]	10.31 [.406]	16.26 [.640]	34.93 [1.375]	225592-1	1-225560-4	1-225467-0	1663000-1	X	1-225550-9			
	OBSOLETE	MICRODOT 250-4172 & 250-4208	1	1-225550-8 AMP	220015-3	9.53 [.375]	12.70 [.500]	16.26 [.640]	51.59 [2.031]	225908-1	9-225612-0	225596-2	225593-3	X	1-225550-8			
	OBSOLETE	MICRODOT 250-4171 & 250-4207	1	1-225550-7 AMP	220015-3	9.53 [.375]	12.70 [.500]	16.26 [.640]	51.97 [2.046]	225908-1	225612-1	225596-2	225593-3	X	1-225550-7			
		RG-393/U	2	1-225550-3 AMP	220015-1	-	12.70 [.500]	16.26 [.640]	50.67 [1.995]	332022	9-225490-1	225526-2	225593-2	Y	1-225550-3			
		RG-225/U	2	1-225550-2 AMP	220015-1	-	12.70 [.500]	16.26 [.640]	50.80 [2.000]	332022	9-331987-3	225526-2	225593-2	Y	1-225550-2			
		RG-9/U,9A/U,9B/U & 214/U	2	225550-8 AMP	220015-1	-	12.70 [.500]	16.26 [.640]	50.80 [2.000]	332022	9-331987-3	225596-2	225593-2	X	225550-8			
SUPERSEDED BY	225550-7	RG-8/U,8A/U & 213/U	1	225550-7 AMP	220015-1	9.53 [.375]	12.70 [.500]	16.26 [.640]	50.80 [2.000]	332022	1-331987-3	225596-2	225593-2	Y	225550-7			
		RG-142/U,142A/U,142B/U & 400/U	1	00779 M39012/26B0006 AMP YY WW	220045-2	8.71 [.343]	10.31 [.406]	16.26 [.640]	34.93 [1.375]	225592-2	9-225560-4	1-225467-3	1663000-1	X	225550-6			
	OBSOLETE	RG-59B/U,62B/U & BSX 7002-59/U	1	2	220045-3	5.56 [.219]	7.14 [.281]	16.26 [.640]	34.93 [1.375]	225592-3	225560-3	1-225467-2	1663000-3	X	225550-3			
		RG-58A/U & 58C/U	1	00779 M39012/26B0005 AMP YY WW	220045-2	8.71 [.343]	10.31 [.406]	16.26 [.640]	34.93 [1.375]	225592-1	9-225560-5	1-225467-1	1663000-1	X	225550-2			
		RG-55A/U & 223/U	1	1	220045-2	8.71 [.343]	10.31 [.406]	16.26 [.640]	34.93 [1.375]	225592-2	9-225560-4	1-225467-1	1663000-1	X	225550-1			
		CABLE SIZE	FIG	STAMPING	CRIMP TOOL	D	C	B	A	④ GASKET QTY=1	③ FERRULE QTY=1	② CONTACT QTY=1	① PLUG ASSY QTY=1	VIEW	PART NUMBER			

THIS DRAWING IS A CONTROLLED DOCUMENT.

STE TE Connectivity

PLUG, WEATHERPROOF, SERIES TNC

108-12001

00779 225550

SCALE 4:1 SHEET 1 OF 1 REV V

X-ON Electronics

Largest Supplier of Electrical and Electronic Components

Click to view similar products for [RF Connectors / Coaxial Connectors](#) category:

Click to view products by [TE Connectivity](#) manufacturer:

Other Similar products are found below :

[8915-1511-000](#) [89674-0827](#) [6001-7071-019](#) [6002-7051-003](#) [6002-7551-202](#) [6059674-1](#) [619550-1](#) [630059-000](#) [M39030/3-01N](#) [6500-7071-046](#) [6769](#) [CX050L2AQ](#) [7002-1541-010](#) [7002-1542-011](#) [7004-1512-000](#) [7009-1511-004](#) [7010-1511-000](#) [7029-1511-060](#) [7101-1541-010](#) [7101-1571-002](#) [7105-1521-002](#) [7145-1521-002](#) [7203-1571-003](#) [7209-1511-011](#) [7210-1511-015](#) [7210-1511-019](#) [73137-5015](#) [73216-2241](#) [73404-2300](#) [7405-1521-005](#) [7405-1521-802](#) [8527](#) [8547](#) [FS11V](#) [877931](#) [9049-9513-000](#) [9074-9513-000](#) [9101-9573-002](#) [910A205F](#) [9130-9573-002](#) [PL11SC-026](#) [PL375-33](#) [PL40-5](#) [PL74C-221](#) [PL75MC-217](#) [PL803-7](#) [1200690078](#) [1-201144-1](#) [R107003010W](#) [R110A172100](#)