

THIS DRAWING IS UNPUBLISHED. RELEASED FOR PUBLICATION  
 © COPYRIGHT - Tyco Electronics JAPAN G.K. ALL RIGHTS RESERVED.

LOC	DIST	REVISIONS					
		P	LTR	DESCRIPTION	DATE	DWN	APVD
ES	-	C		ECR-17-006884	28NOV2016	B.L	C.W

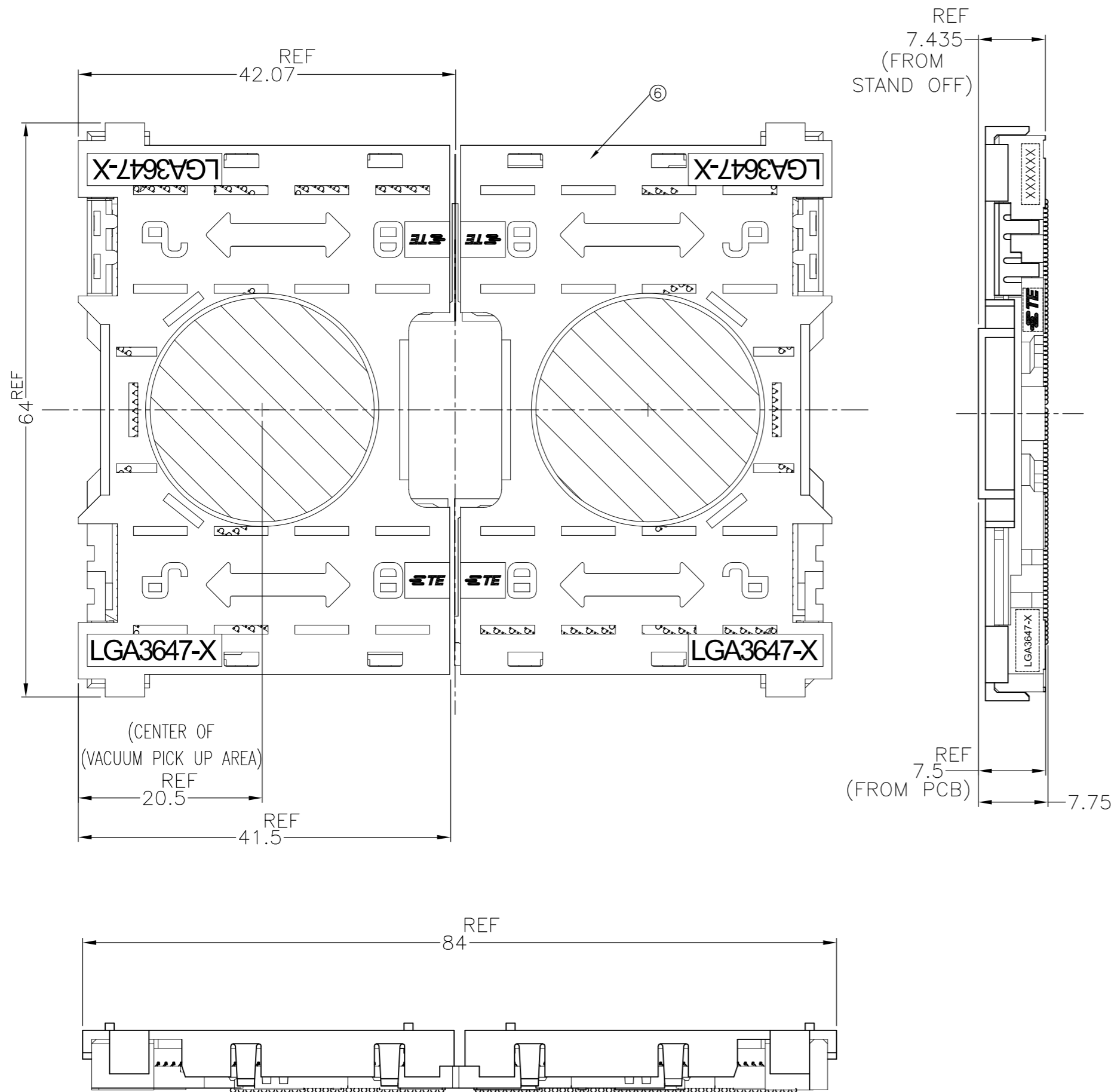

AFTER SMT CONDITION (WITH CAP)

1. MATERIAL
- ① HOUSING : HIGH TEMP, THERMO-PLASTIC, UL94V-0, BLACK
  - ② CONTACT : COPPER ALLOY  
FINISH : Au PL. SHOW AS  $\Delta$  AT CONTACT AREA  
ON OVERALL OVER Ni UNDER PL. 0.00127 MIN.
  - ③ SOLDER BALL : Sn/Ag/Cu
  - ④ KEY HSG LEFT : HIGH TEMP. THERMO-PLASTIC, UL94V-0, BLACK
  - ⑤ KEY HSG RIGHT: HIGH TEMP. THERMO-PLASTIC, UL94V-0, P0 YELLOW, P1 NATURAL
  - ⑥ CAP : HIGH TEMP. THERMO-PLASTIC, UL94V-0, NATURAL
- $\Delta$  INDICATED DATE CODE , TYCO LOGO, PRODUCT NAME ON THE HSG  
 $\Delta$  FOR NORMAL ORDER, LEFT AND RIGHT SEGMENT SHOULD ORDER AT SAME TIME

$\Delta$ 30U AU PLATING		$\Delta$ 15U AU PLATING		PLATING SPEC.
LGA3647-1 SOCKET P1	LGA3647-0 SOCKET P0	LGA3647-1 SOCKET P1	LGA3647-0 SOCKET P0	
LGA3647-1 RIGHT SEGMENT	LGA3647-1 LEFT SEGMENT	LGA3647-0 RIGHT SEGMENT	LGA3647-0 LEFT SEGMENT	PRODUCT NAME
2822980-4	1-2822980-4	2822980-3	1-2822980-3	ASSY PART NUMBER

14.5	21	17	1	1	1	1	1	1	1	2-2822979-4
		16			1					2-2822979-3
	21	17				1				2-2822979-2
		16					1		1	2-2822979-1
PRODUCT WEIGHT (g/SOCKET)	DIMENSION D2	DIMENSION D1	QTY.						ORDER PART NO.	

THIS DRAWING IS A CONTROLLED DOCUMENT.

DWN T.KUO 04MAR2015		TE Connectivity			
CHK M.CHAO 04MAR2015		NAME			
APVD M.CHAO 04MAR2015		SOCKET ASSY			
PRODUCT SPEC		LGA3647-X			
APPLICATION SPEC	108-115115	SIZE	CAGE CODE	DRAWING NO	RESTRICTED TO
114-115011	A2	00779	C=2822979		
WEIGHT	CUSTOMER DRAWING		SCALE	SHEET	REV
-			NTS	1 OF 7	C

THIS DRAWING IS UNPUBLISHED. RELEASED FOR PUBLICATION  
 © COPYRIGHT - Tyco Electronics JAPAN G.K. ALL RIGHTS RESERVED.

LOC	DIST	REVISIONS					
		P	LTR	DESCRIPTION	DATE	DWN	APVD
ES	-	-	-	SEE SHEET 1	-	-	-

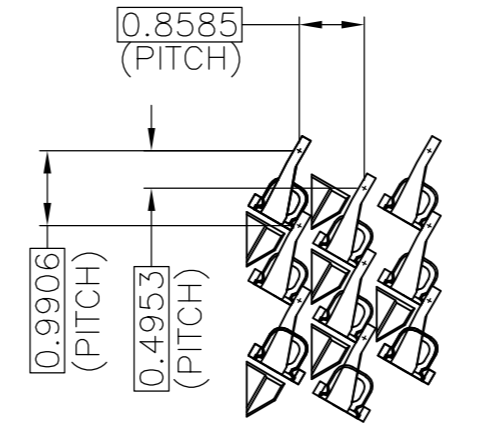
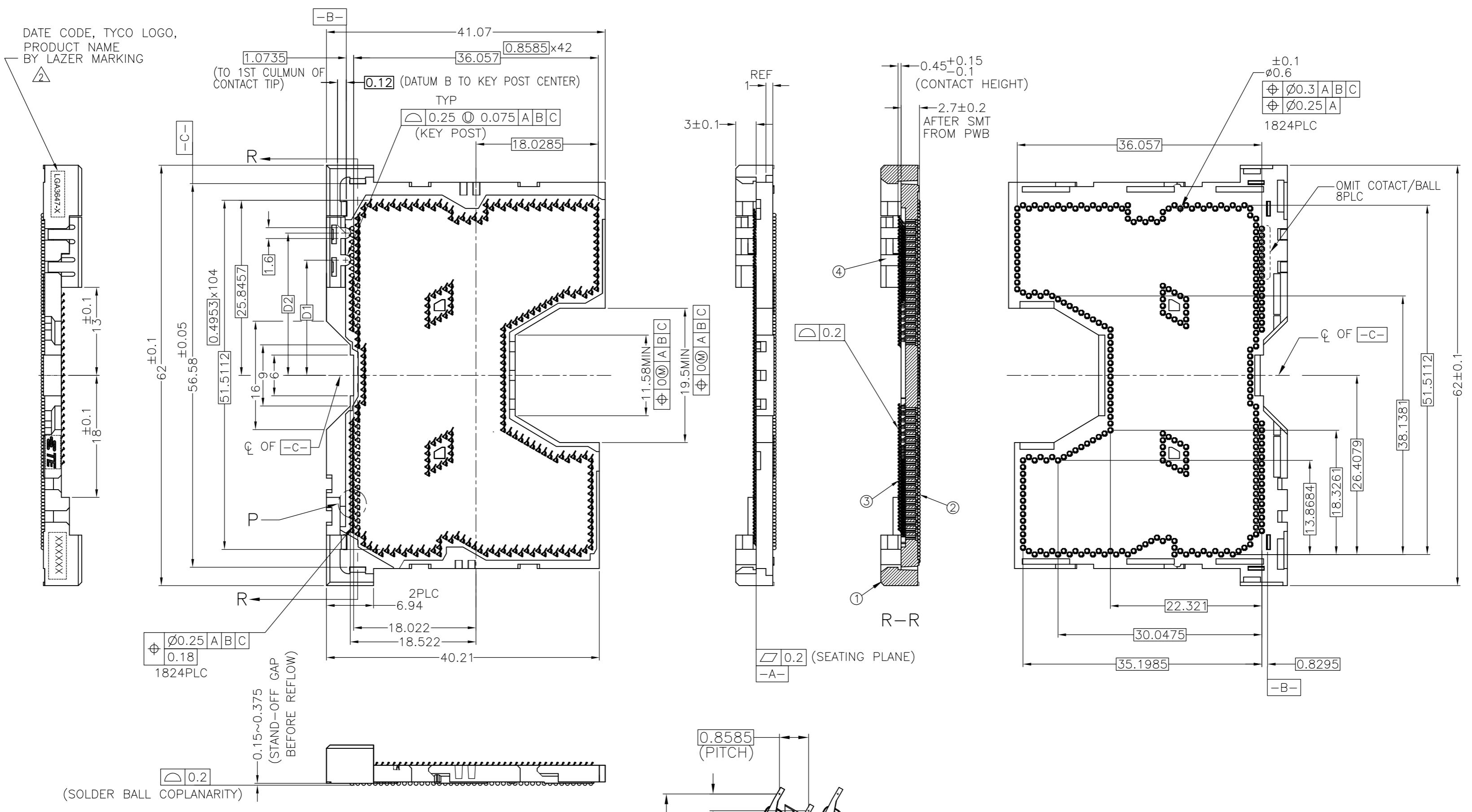

DETAIL P(10:1)

THESE VIEW DON'T SHOW CAP BEFORE SMT CONDITION  
 LGA3647-1 LEFT SIDE ASSY  
 1-2822980-\* AS SHOWN

THIS DRAWING IS A CONTROLLED DOCUMENT.		DWN -	TE Connectivity			
DIMENSIONS: mm		CHK -			NAME	
TOLERANCES UNLESS OTHERWISE SPECIFIED:		APVD -	SOCKET ASSY LGA3647-X			
0-PLC ± 1-PLC ±0.3 2-PLC ± 3-PLC ±3 4-PLC ± ANGLES ± FINISH -		PRODUCT SPEC -	SIZE A2	CAGE CODE 00779	DRAWING NO C=2822979	RESTRICTED TO -
MATERIAL -		APPLICATION SPEC -	WEIGHT -	SCALE NTS		SHEET 2 OF 7
		CUSTOMER DRAWING	REV C			

THIS DRAWING IS UNPUBLISHED. RELEASED FOR PUBLICATION  
 © COPYRIGHT - Tyco Electronics JAPAN G.K. ALL RIGHTS RESERVED.

LOC		DIST		REVISIONS			
P	LTR	DESCRIPTION	DATE	DWN	APVD		
ES	-	SEE SHEET 1	-	-	-		

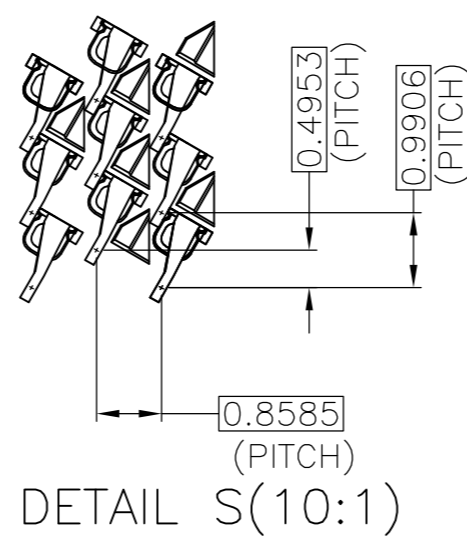
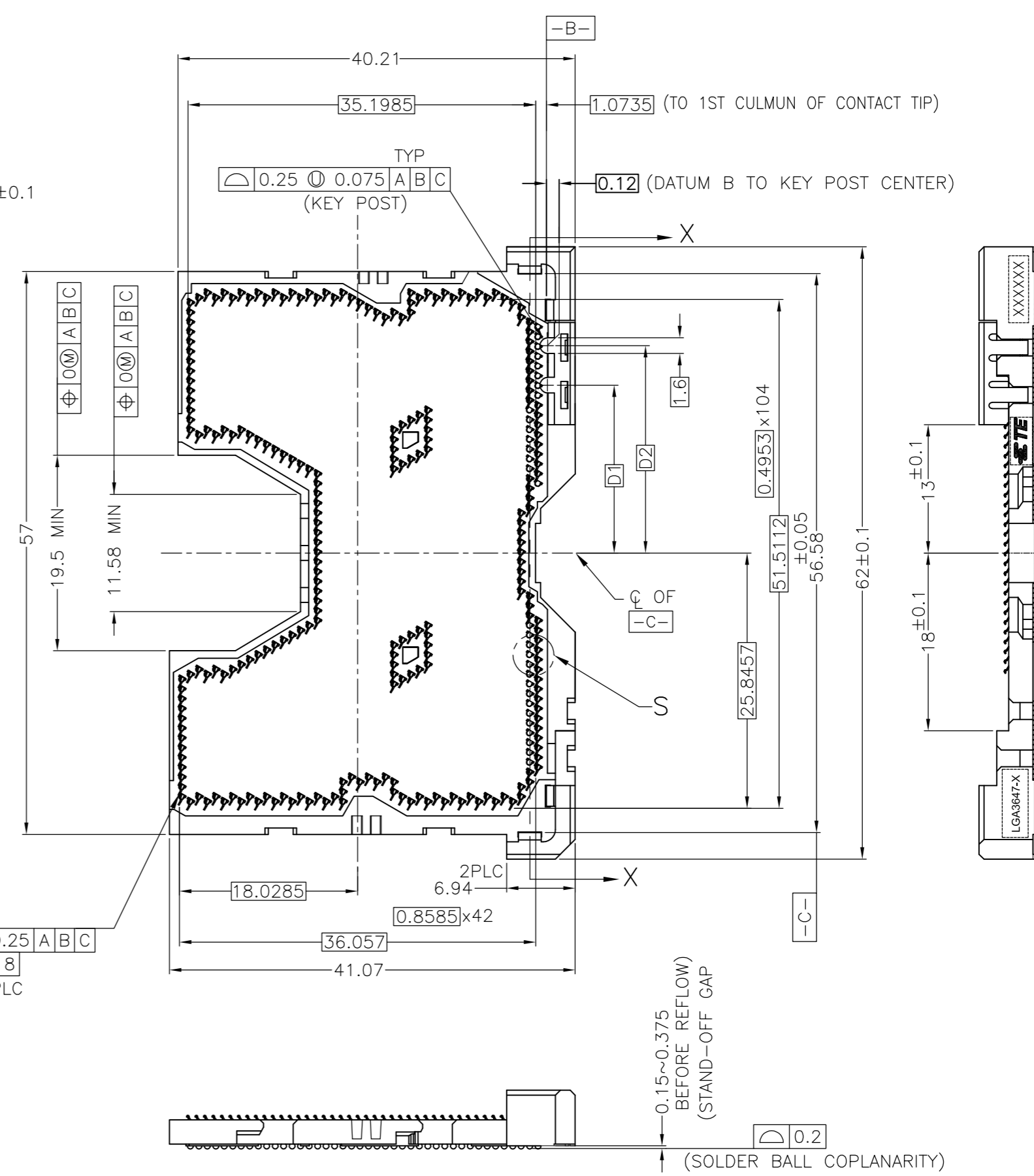
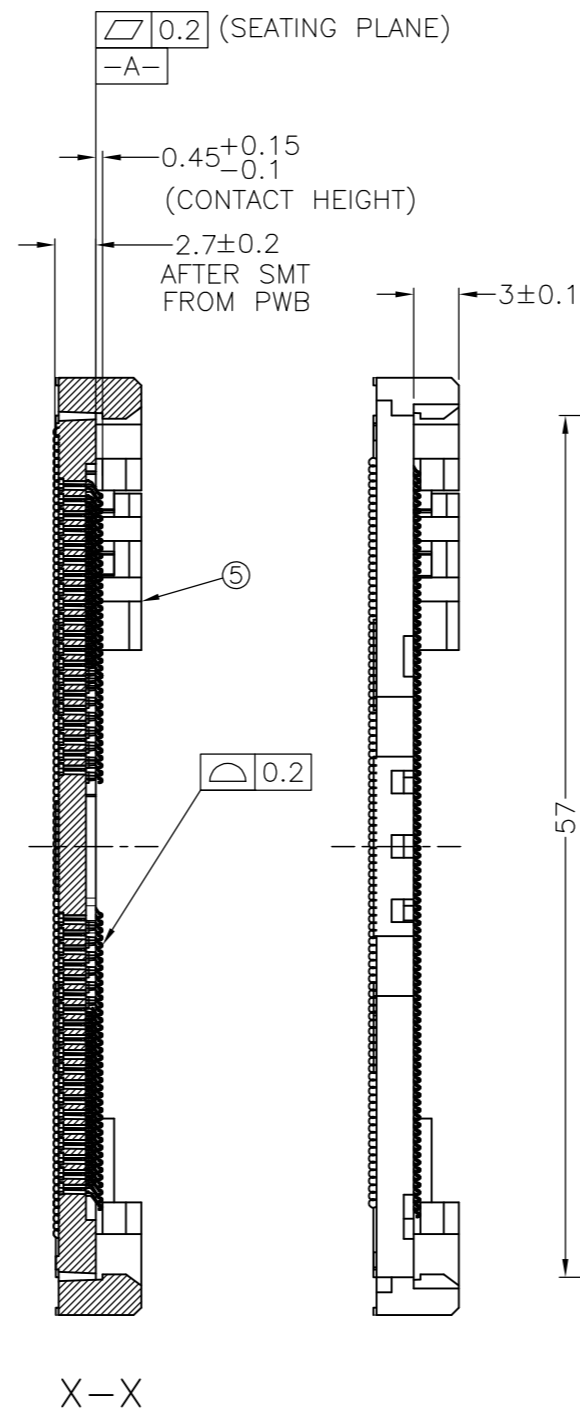
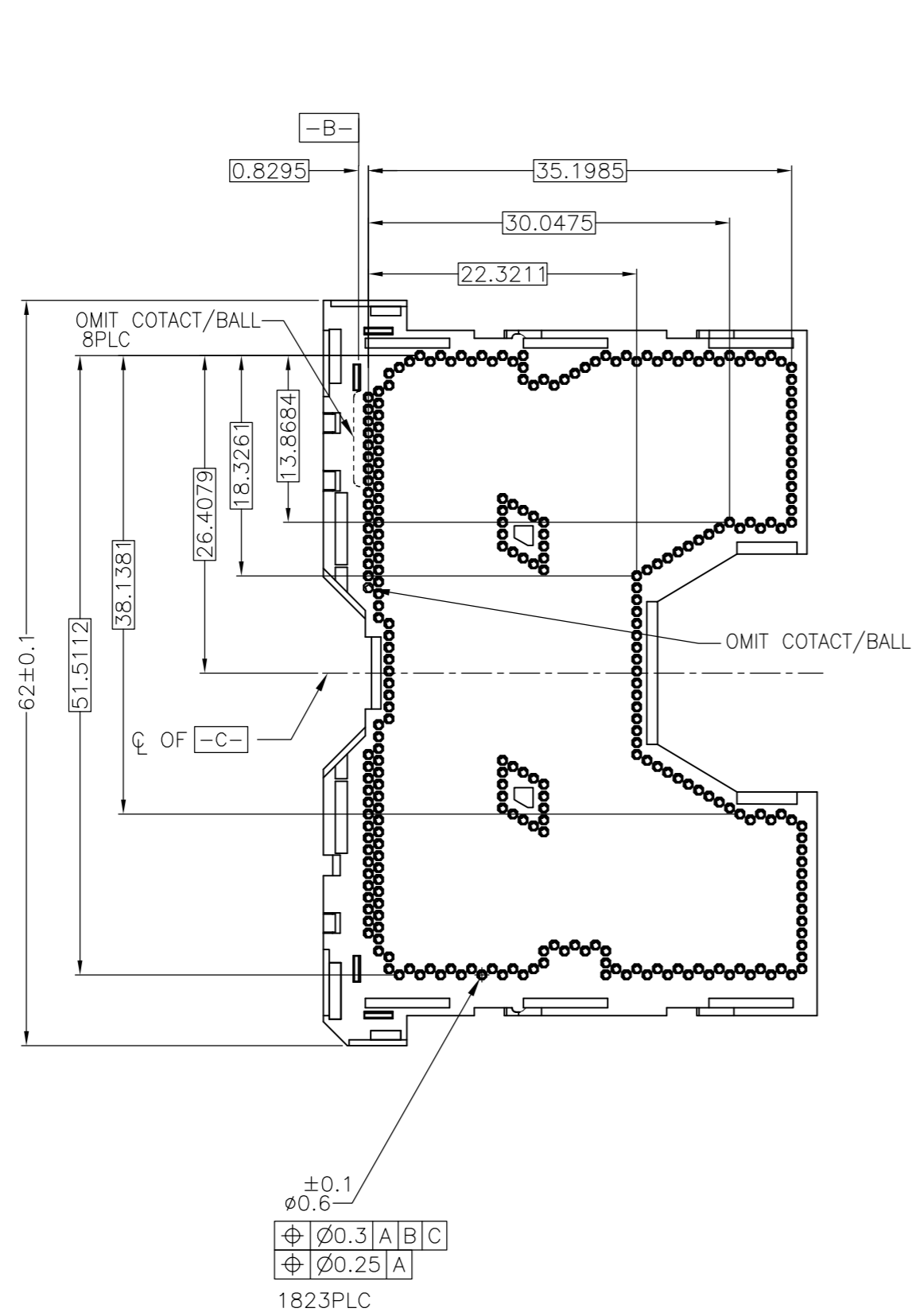

THESE VIEW DON'T SHOW CAP BEFORE SMT CONDITION LGA3647-1 RIGHT SIDE ASSY 2822980-\* AS SHOWN

THIS DRAWING IS A CONTROLLED DOCUMENT.		DWN	TE Connectivity	
DIMENSIONS: mm		CHK	NAME	
TOLERANCES UNLESS OTHERWISE SPECIFIED:		APVD	SOCKET ASSY LGA3647-X	
0-PLC ±		PRODUCT SPEC	SIZE	CAGE CODE
1-PLC ± ±0.3		APPLICATION SPEC	A2	00779
2-PLC ± ±3		WEIGHT	DRAWING NO	RESTRICTED TO
3-PLC ±		CUSTOMER DRAWING	C=2822979	-
4-PLC ±		SCALE	NTS	SHEET
ANGLES ±		SCALE	NTS	3 OF 7
FINISH		SCALE	NTS	REV
		SCALE	NTS	C



THIS DRAWING IS UNPUBLISHED. RELEASED FOR PUBLICATION  
 © COPYRIGHT - Tyco Electronics JAPAN G.K. ALL RIGHTS RESERVED.

LOC		DIST		REVISIONS			
P	LTR	DESCRIPTION	DATE	DWN	APVD		
-	-	SEE SHEET 1	-	-	-		

D

C

B

A

D

C

B

A

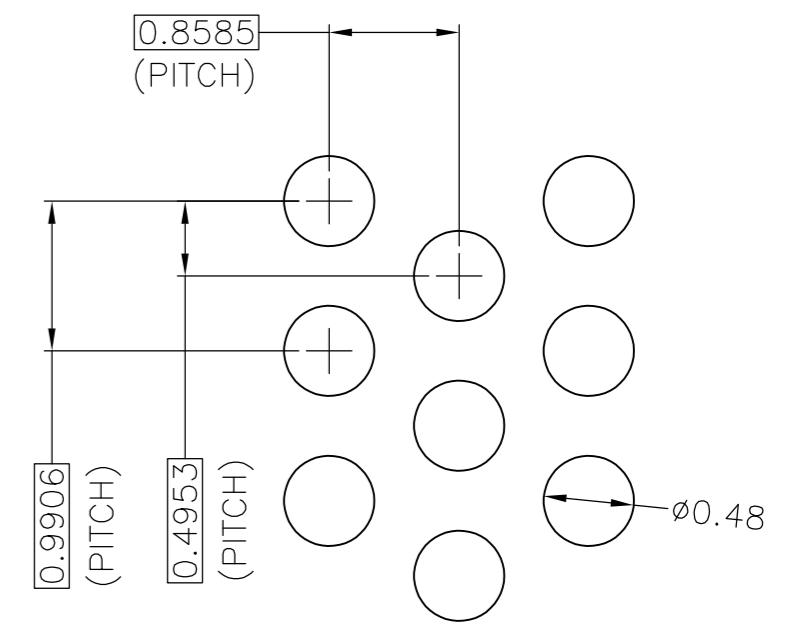
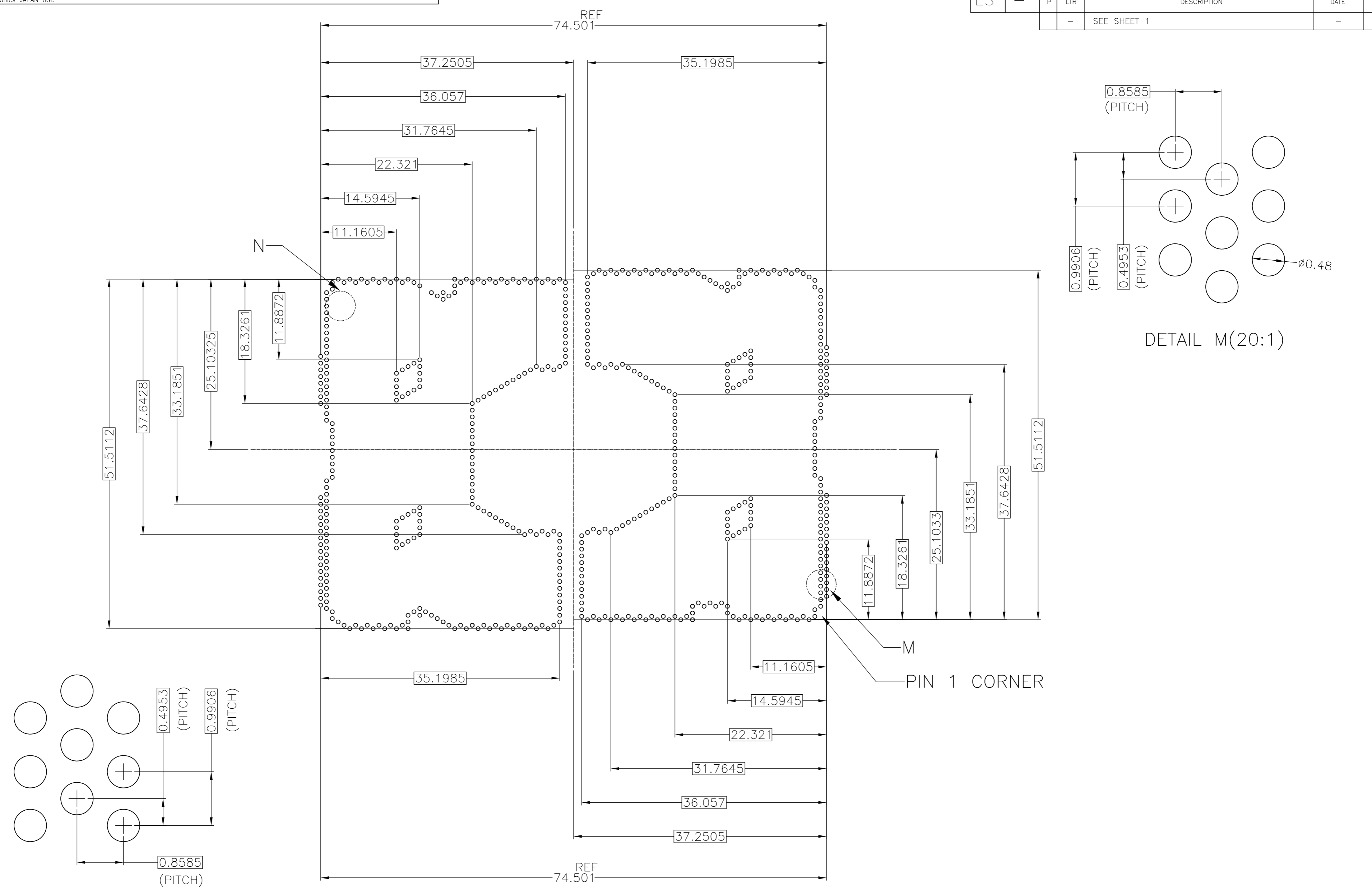

DETAIL M(20:1)

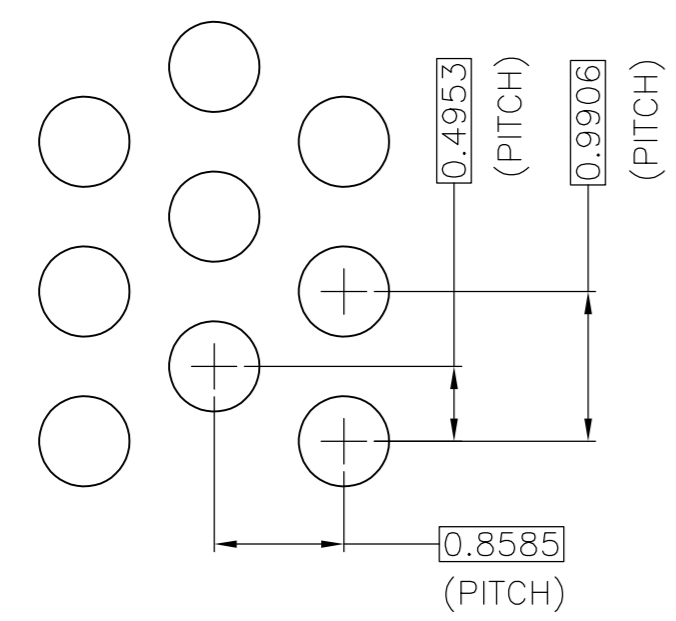

DETAIL N(20:1)

2822979

THIS DRAWING IS A CONTROLLED DOCUMENT.		DWN	-		 TE Connectivity	NAME		SOCKET ASSY		
DIMENSIONS: mm		CHK	-			APPLICATION SPEC		LGA3647-X		
TOLERANCES UNLESS OTHERWISE SPECIFIED:		APVD	-			SIZE	CAGE CODE	DRAWING NO	RESTRICTED TO	
0-PLC ±		PRODUCT SPEC		A2		00779	C=2822979	-		
1-PLC ± ±0.3		APPLICATION SPEC		WEIGHT		SCALE		SHEET	REV	
2-PLC ± ±3		MATERIAL		CUSTOMER DRAWING		NTS		5 of 7	C	
3-PLC ±		FINISH								
4-PLC ±										
ANGLES ±										

THIS DRAWING IS UNPUBLISHED. RELEASED FOR PUBLICATION  
 © COPYRIGHT - Tyco Electronics JAPAN G.K. ALL RIGHTS RESERVED.

LOC	DIST	REVISIONS					
		P	LTR	DESCRIPTION	DATE	DWN	APVD
ES	-	-	-	SEE SHEET 1	-	-	-

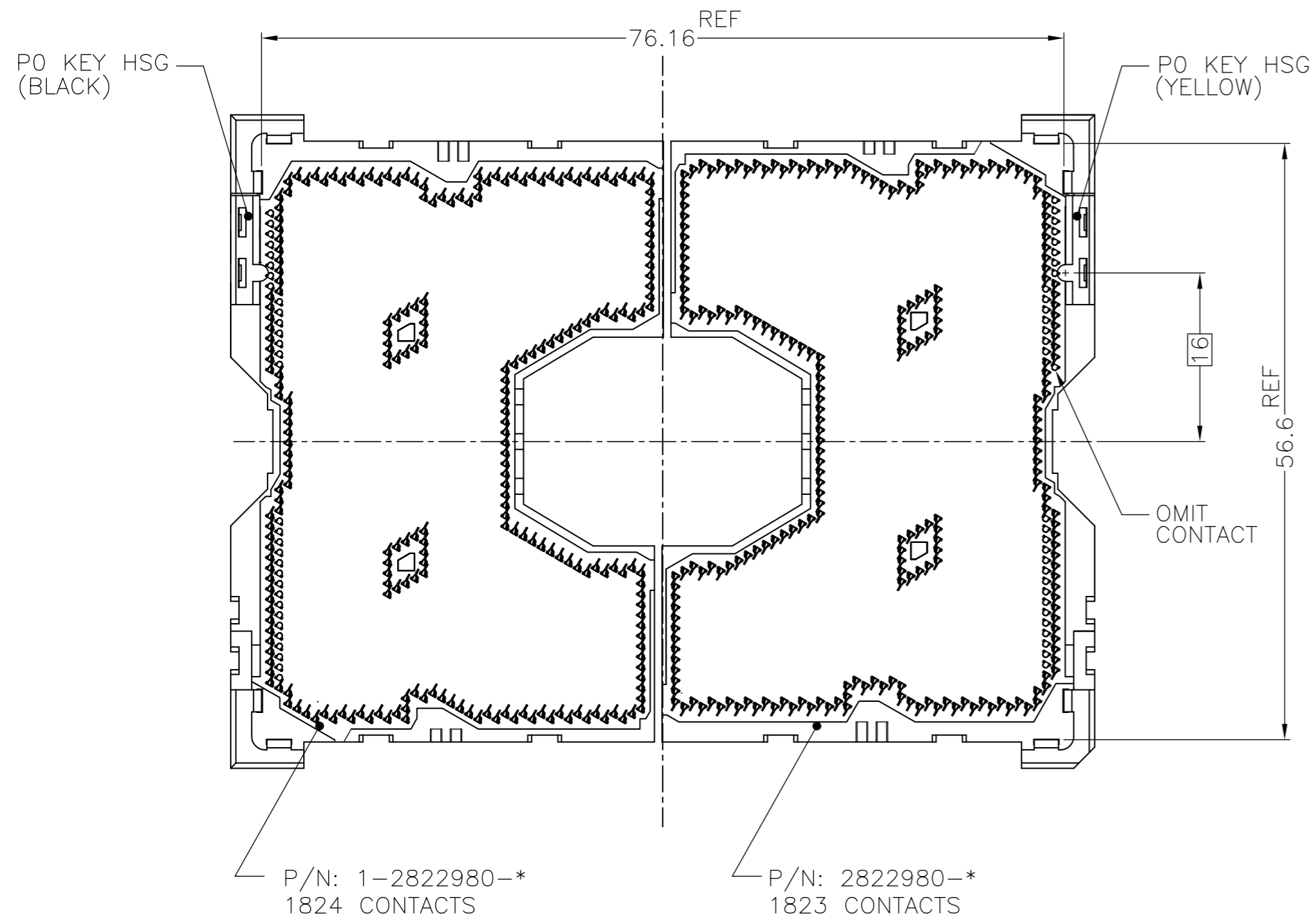

LGA3647-0 AS SHOWN  
(KIT P/N: 2-2822979-\*)

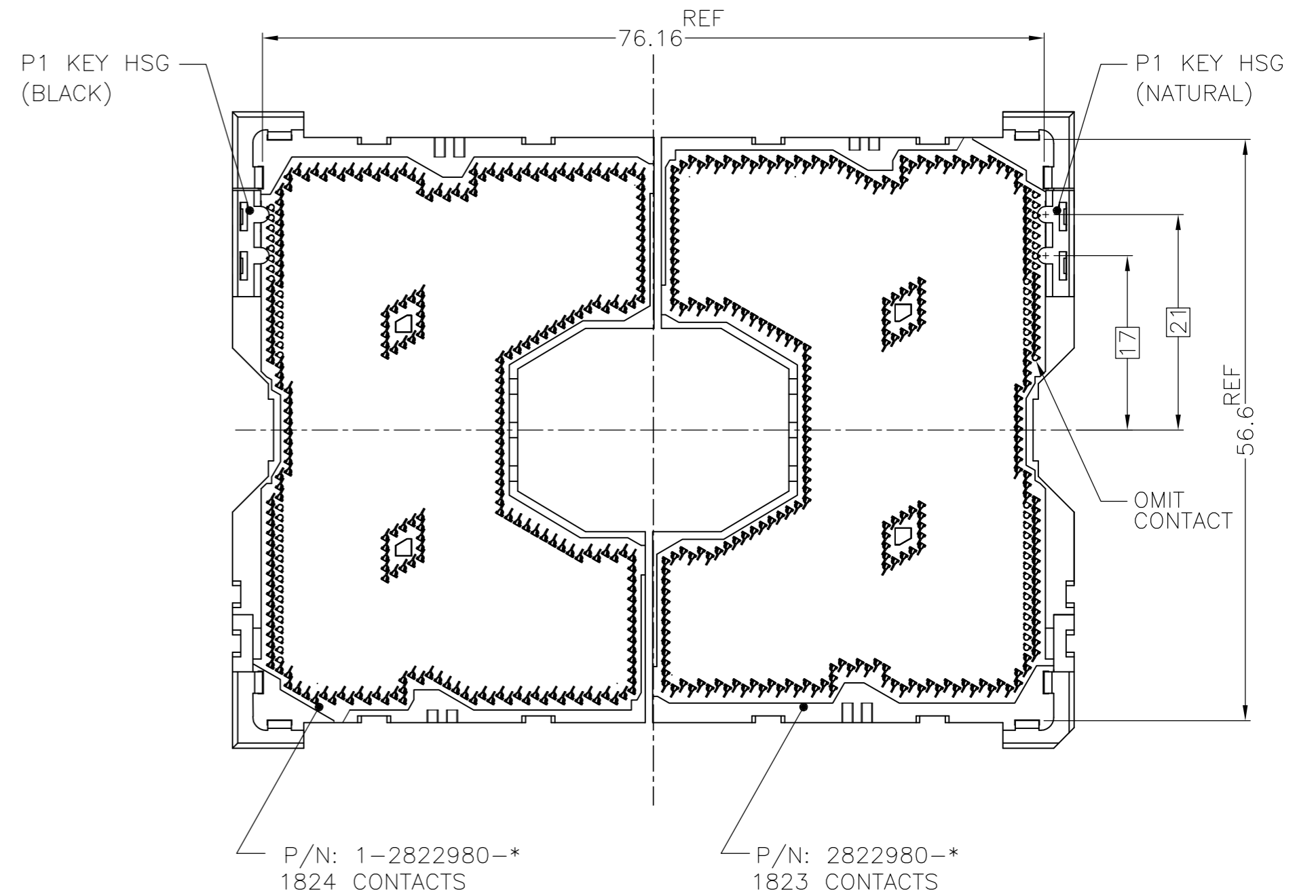

LGA3647-1 AS SHOWN  
(KIT P/N: 2-2822979-\*)

LGA3647-X POST SMT CONDITION  
(PCB IS NOT SHOWN)

THIS DRAWING IS A CONTROLLED DOCUMENT.		DWN	TE Connectivity		
DIMENSIONS: mm		CHK	NAME		
TOLERANCES UNLESS OTHERWISE SPECIFIED:		APVD	SOCKET ASSY LGA3647-X		
0-PLC ±		PRODUCT SPEC	SIZE	CAGE CODE	DRAWING NO
1-PLC ± ±0.3		APPLICATION SPEC	A2	00779	C=2822979
2-PLC ± ±3		WEIGHT	RESTRICTED TO		
3-PLC ± ±		CUSTOMER DRAWING	SCALE NTS SHEET 6 OF 7 REV C		
4-PLC ± ±					
ANGLES ± ±					
FINISH					

THIS DRAWING IS UNPUBLISHED. RELEASED FOR PUBLICATION  
 © COPYRIGHT - Tyco Electronics JAPAN G.K. ALL RIGHTS RESERVED.

LOC	DIST	REVISIONS					
ES	-	P	LTR	DESCRIPTION	DATE	DWN	APVD
		-	-	SEE SHEET 1	-	-	-

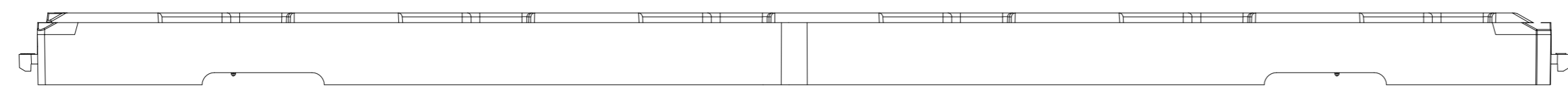
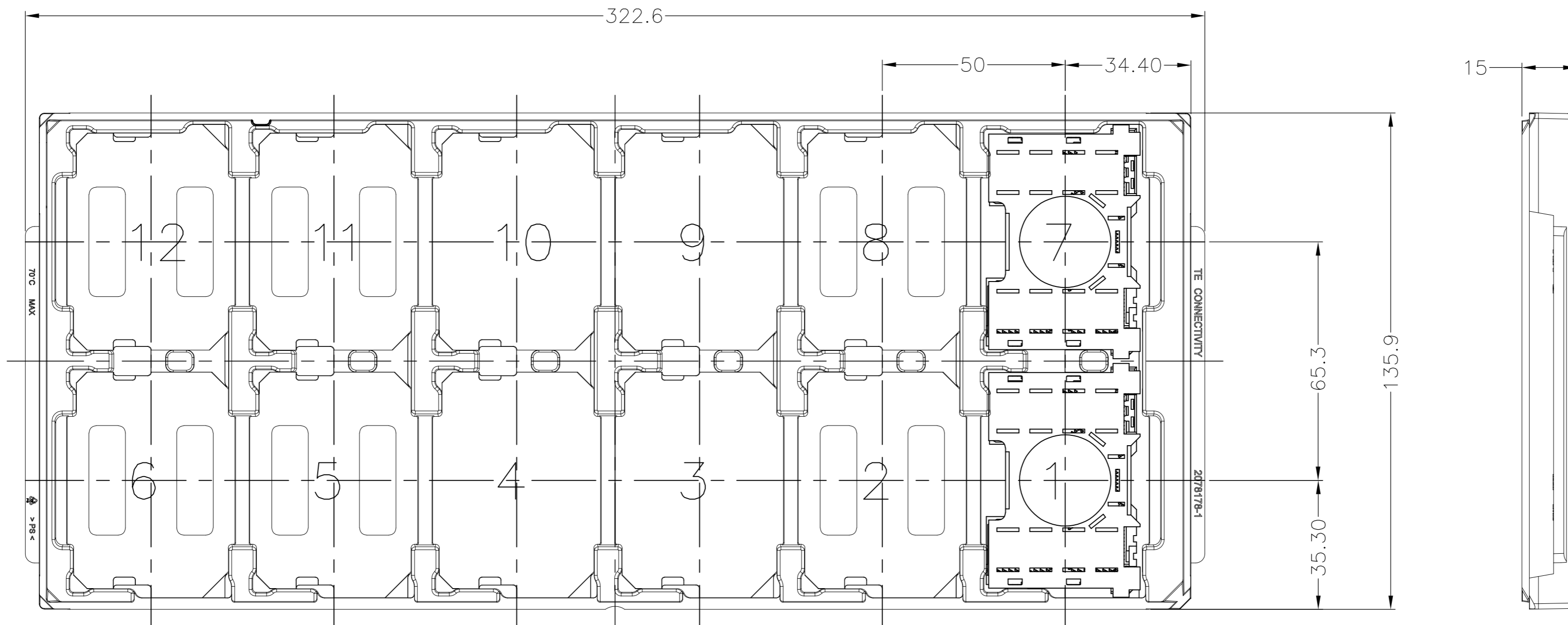

FOR LEFT SEGMENT, USE BLACK TRAY TO PACKAGE.  
 FOR RIGHT SEGMENT, USE BLUE TRAY TO PACKAGE.

SOCKET QTY(KIT) PER OUTER BOX	SOCKET QTY PER INNER BOX	SOCKET QTY PER TRAY	ASSY PART NUMBER	ORDER PART NUMBER	PRODUCT NAME
84	84	12	2822980-4	2-2822979-4	LGA3647-1 RIGHT SEGMENT
	84	12	1-2822980-4		LGA3647-1 LFFT SEGMENT
84	84	12	2822980-3	2-2822979-3	LGA3647-0 RIGHT SEGMENT
	84	12	1-2822980-3		LGA3647-0 LFFT SEGMENT
84	84	12	2822980-2	2-2822979-2	LGA3647-1 RIGHT SEGMENT
	84	12	1-2822980-2		LGA3647-1 LFFT SEGMENT
84	84	12	2822980-1	2-2822979-1	LGA3647-0 RIGHT SEGMENT
	84	12	1-2822980-1		LGA3647-0 LFFT SEGMENT

THIS DRAWING IS A CONTROLLED DOCUMENT.

DWN	-	 TE Connectivity	PRODUCT SPEC APPLICATION SPEC		
CHK	-		NAME SOCKET ASSY LGA3647-X		
APVD	-		SIZE	CAGE CODE	DRAWING NO
DIMENSIONS: mm TOLERANCES UNLESS OTHERWISE SPECIFIED: 0-PLC ± 1-PLC ±0.5 2-PLC ± 3-PLC ±3.5 4-PLC ± ANGLES ± FINISH			WEIGHT A2	00779	C-2822979
MATERIAL -		CUSTOMER DRAWING		RESTRICTED TO - SCALE NTS SHEET 7 of 7 REV C	

## X-ON Electronics

Largest Supplier of Electrical and Electronic Components

*Click to view similar products for [IC & Component Sockets](#) category:*

*Click to view products by [TE Connectivity](#) manufacturer:*

Other Similar products are found below :

[0066-3-17-15-30-14-02-0](#) [670](#) [672](#) [673](#) [694-13-640-00-672-000](#) [712-93-120-41-001000](#) [714-93-104-31-018000](#) [8059-4G1-LF](#) [807-22-001-10-001101](#) [807-22-001-10-006101](#) [807-22-001-30-011101](#) [807-22-001-30-012101](#) [807-22-001-30-013101](#) [807-22-001-30-014101](#) [8-1437531-4](#) [8150-6P10](#) [833-93-034-10-001000](#) [851-41-006-10-001000](#) [851-43-008-20-001000](#) [851-43-014-20-001000](#) [851-93-006-20-001000](#) [851-93-010-20-001000](#) [853-43-020-10-001000](#) [86.010.0053.0](#) [116-43-308-41-007000](#) [PX-68LCC](#) [121-13-318-41-001000](#) [121-13-320-41-001000](#) [121-13-308-41-001000](#) [123-43-314-41-801000](#) [123-43-420-41-001000](#) [122-13-316-41-001000](#) [123-13-624-41-001000](#) [123-43-306-41-001000](#) [12-3513-11](#) [123-91-320-41-001000](#) [126-43-310-41-002000](#) [AKSUN 37V-T](#) [1437503-9](#) [1437504-1](#) [146-44-308-41-013000](#) [146-43-308-41-012000](#) [160-10-308-00-001000](#) [160-40-320-00-001000](#) [214-99-306-01-670800](#) [232-1270-02-0602](#) [2-382761-4](#) [2-5331677-4](#) [2-640360-3](#) [2801-2-00-50-00-00-07-0](#)