

THIS DRAWING IS UNPUBLISHED. RELEASED FOR PUBLICATION  
 © COPYRIGHT - By - ALL RIGHTS RESERVED.

REVISIONS				
P	LTR	DESCRIPTION	DATE	APVD
E		REVISED PER ECO-18-001882	13FEB2018	AP DG

NOTE:

- MATERIAL:  
 HOUSING: PBT WITH 20% GF UL 94 V-0, BLACK COLOR  
 CONTACTS: PHOSPHOR BRONZE.  
 SHELL: STEEL.  
 SCREW: BRASS.  
 SCREW LOCK: BRASS.  
 SCREW TORQUE: 5kgf-cm MAX.
- FINISH:  
 CONTACTS: GOLD PLATED ON CONTACT AREA,  
 0.375µm [15µ"] MIN. MATTE TIN ON SOLDER TAIL  
 2.54µm [100µ"], WITH ENTIRE CONTACT  
 UNDERPLATED 1.27µm [50µ"] MIN. NICKEL.  
 FRONT SHELL: 2.54µm [100µ"] MIN. NICKEL PLATED.  
 REAR SHELL: 1.27µm [50µ"] MIN NICKEL UNDERPLATE.  
 2.54µm [100µ"] MIN BRIGHT TIN PLATE  
 SCREW LOCK: 1.27µm [50µ"] MIN. NICKEL PLATED.  
 BOARDLOCK: 1.27µm [50µ"] MIN NICKEL UNDERPLATE.  
 1.27µm [50µ"] MIN MATTE TIN PLATE
- WAVE SOLDER CAPABLE TO 265°C PER TE TEST SPEC. 109-202, CONDITION B.

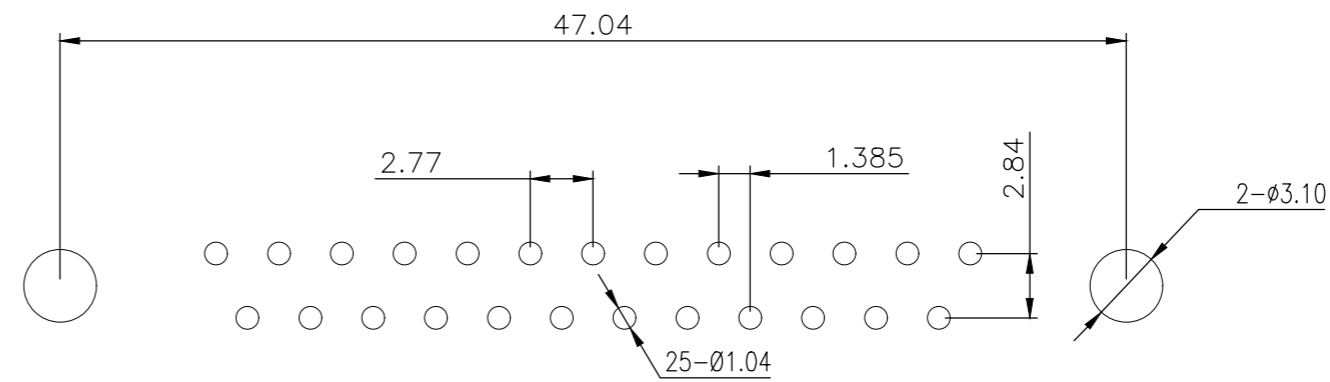
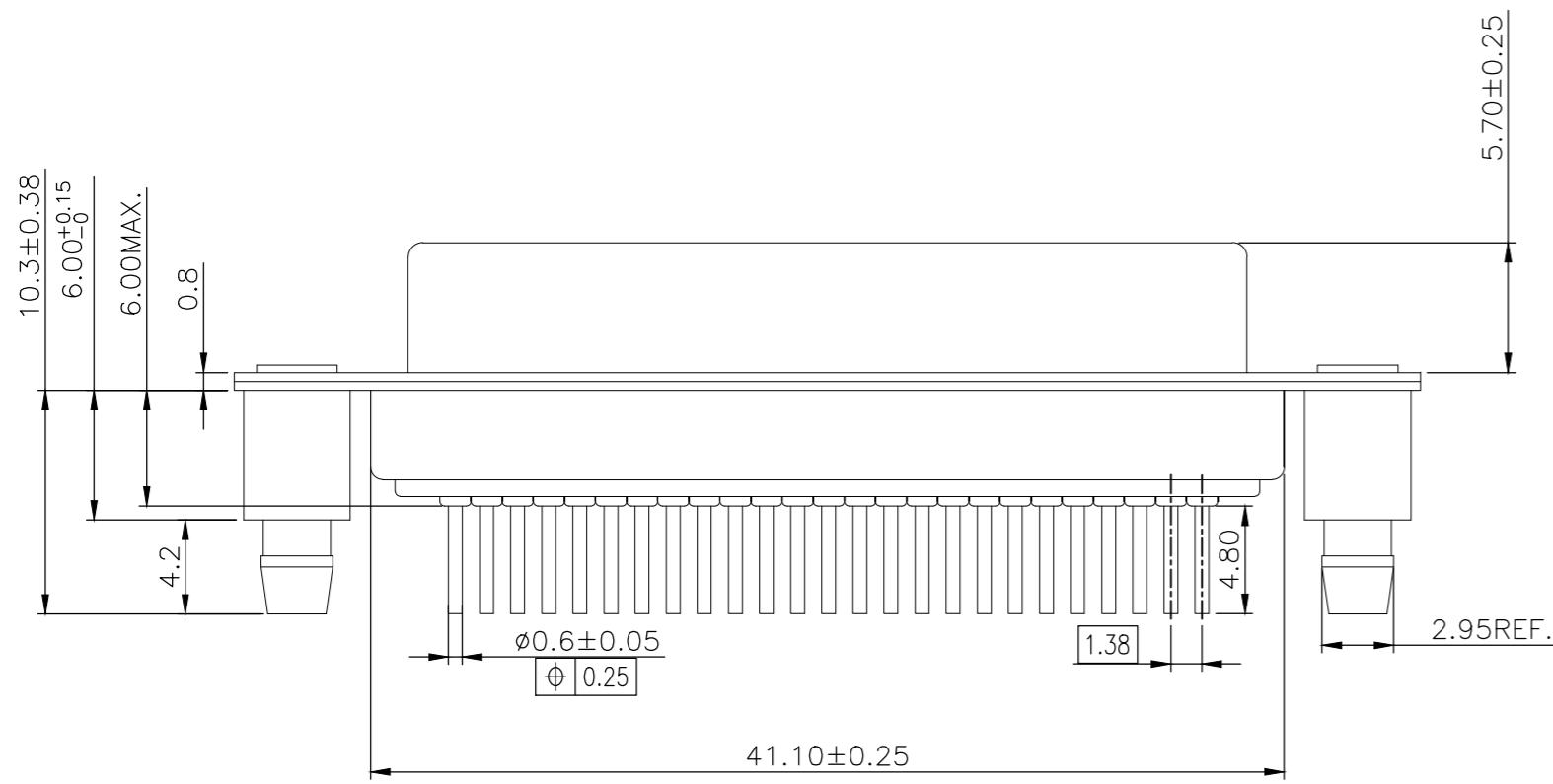
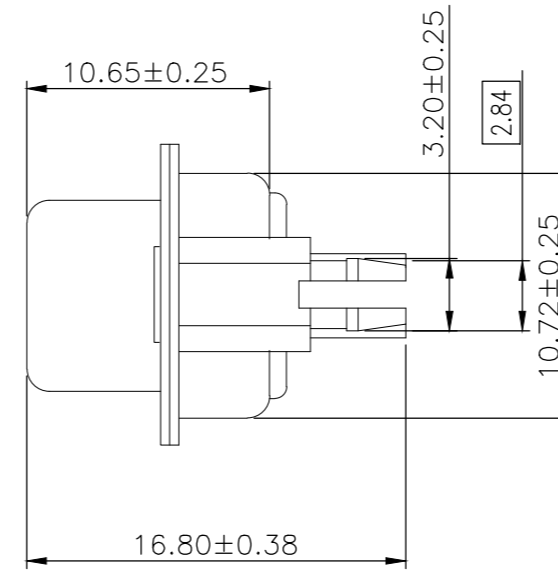
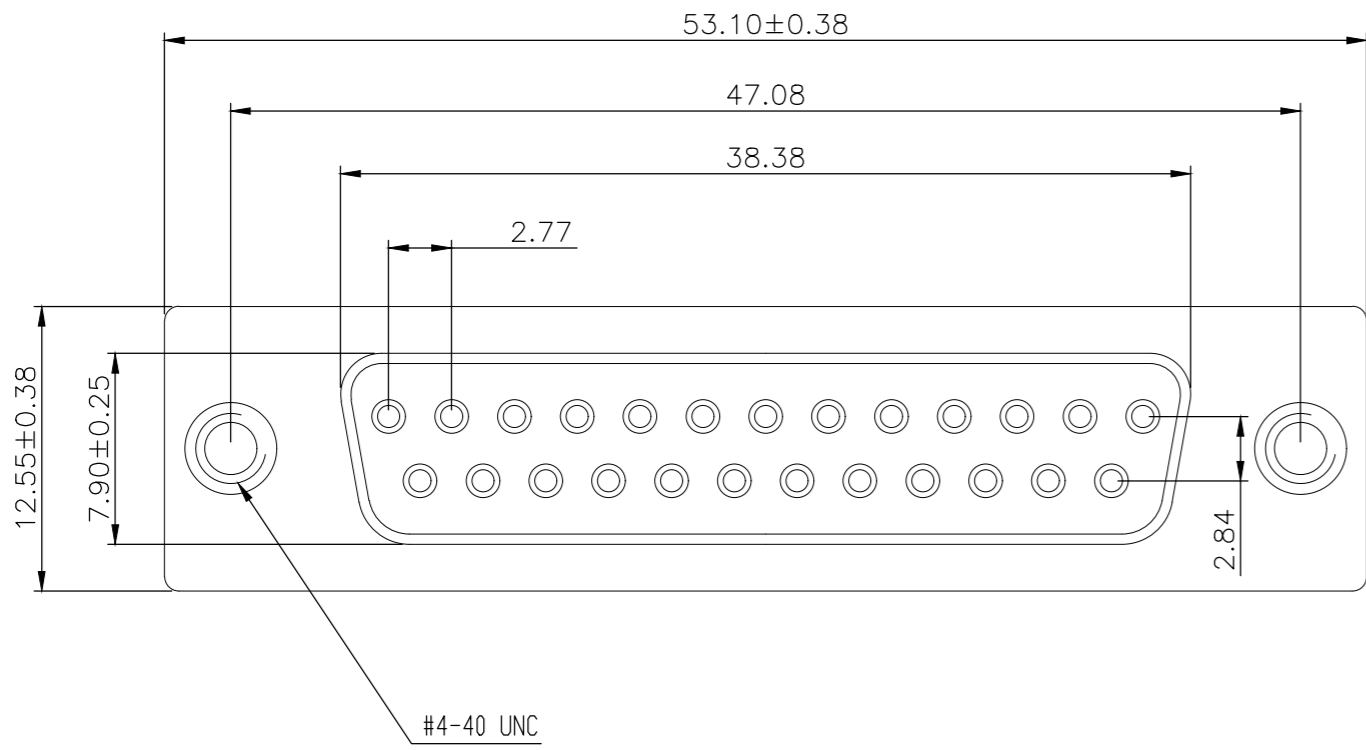

RECOMMENDED PCB LAYOUT

2301841

THIS DRAWING IS A CONTROLLED DOCUMENT.		DWN	AJITH PAI	07FEB2017
DIMENSIONS:		CHK	DAN GORENC	07FEB2017
mm	TOLERANCES UNLESS OTHERWISE SPECIFIED:	APVD	-	07FEB2017
	0 PLC	±	-	PRODUCT SPEC
	1 PLC	±	0.25	108-130013
	2 PLC	±	0.15	APPLICATION SPEC
	3 PLC	±	-	-
MATERIAL	FINISH	WEIGHT	0	CUSTOMER DRAWING
-	-	SCALE	3:1	SHEET 1 of 4

25w D skt W B/L & 4-40 inserts 15u" gold		2301841-1	
DESCRIPTION		TE PART NO	
<b>TE</b> TE Connectivity			
D-SUB VERTICAL 25P SKT CONNECTOR			
SIZE	CAGE CODE	DRAWING NO	RESTRICTED TO
A2	00779	C=2301841	-
SCALE		SHEET	REV
3:1		1 of 4	E

THIS DRAWING IS UNPUBLISHED. RELEASED FOR PUBLICATION  
 © COPYRIGHT - By - ALL RIGHTS RESERVED.

REVISIONS					
P	LTR	DESCRIPTION	DATE	DWN	APVD
-	-	SEE SHEET 1	-	-	-

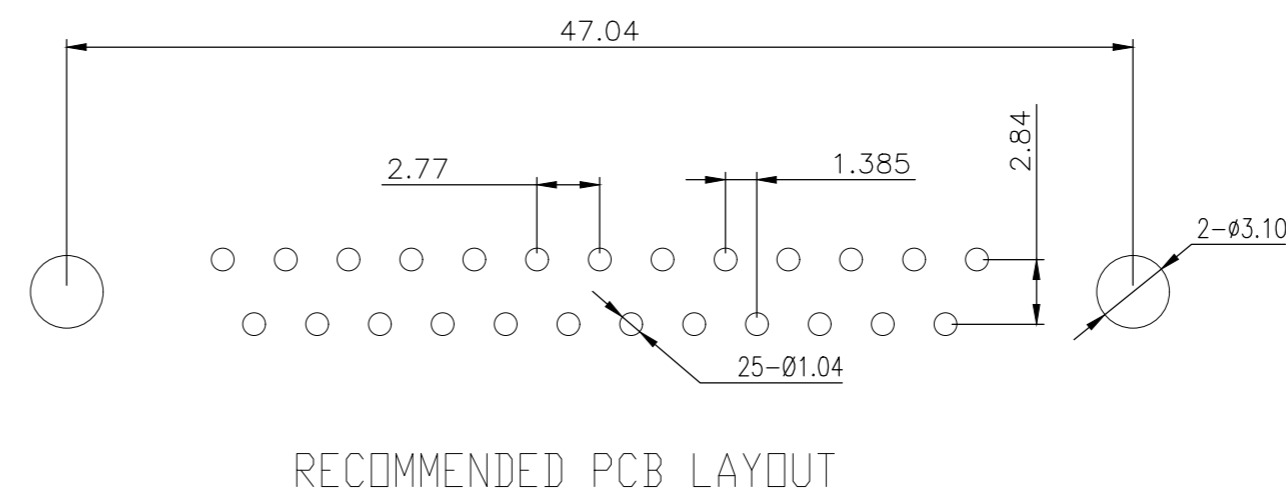
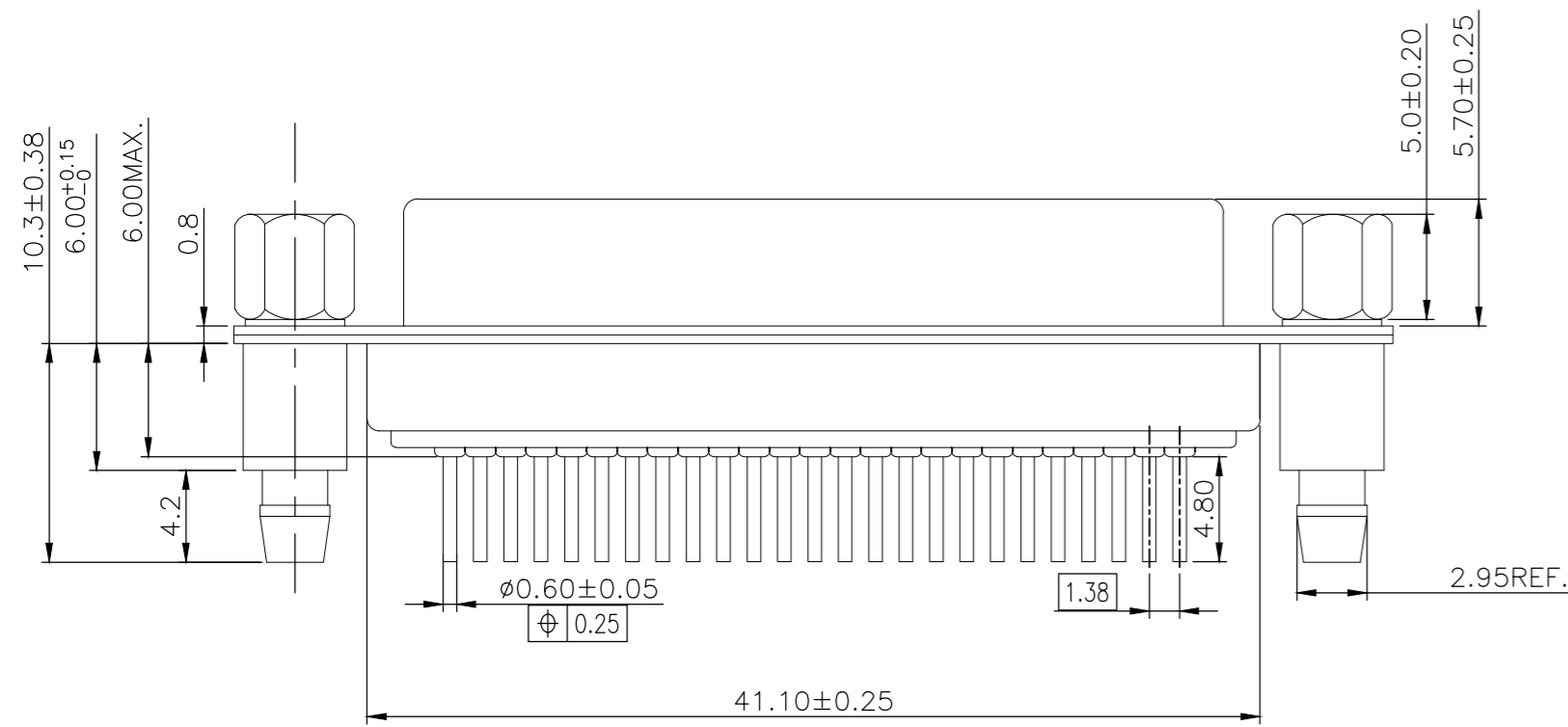
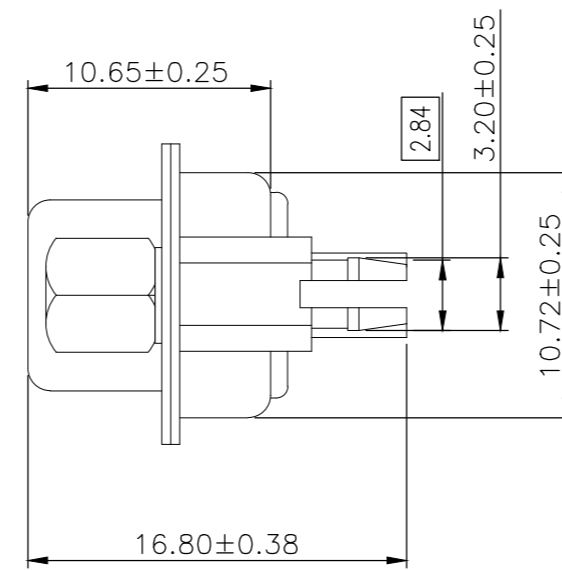
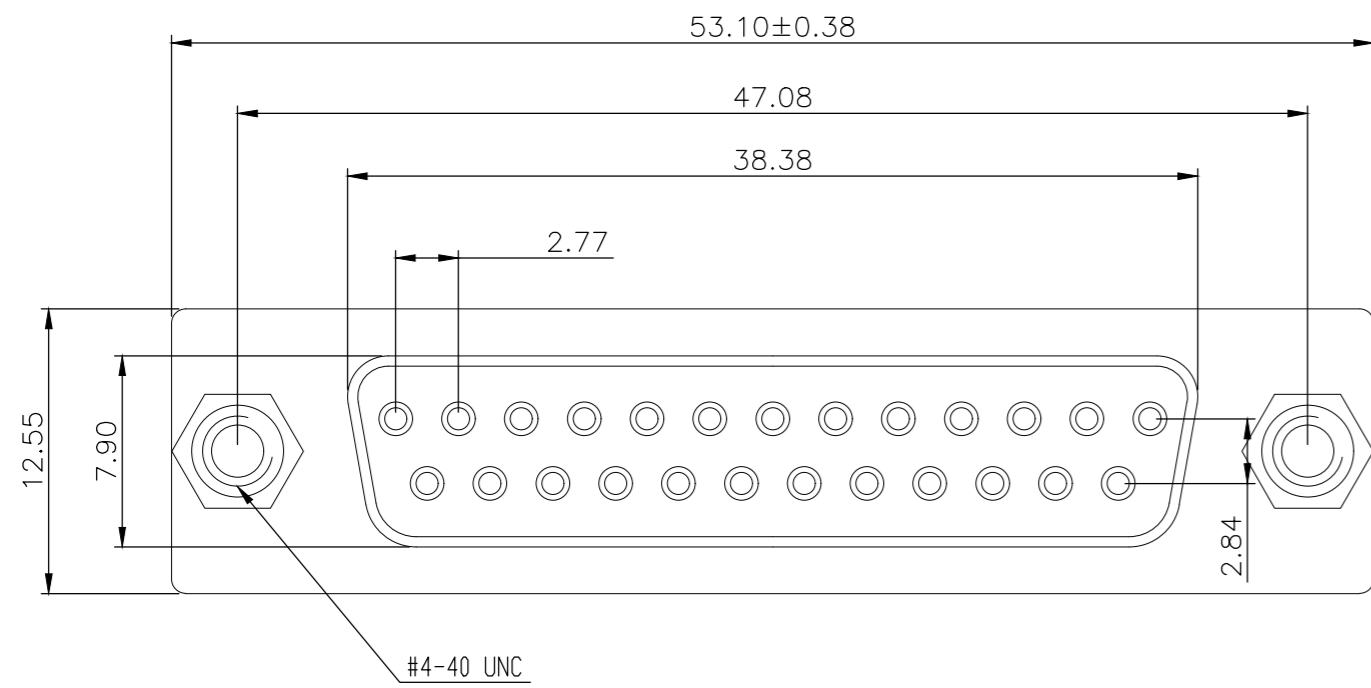

THIS DRAWING IS A CONTROLLED DOCUMENT.		DWN	AJITH PAI	07FEB2017
DIMENSIONS:		CHK	DAN GORENC	07FEB2017
mm	TOLERANCES UNLESS OTHERWISE SPECIFIED:	APVD	-	07FEB2017
	0 PLC	±	-	PRODUCT SPEC
	1 PLC	±	0.25	108-130013
	2 PLC	±	0.15	APPLICATION SPEC
	3 PLC	±	-	-
MATERIAL	FINISH	WEIGHT	0	CUSTOMER DRAWING
-	-	SCALE	3:1	SHEET
		RESTRICTED TO	-	REV
				E

25w D skt W B/L & 4-40 s/lock 15u" gold		2301841-2	
DESCRIPTION		TE PART NO	
<b>TE</b> TE Connectivity			
D-SUB VERTICAL 25P SKT CONNECTOR			
SIZE	CAGE CODE	DRAWING NO	RESTRICTED TO
A2	00779	C=2301841	-
SCALE		SHEET	REV
3:1		2 of 4	E

2301841

THIS DRAWING IS UNPUBLISHED. RELEASED FOR PUBLICATION  
 © COPYRIGHT - By - ALL RIGHTS RESERVED.

REVISIONS					
P	LTR	DESCRIPTION	DATE	DWN	APVD
-	-	SEE SHEET 1	-	-	-

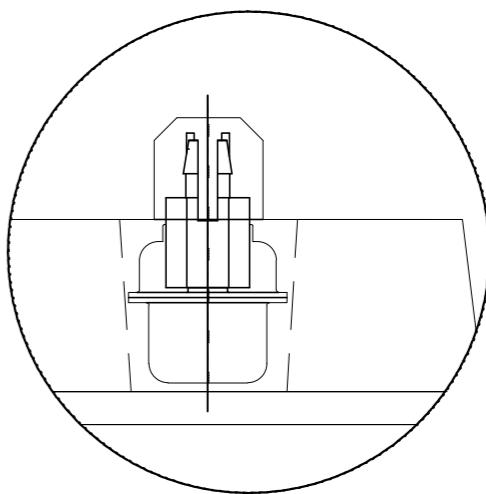
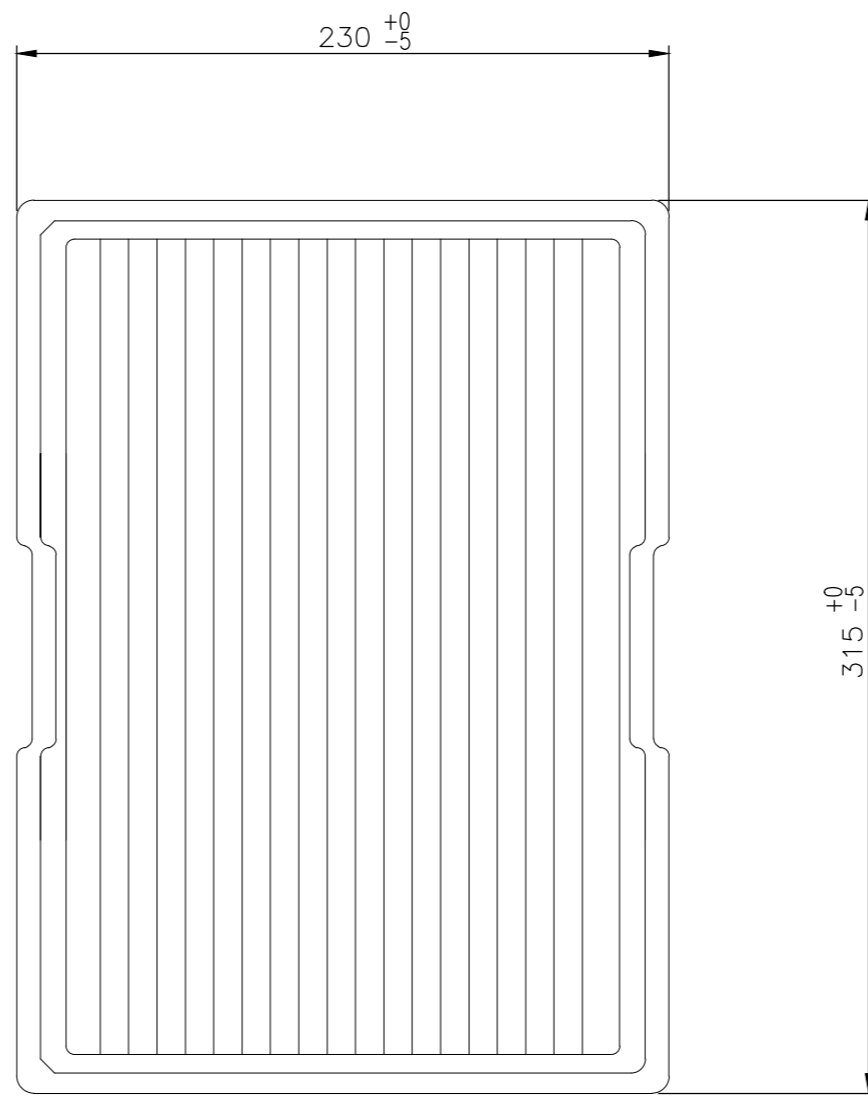
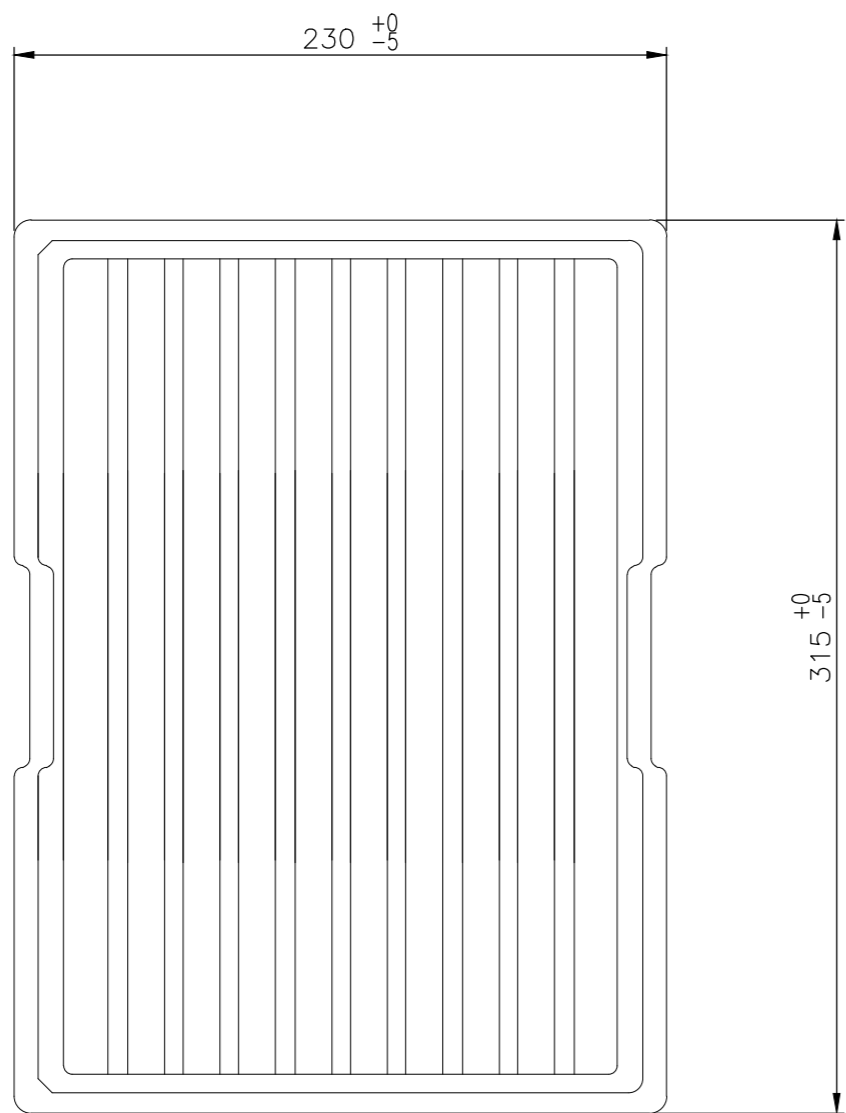
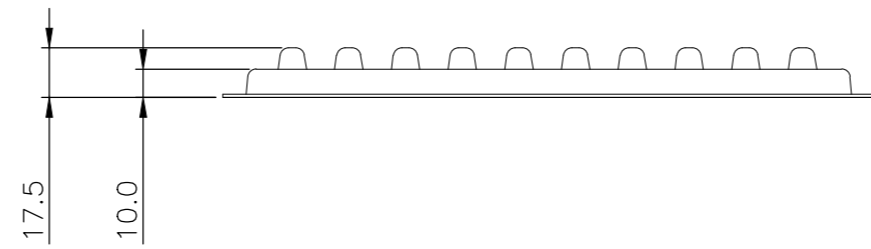
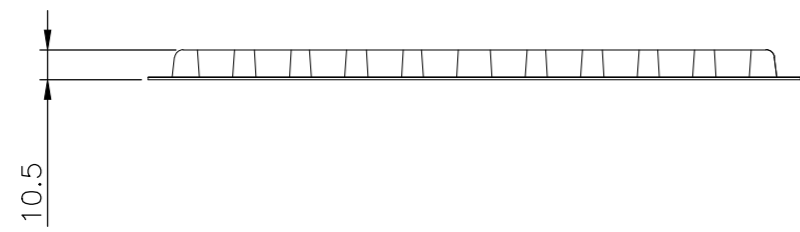

DETAIL A

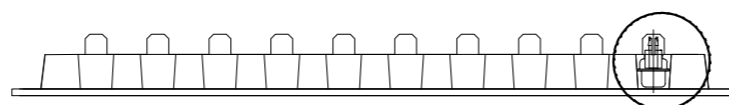

SEE DETAIL A

THIS DRAWING IS A CONTROLLED DOCUMENT.		DWN AJITH PAI 07FEB2017			
		CHK DAN GORENC 07FEB2017			
		APVD - 07FEB2017	NAME		
DIMENSIONS: mm		PRODUCT SPEC 108-130013		D-SUB VERTICAL 25P SKT CONNECTOR	
TOLERANCES UNLESS OTHERWISE SPECIFIED:		APPLICATION SPEC		RESTRICTED TO	
0 PLC ± -		-		-	
1 PLC ± 0.25		-		-	
2 PLC ± 0.15		-		-	
3 PLC ± -		-		-	
4 PLC ± -		-		-	
ANGLES ± -		-		-	
MATERIAL		WEIGHT 0		SIZE A2	
FINISH		CUSTOMER DRAWING		CAGE CODE 00779	
		SCALE 1:1		DRAWING NO C=2301841	
		SHEET 3 of 4		REV E	

THIS DRAWING IS UNPUBLISHED. RELEASED FOR PUBLICATION  
 © COPYRIGHT - By - ALL RIGHTS RESERVED.

REVISIONS					
P	LTR	DESCRIPTION	DATE	DWN	APVD
-	-	SEE SHEET 1	-	-	-

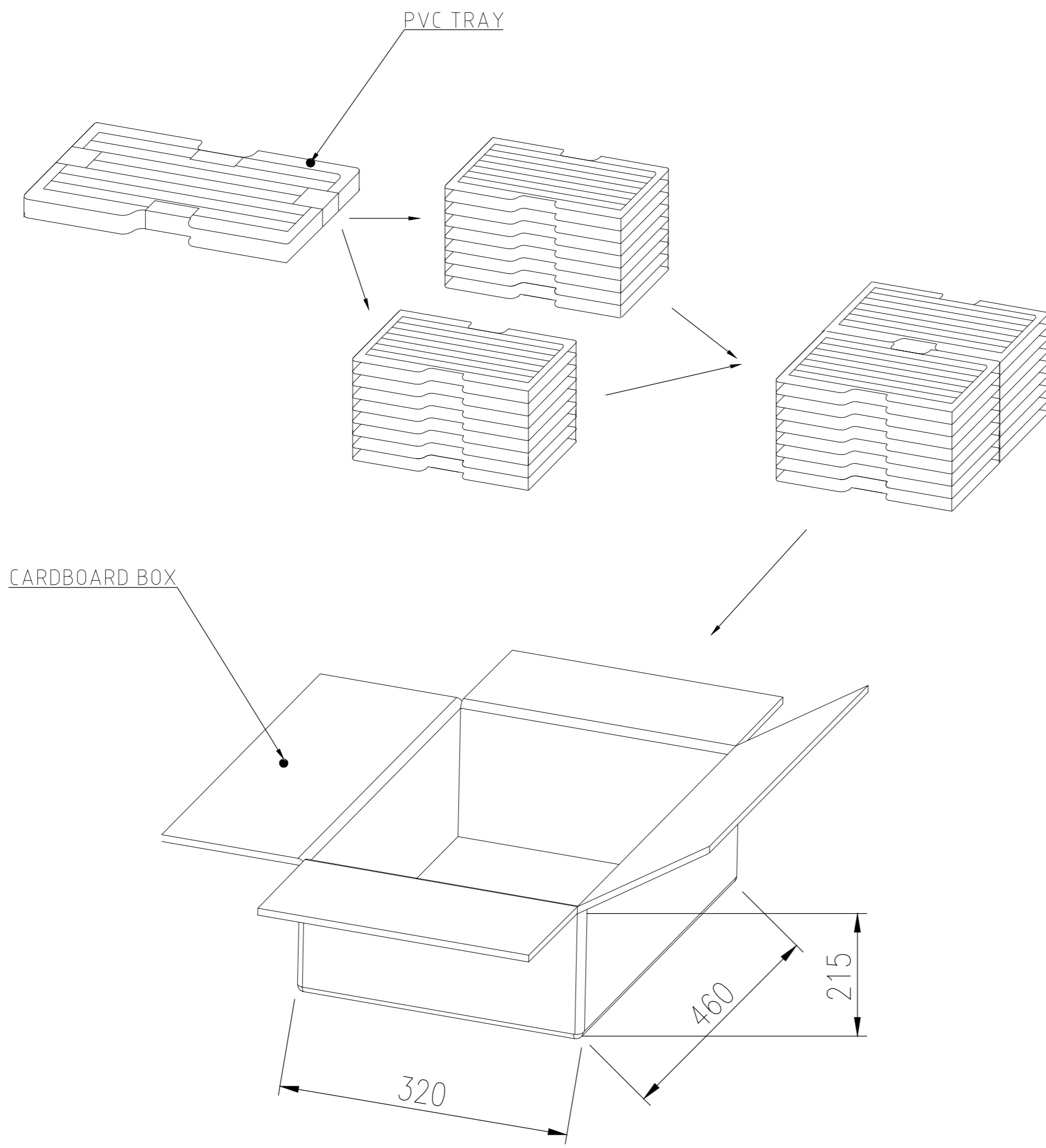

15.979	13.400	50	20	1000	2301841-2
14.479	11.900	50	20	1000	2301841-1
GROSS WEIGHT (Kg)	NET WEIGHT (Kg)	PCS/TRAY	TRAYS /CARTON	QUANTITY PCS	PART NUMBER

THIS DRAWING IS A CONTROLLED DOCUMENT.		DWN	07FEB2017	 TE Connectivity D-SUB VERTICAL 25P SKT CONNECTOR	
DIMENSIONS: mm		CHK	07FEB2017		
TOLERANCES UNLESS OTHERWISE SPECIFIED:		APVD	07FEB2017		
0 PLC ± - 1 PLC ± 0.25 2 PLC ± 0.15 3 PLC ± - 4 PLC ± - ANGLES ± -		PRODUCT SPEC	108-130013		
MATERIAL		WEIGHT		SIZE	RESTRICTED TO
-		0		A2 00779	-
FINISH		CUSTOMER DRAWING		CAGE CODE	DRAWING NO
-		-		C=2301841	-
		SCALE		SHEET	REV
		1:1		4 of 4	E

## X-ON Electronics

Largest Supplier of Electrical and Electronic Components

*Click to view similar products for [D-Sub Standard Connectors](#) category:*

*Click to view products by [TE Connectivity](#) manufacturer:*

Other Similar products are found below :

[56F711-015](#) [012-9507-004](#) [LV242999-142T12](#) [015-0341-000](#) [015-0372-005](#) [015-0372-008](#) [015-8755-001](#) [020419-0104](#) [012-0467-000](#) [012-0515-000](#) [012-9507-034](#) [012-9507-114](#) [020745-0008](#) [609-25P](#) [M24308/2-23Z](#) [CT2-14S-2PCA34](#) [CT2-18-11PCAU](#) [CT2-36-15SC](#) [CT6-14S-2SC](#) [CT6E14SA7SC](#) [CT6E22-14PC](#) [CT6E22-14PS](#) [CT6E22-22PS](#) [M83513/01-FC](#) [M85049/48-3-2F](#) [6STD09PCM99B70X](#) [6STD09SCM99B30X](#) [6STD09SCT99S40X](#) [6STD15PCT99S40X](#) [6STD15SCM99B30X](#) [6STD15SCT99S40X](#) [6STF09PCM05B70X](#) [7-135760-9](#) [MC11E-10-6SN](#) [747552-3](#) [MD1-21PS](#) [MDM-15SCBRM7-F222](#) [MDM96517-699](#) [MDM96521-744](#) [MDVB1-21SL1](#) [MIK0-1-7SH003](#) [MIKQ6-7SH076](#) [MIKQ7-7PH077](#) [MIKQ7-7PH11](#) [MIKQ7-7PH32](#) [MJSV-28SL61](#) [MKJ4A1F14-55S](#) [8-135760-3](#) [8STD09PCM99B30X](#) [PG-KV/PV-16-GROM-SEALING](#)