

REVISIONS

P	LTR	DESCRIPTION	DATE	DWN	APVD
	A	RELEASED	13DEC2017	RI	EI
	A1	REVISED PER ECR-18-009643	21JUN2018	TS	EI
	A2	REVISED PER ECR-19-005449	22APR2019	DW	CW

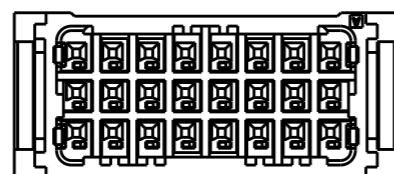
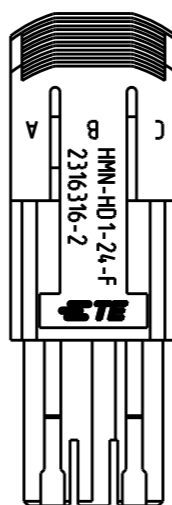
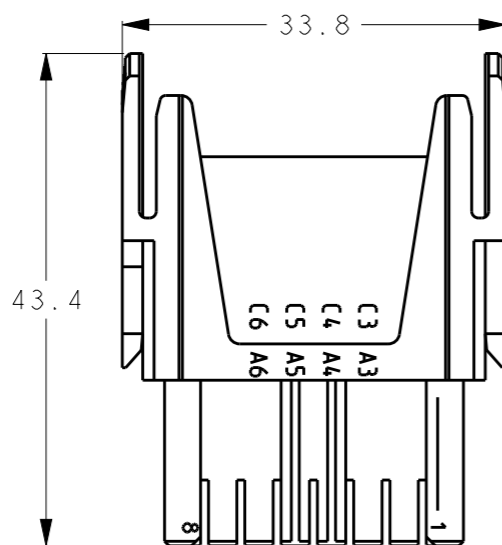
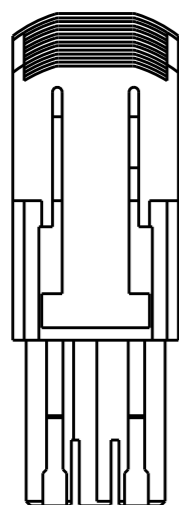
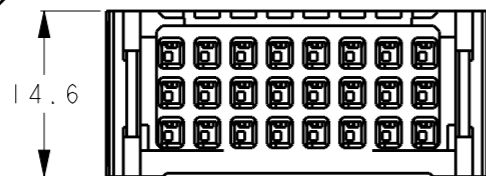
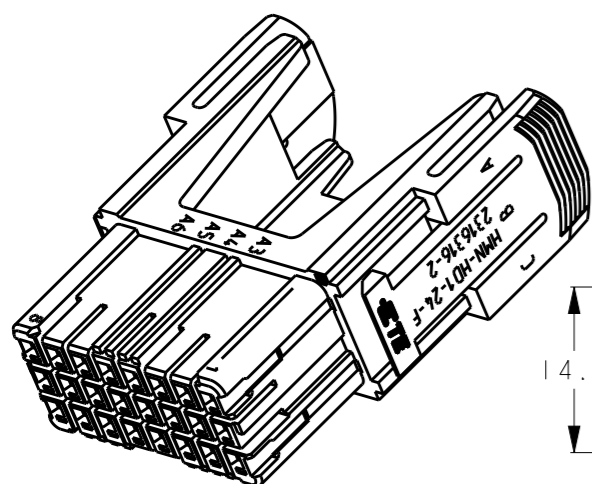

- TECHNICAL CHARACTERISTICS :
 INSULATION MATERIAL : PBT
 RATED VOLTAGE : 300V
 RATED CURRENT : 3.7A
 INSULATION RESISTANCE : $\geq 100M\Omega$
 RATED IMPULSE VOLTAGE : 4KV
 POLLUTION DEGREE : 3
 FLAMMABILITY : UL94V-0
 MATING CYCLES : SEE TABLE 1
 OPERATION TEMPERATURE : $-40^{\circ}C \sim +125^{\circ}C$
 WIRE RANGE : 0.05 SQmm~0.87 SQmm
 CONTACT TYPE : CRIMP CONTACT
- CONTACT NEED TO BE ORDERED SEPARATELY.
 (ORDER No. REFER TO DRAWING : SEE TABLE 1)
- FRAMES NEED TO BE ORDERED SEPARATELY.
 (ORDER No. REFER TO DRAWING : SEE TABLE 2)

TABLE 1

MATING CYCLES	INSULATION RANGE	WIRE RANGE	SIZE	PART NUMBER		DESCRIPTION
				REEL	L/P	
500	1.4-2.2	AWG22-18, 0.34-0.87SQmm	2L	1-2316670-4	-	HDI RECEPTACLE CONTACT
	1.4-2.2	AWG22-18, 0.34-0.87SQmm	2L	2316670-4	2316671-4	
	1.08-1.9	AWG28-22, 0.08-0.37SQmm	L	2316670-3	2316671-3	
	1.08-1.6	AWG28-22, 0.08-0.37SQmm	M	2316670-2	2316671-2	
	0.6-1.2	AWG30-28, 0.05-0.10SQmm	S	2316670-1	2316671-1	

TABLE 2

DESCRIPTION	PART NUMBER
H24B FEMALE FRAME FOR 6 MODULES	T2070244201-002
H16B FEMALE FRAME FOR 4 MODULES	T2070164201-002
H10B FEMALE FRAME FOR 3 MODULES	T2070104201-002
H6B FEMALE FRAME FOR 2 MODULES	T2070064201-002
H10A FEMALE FRAME FOR 1 MODULE	T2079104201-002

2316316-2
PART NUMBER

THIS DRAWING IS A CONTROLLED DOCUMENT.		DWN R. ITO 13DEC2017	 TE Connectivity	
DIMENSIONS: mm		CHK T. SHIMOYASU 13DEC2017		
TOLERANCES UNLESS OTHERWISE SPECIFIED:		APVD F. IKEMATSU 13DEC2017	NAME MODULE INSERT HMN-HD1-24-F HDC DYNAMIC	
0 PLC ±0.5 1 PLC ±0.5 2 PLC ±0.5 3 PLC ±0.5 4 PLC ±0.5 ANGLES ±5°		PRODUCT SPEC 108-140157	RESTRICTED TO	
MATERIAL SEE NOTE		FINISH -	APPLICATION SPEC 114-78025	SCALE 3:2
		WEIGHT 13.0g	SIZE A3	CAGE CODE -
		CUSTOMER DRAWING	DRAWING NO C-2316316	SHEET 1 OF 1
				REV A2

X-ON Electronics

Largest Supplier of Electrical and Electronic Components

Click to view similar products for [Rectangular MIL Spec Connectors](#) category:

Click to view products by [TE Connectivity](#) manufacturer:

Other Similar products are found below :

[891-011-15SA2-BSST](#) [CTS-S16/16](#) [65002-062](#) [CY4602-000](#) [732-8020-01](#) [77058-22-55PN](#) [81542-20](#) [86.030.0053.0](#) [1241346-1](#) [RM252-020-311-2900](#) [DMC-M 08-16 SA](#) [DMC-M 08-16 SAE](#) [1589051-4](#) [MSO34MPK1E1](#) [BACC65CAMA](#) [BACC65CP1PN](#) [BACI10BC0816PNBA](#) [HSB-D4S03DM222X](#) [2217548-1](#) [891-006-9PS-BST1T](#) [891-009-15SA2-BRT1T](#) [27963-20T12](#) [SIM2N40NC3](#) [SIM2S100A](#) [1604996-2](#) [SMD25PN90L-4055](#) [1900ND08S1B00A](#) [22628-10-6P-791](#) [GMCT50F0T0000](#) [RE04-212S](#) [M32139/03-G05SN](#) [CTD160E01F-6148](#) [CTJ112E03B](#) [CTJ122E02D-8000](#) [CTJ-3D-12](#) [CTJ920E06N-513](#) [CTJ920E12N-513](#) [CTL-16-090](#) [CY4600-000](#) [CY4601-000](#) [38111-14-15SN](#) [38112-14-15PN](#) [MMA23-0111R1](#) [MMD25-0071P1](#) [33516062020](#) [33526M11-08PE](#) [DMC-M99-01AN](#) [Y59113WE20PNV00300](#) [ZPF000000000106310](#) [105979-31](#)