

REVISIONS				
P.	LTN	DESCRIPTION	DATE	APVD
C		REV PER ECO 20-002853	3-3-20	CT DM

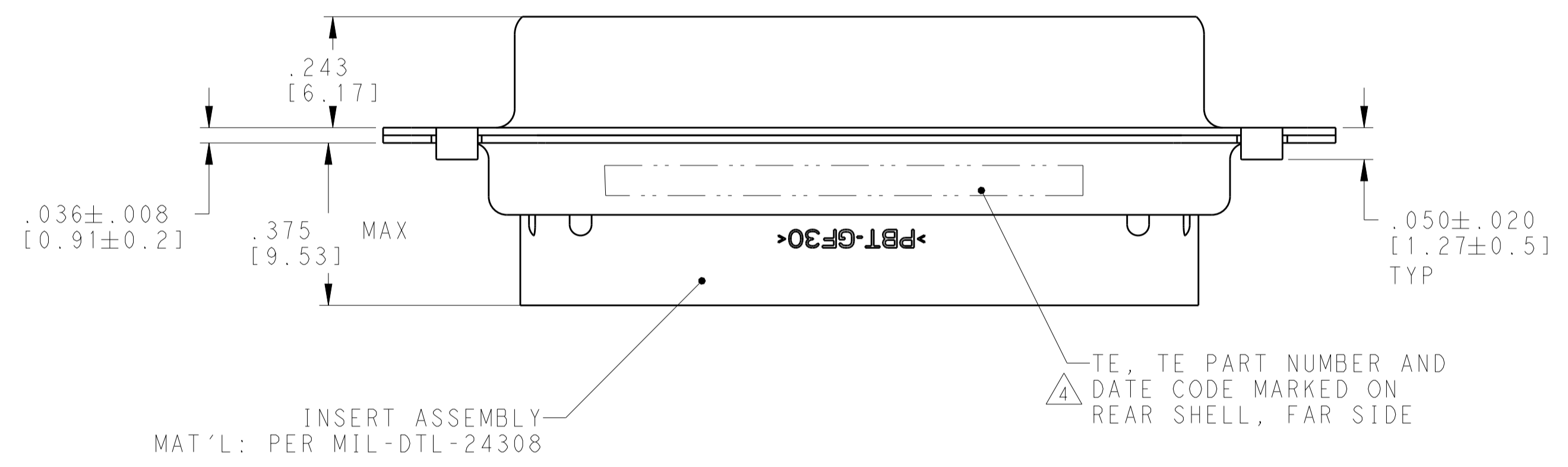
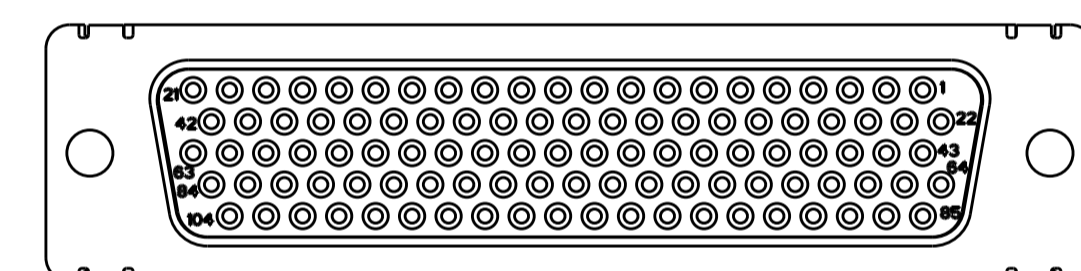
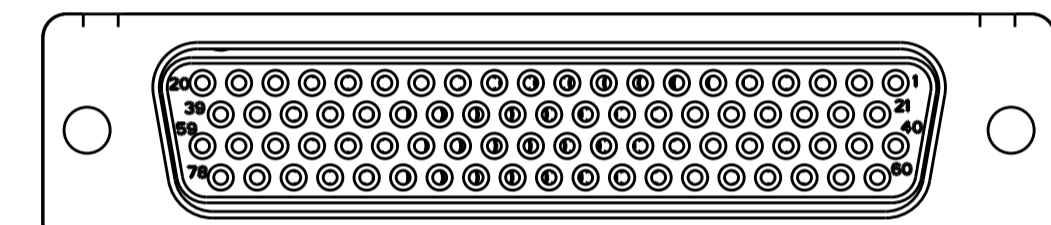
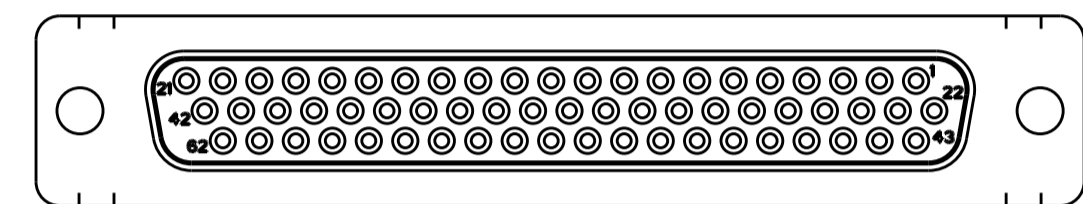
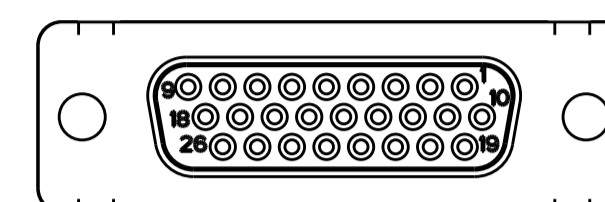
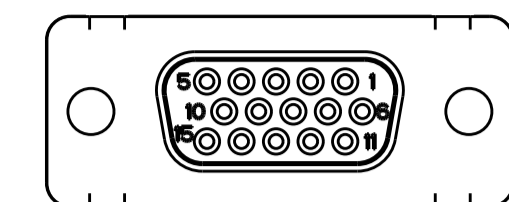
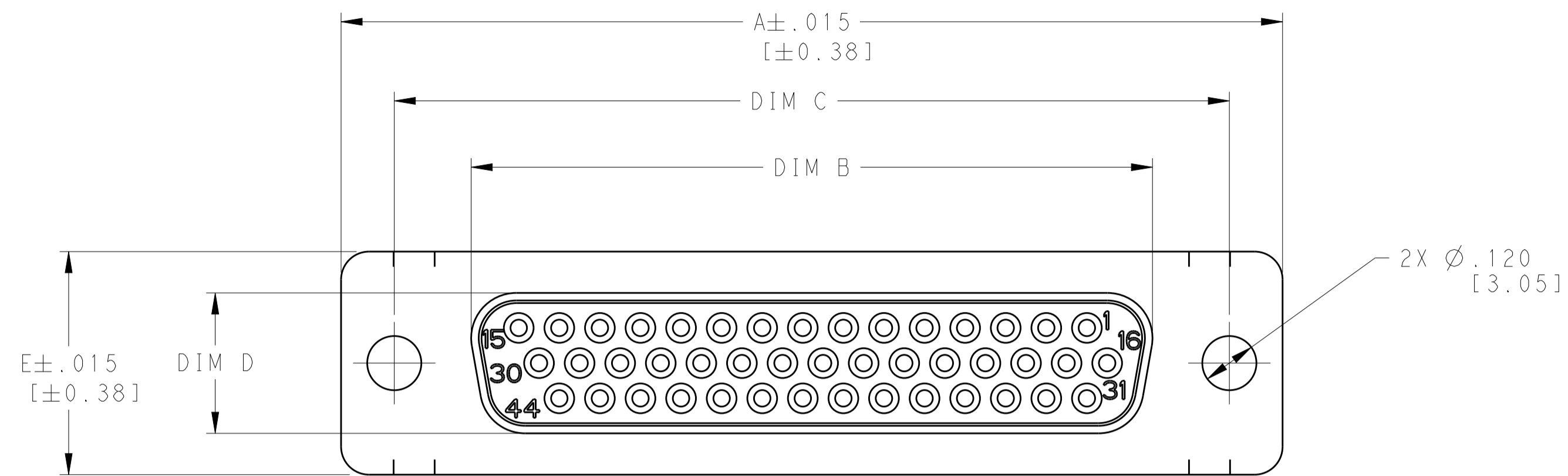

2335893-3 SHOWN

- THIS ASSEMBLY IS DESIGNED TO CONFORM TO THE LATEST ISSUE OF MIL-DTL-24308
  - METAL RETENTION CLIPS ARE INCLUDED IN INSERTS.
  - THIS RECEPTACLE WILL ACCEPT SIZE 22 SOCKET CONTACTS M39029/57-354 TE CONNECTIVITY PART NO. 204351-1. CONTACTS ARE NOT INCLUDED AND MUST BE ORDERED SEPARATELY.
- MARKED WITH .047-.062 HIGH CHARACTERS. FAR SIDE REFERS TO THE WIDE SIDE OF THE KEYSTONE. NEAR SIDE REFERS TO THE NARROW SIDE OF THE KEYSTONE. IF THE REAR SHELL IS TOO SMALL FOR TE, TE PART NUMBER AND DATE CODE, THEN SPLIT AS FOLLOWS:  
 A: TE PART ON REAR SHELL, NEAR SIDE  
 B: TE AND DATE CODE ON REAR SHELL, FAR SIDE

	WITH	2335891-5	.605	.423	2.406	2.064	2.635	78	5	1-2335893-1
	WITHOUT	2335891-6	.668	.485	2.500	2.189	2.729	104	6	2335893-6
	WITHOUT	2335891-5	.605	.423	2.406	2.064	2.635	78	5	2335893-5
	WITHOUT	2335891-4	.494	.311	2.500	2.159	2.729	62	4	2335893-4
	WITHOUT	2335891-3	.494	.311	1.852	1.511	2.088	44	3	2335893-3
	WITHOUT	2335891-2	.494	.311	1.312	.971	1.541	26	2	2335893-2
	WITHOUT	2335891-1	.494	.311	.984	.643	1.213	15	1	2335893-1
	204351-1 CONTACTS	TE MATING PART NUMBER	DIM E	DIM D	DIM C	DIM B	DIM A	NUMBER OF POSITIONS	SHELL SIZE	TE PART NO.

DATE CODE IS FOUR DIGITS, FIRST TWO DIGITS REFER TO THE YEAR AND SECOND TWO DIGITS REFER TO THE WEEK.

THIS DRAWING IS A CONTROLLED DOCUMENT. DWG: C.C. THOMAS 21AUG2018  
 CHK: D. MILLER 8-21-18  
 APVD: D. MILLER 8-21-18

**STE** TE Connectivity

RECEPTACLE ASSEMBLY, SIZE 1 THRU 6  
 SERIES 90, AMPLIMITE  
 WITH STAINLESS STEEL SHELLS

SIZE: A1 00779 C=2335893  
 SCALE: 4:1 SHEET: 1 OF 1 REV: C

## X-ON Electronics

Largest Supplier of Electrical and Electronic Components

*Click to view similar products for [D-Sub High Density Connectors](#) category:*

*Click to view products by [TE Connectivity](#) manufacturer:*

Other Similar products are found below :

[97-3250-11](#) [163A16809X](#) [163A17089X](#) [164A17199X](#) [164C18629X](#) [242A25680X](#) [L717HDB44POL2R210](#) [L717HDEH15POL2](#)  
[L777HDE15P](#) [L77HDE15SC309](#) [163A16759X](#) [163A16839X](#) [163A16989X](#) [163A17079X](#) [164A17329X](#) [164A18219X](#) [241A16440X](#)  
[241A16550X](#) [241A16680X](#) [241A20810X](#) [241A25740X](#) [CT25-44P](#) [MDBE15PE766](#) [L177HDE15SOL2RM23](#) [L177HRC62SVFM](#)  
[L177HRCG62S](#) [L717HDEG15POL2RM5](#) [L77HDA26SVF](#) [L77HDE15SD1CO](#) [L77HDEH15SOL2RM832](#) [443895-3](#) [106698-1](#) [280-012K2C](#)  
[L177HRB44S](#) [164A17039X](#) [09562004701510](#) [164A17969X](#) [L777HRC62P](#) [241A17960X](#) [164A18269X](#) [L777HDEG15P](#) [280-](#)  
[018P3S25MEGN](#) [206504-2](#) [40-9515HDSP](#) [2057140-1](#) [C115370-6002](#) [DFMA104SNMBFR172FR022](#) [HDC9F200E2S](#)  
[L717HDAG26POL2RM8](#) [241A28180X](#)