

REVISIONS				
P	LTR	DESCRIPTION	DATE	APVD
	A	NEW RELEASE	26NOV2018	GCM/JDB

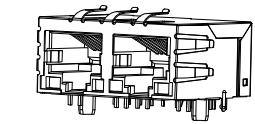
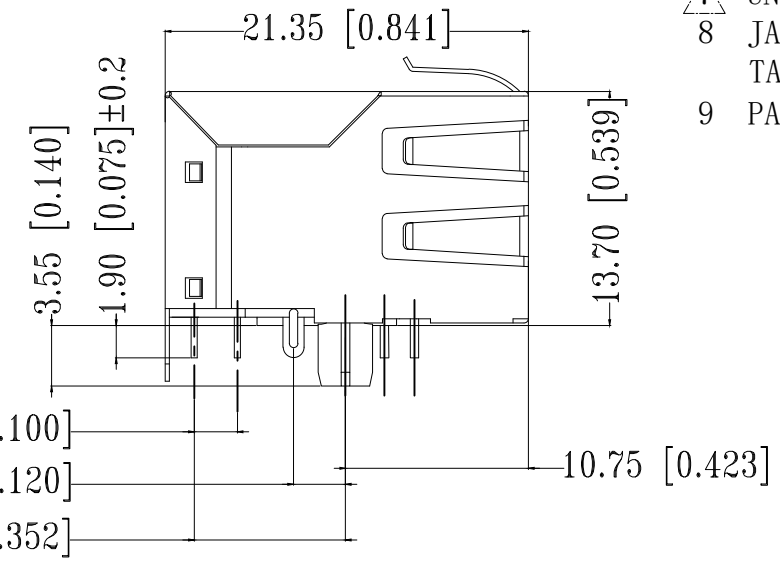
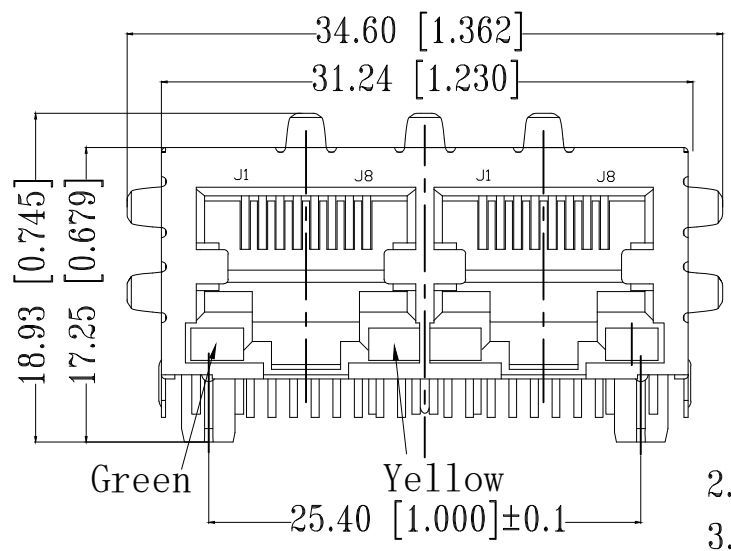
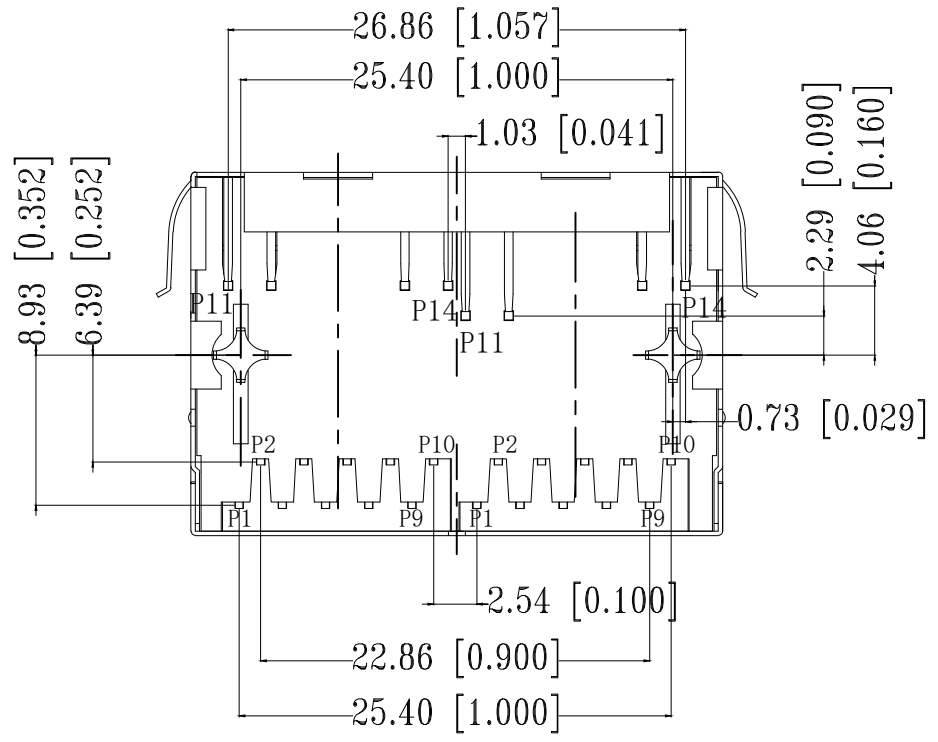

1:1

- △ CONNECTOR MATERIAL:
 HOUSING: LCP BLACK UL94 V-0
 INSERT: LCP BLACK UL94 V-0
 SHIELD: BRASS
 SHIELD PLATING: NICKEL
 CONTACT: COPPER ALLOY
 CONTACT PLATING: SELECTIVE GOLD, MIN. 0.76µm (30µinch) IN CONTACT AREA
 OVER MIN. 1.27µm (50µinch) NICKEL
- SOLDER PIN PLATING: 3.05µm (120µinch) TIN OVER 1.27µm (50µinch) NICKEL
 OVER ALL
- SHIELDING PIN PLATING: NICKEL
- 2 PIN NOT ELECTRICALLY CONNECTED MAYBE OMITTED SEE ELECTRICAL CIRCUIT DIAGRAM FOR OMITTED PINS
- 3 RJ45 CAVITIES CONFORM TO FCC RULES AND REGULATION PART 68
- 4 THE PART IS RECOMMENDED FOR REFLOW SOLDERING PROCESS PEAK SOLDERING: TEMPERATURE MAX. +260° C, MAX. 10s
- 5 OPERATING TEMPERATURE: T= -40° C TO +85° C
- 6 STORAGE TEMPERATURE: T= -40° C TO +85° C
- △ UNLESS OTHERWISE SPECIFIED, SEE TABLE FOR ALL DIMENSIONS TOLERANCES
- 8 JACK CONFIGURATION: 1 x 2
 TAB DIRECTION: DOWN
- 9 PACKAGING: REEL (T+R) ACCORDING TO PACKAGING SPECIFICATION 107-18116

TABLE OF TOLERANCE (mm)	
RANGE	TOLERANCE
0-10	±0.15
>10-40	±0.25
>40-70	±0.30
>70	±0.40

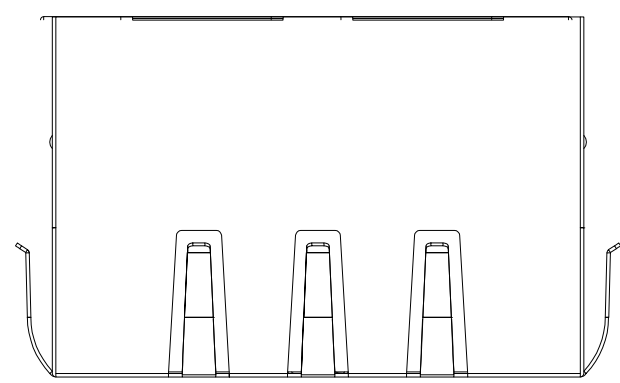

THIS DRAWING IS A CONTROLLED DOCUMENT.		DWN GANESH C M 26NOV2018	STE TE Connectivity												
DIMENSIONS: mm [INCHES]		CHK O. WIBORG 26NOV2018													
TOLERANCES UNLESS OTHERWISE SPECIFIED: <table border="0"> <tr><td>0 PLC</td><td>± -</td><td rowspan="5">△ 7</td></tr> <tr><td>1 PLC</td><td>± -</td></tr> <tr><td>2 PLC</td><td>± -</td></tr> <tr><td>3 PLC</td><td>± -</td></tr> <tr><td>4 PLC</td><td>± -</td></tr> </table>		0 PLC	± -	△ 7	1 PLC	± -	2 PLC	± -	3 PLC	± -	4 PLC	± -	APVD J. DE BRUIJN 26NOV2018	NAME RJ45 JACK MAG. POE 10/100 LED 1x2	
0 PLC	± -	△ 7													
1 PLC	± -														
2 PLC	± -														
3 PLC	± -														
4 PLC	± -														
MATERIAL △ 1		FINISH △ 1	PRODUCT SPEC 108-94694	RESTRICTED TO -											
			APPLICATION SPEC 114-94556	SIZE A3	CAGE CODE 00779										
			WEIGHT	DRAWING NO C-2337994-4	REV A										
CUSTOMER DRAWING			SCALE 3:1	SHEET 1 OF 3											



REVISIONS

P	LTR	DESCRIPTION	DATE	DWN	APVD
-	-	SEE SHEET 1	-	-	-

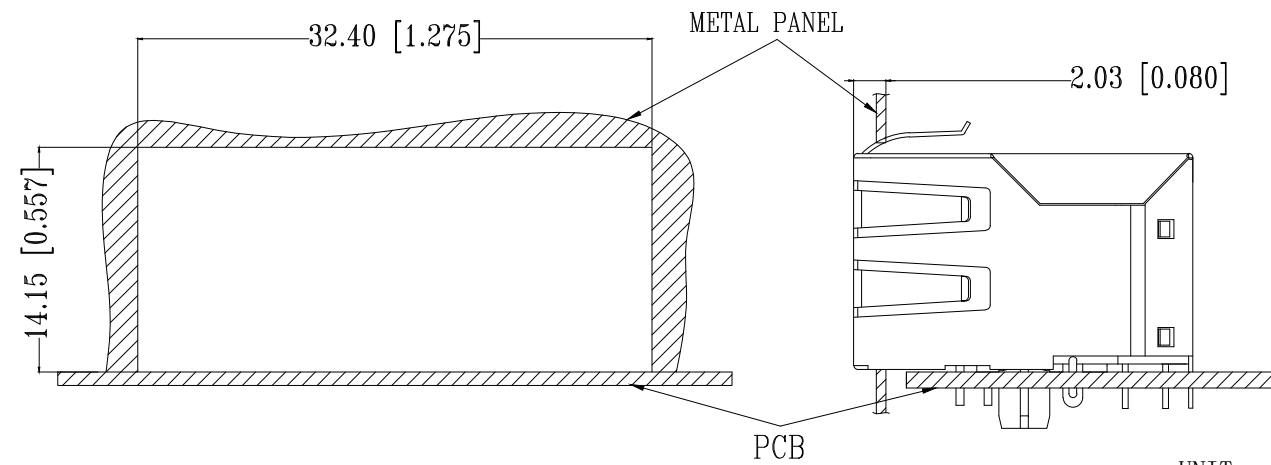
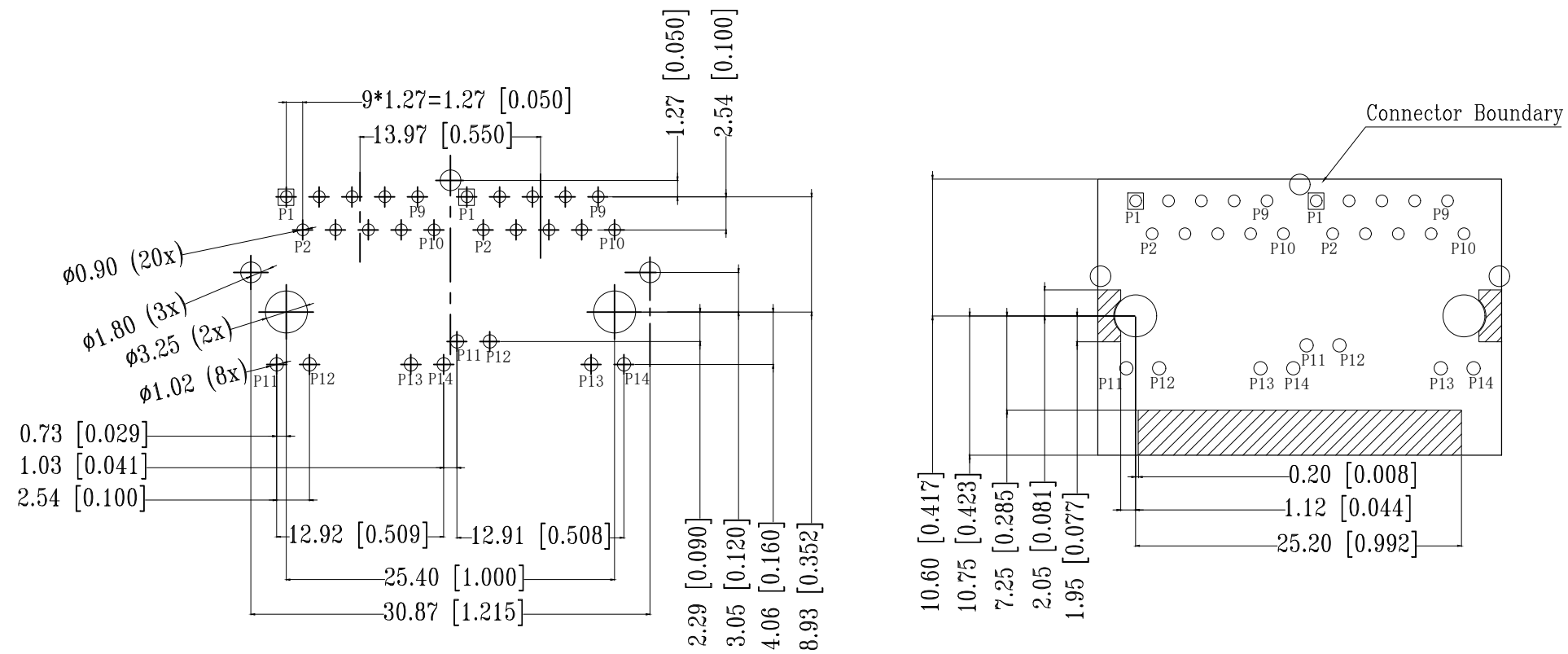
SUGGESTED PCB LAYOUT



UNIT: mm / inch
TOLERANCES: ±0.10 / 0.004

THIS DRAWING IS A CONTROLLED DOCUMENT.		DWN GANESH C M 26NOV2018	 TE Connectivity		
DIMENSIONS: mm [INCHES]		CHK O. WIBORG 26NOV2018			
TOLERANCES UNLESS OTHERWISE SPECIFIED:		APVD J. DE BRUIJN 26NOV2018	PRODUCT SPEC 108-94694		
0 PLC ± -		APPLICATION SPEC 114-94556			
1 PLC ± -		WEIGHT			
2 PLC ± -		SIZE A3			
3 PLC ± -		CAGE CODE 00779			
4 PLC ± -	DRAWING NO C-2337994-4				
ANGLES ± -	RESTRICTED TO				
MATERIAL 1	FINISH 1	SCALE 3:1			
CUSTOMER DRAWING		SHEET 2 OF 3			
		REV A			

REVISIONS					
P	LTR	DESCRIPTION	DATE	DWN	APVD
	-	SEE SHEET 1	-	-	-

ELECTRICAL CIRCUIT DIAGRAM

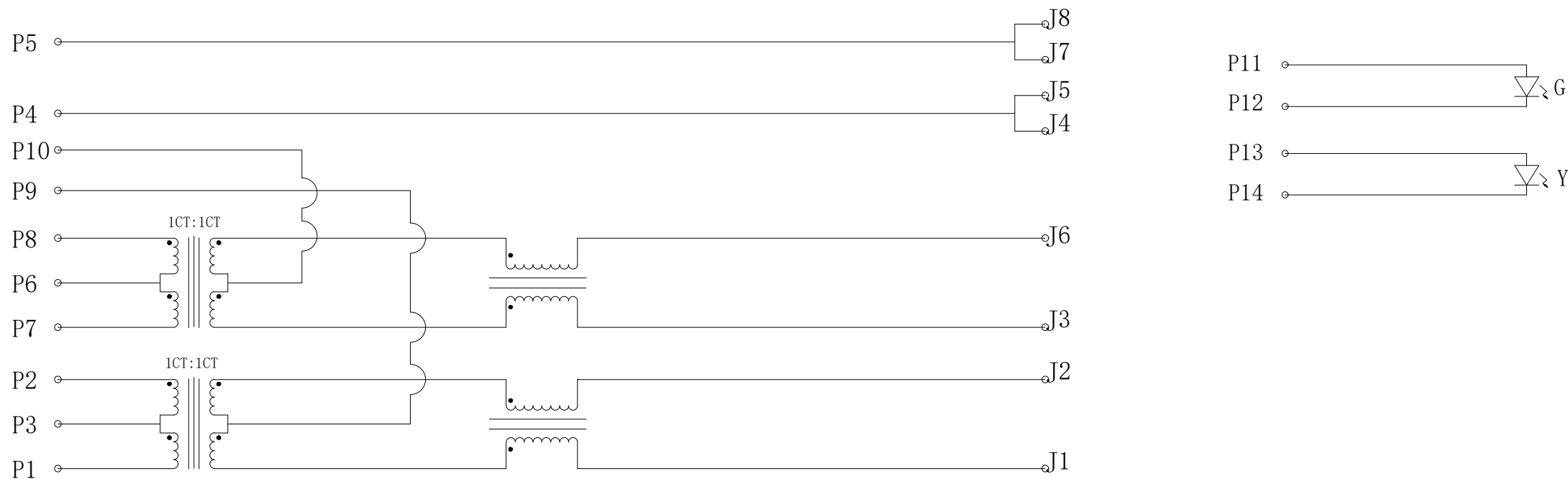

Pin	Green	Pin	Yellow
P11	+	P13	+
P12	-	P14	-

- 1.0 Turn Ratio @100kHz: (P1~P2):(J1~J2) = 1:1±2%
(P7~P8):(J3~J6) = 1:1±2%
- 2.0 Primary Inductance: 350µH MIN. @100kHz,0.1V 8mA DC BIAS
- 3.0 DC Resistance: 1.2 OHMS MAX.
- 4.0 Insertion Loss: 1-100MHz -1.2dB MAX.
- 5.0 Return Loss: 1-30MHz -16dB MIN.
30-60MHz -12dB MIN.
60-80MHz -10dB MIN.
- 6.0 CROSS TALK: 1-100MHz -27.1dB MIN.
- 7.0 COMMON TO COMMON MODE ATTENUATION: 1-100MHz -30dB MIN.
- 8.0 Isolation: PHY Side to Line Side: 500VAC
- 9.0 DC CURRENT/VOLTAGE RATING-PSE PINS: 720mA @57V(CONTINUOUS)

2337994-4
WWYY-xxxx

TE

FCC

CONTROL CODE
DATE CODE
"0213"
YY-YEAR
WW-WEEK

THIS DRAWING IS A CONTROLLED DOCUMENT.		DWN GANESH C M 26NOV2018	TE TE Connectivity		
DIMENSIONS: mm [INCHES]		CHK O. WIBORG 26NOV2018			
TOLERANCES UNLESS OTHERWISE SPECIFIED:		APVD J. DE BRUIJN 26NOV2018	NAME RJ45 JACK MAG. POE 10/100 LED 1x2		
0 PLC ± - 1 PLC ± - 2 PLC ± - 3 PLC ± - 4 PLC ± - ANGLES ± -		PRODUCT SPEC 108-94694	RESTRICTED TO		
MATERIAL 1		FINISH 1	APPLICATION SPEC 114-94556	SIZE A3	CAGE CODE 00779
			WEIGHT	DRAWING NO C-2337994-4	
CUSTOMER DRAWING			SCALE 3:1	SHEET 3 OF 3	REV A

X-ON Electronics

Largest Supplier of Electrical and Electronic Components

Click to view similar products for [Modular Connectors / Ethernet Connectors](#) category:

Click to view products by [TE Connectivity](#) manufacturer:

Other Similar products are found below :

[8949-H88/06BLKA/SN](#) [74441-0010/BKN](#) [MP1010RX-1000](#) [MP44RX-1000](#) [PHJ-4P4C-1-V-4](#) [PHP-6P6C-5](#) [GAX-3-66](#) [GAX-8-62](#) [GDCX-PA-66-50](#) [GDCX-PN-64](#) [GDCX-PN-66](#) [GDCX-PN-66-50](#) [GDLX-A-66](#) [GDLX-N-66](#) [GDLX-S-66](#) [GDLX-S-88K](#) [GDTX-S-88-50](#) [GDX-PA-1010](#) [GLX-N-1010M-BLK](#) [GLX-S-88M-BLK](#) [GMX-N-1010](#) [GMX-S-1010](#) [GMX-S-66](#) [GMX-SMT4-N-88](#) [GPX-2-64](#) [GSGX-N-2-88](#) [GSGX-N-4-88](#) [GSX-NS2-88-3.05](#) [GSX-NS2-88-3.05-50](#) [GSX-NS-88-3.05-50](#) [PT-108A-8C-UL](#) [PT-J951-8C](#) [PTS-J531-8CS-50UL](#) [1-1775629-2](#) [A-2014-0-4](#) [GWLX-S-88-GR](#) [GWLX-S9-88-YG](#) [DC-1021-8-WH-6](#) [1300530003](#) [1324640-4](#) [RJ11FTVC2G](#) [RJ11FTVC2N](#) [RJFTVX2SA1G](#) [132764-001](#) [1413235](#) [MP88X-1000](#) [MPS88RX-5000](#) [E5288-S000K3-L](#) [E5908-15A242-L](#) [155302-001](#)