

THIS DRAWING IS UNPUBLISHED.

RELEASED FOR PUBLICATION

© COPYRIGHT -

ALL RIGHTS RESERVED.

LOC H DIST -

REVISIONS

P	LTR	DESCRIPTION	DATE	DWN	APVD
H3		APPLICATION SPECIFICATION NUMBER ADDED	24JUL2013	KJK	RP
H4		BLISTER MATERIAL CHANGE FOR 16POS	05MAY2015	NV	PS

REFERENCE MATING INTERFACE PATTERN:
1,27 STAGGERED PITCH x 1,5 ROW-DISTANCE.

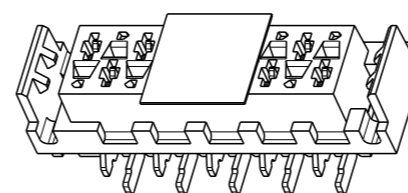
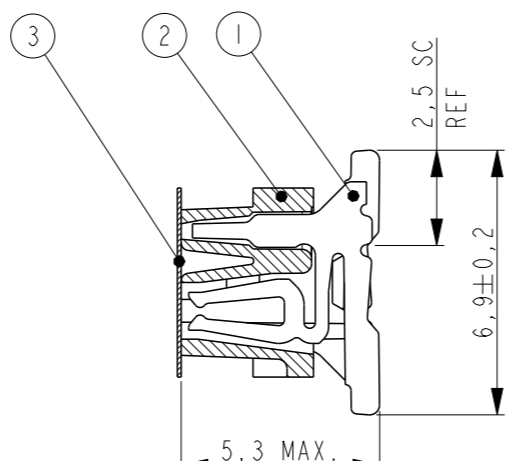
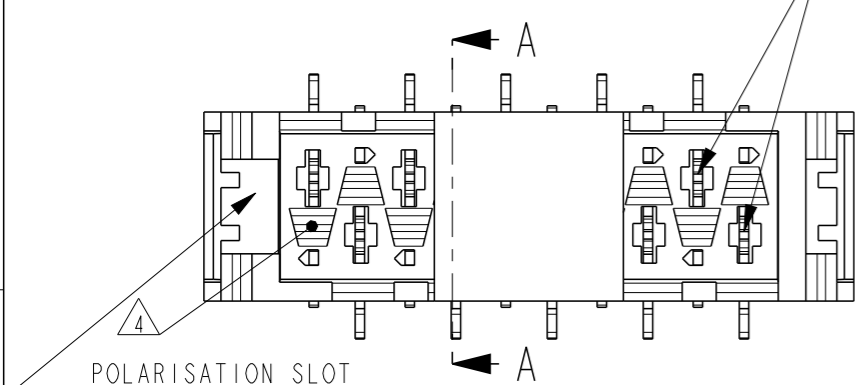

SCALE 3:1

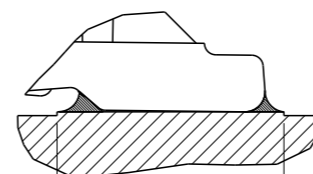

SOLDER DETAIL
SCALE 10:1

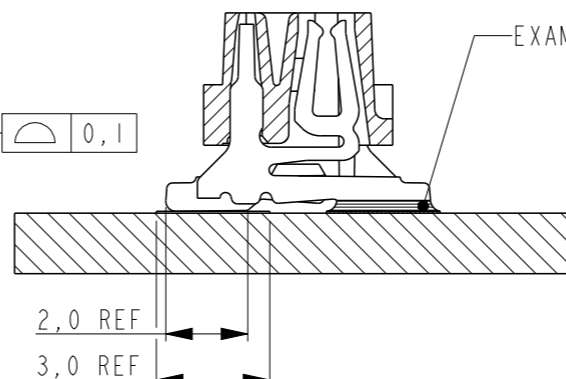

△ PART NUMBER VAC. TAPE.	PART NUMBER ³	PART REV	NR. OF POS. "n"	"A"	"B" MAX.
7-338069-4	0-338069-4	K	4	3,81	9,7
7-338069-6	0-338069-6	K	6	6,35	12,2
7-338069-8	0-338069-8	K	8	8,89	14,7
8-338069-0	1-338069-0	K	10	11,43	17,3
8-338069-2	1-338069-2	K	12	13,97	19,8
8-338069-4	1-338069-4	K	14	16,51	22,4
8-338069-6	1-338069-6	L	16	19,05	24,9
8-338069-8	1-338069-8	K	18	21,59	27,4
9-338069-0	2-338069-0	K	20	24,13	30,0
9-338069-4	2-338069-4	K	24	29,21	35,0

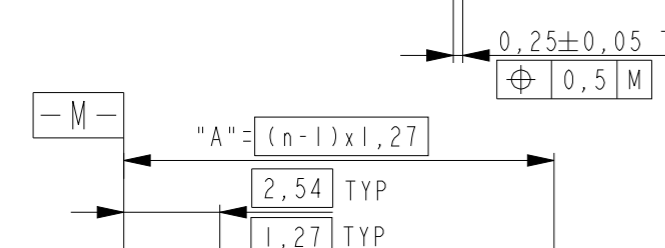
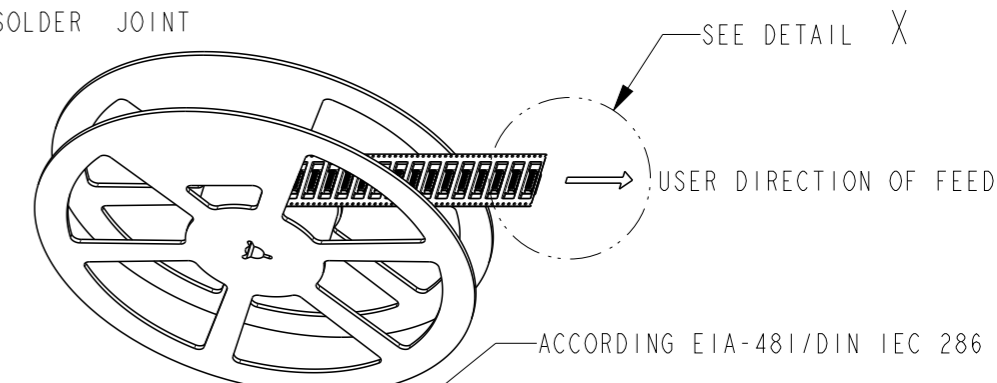
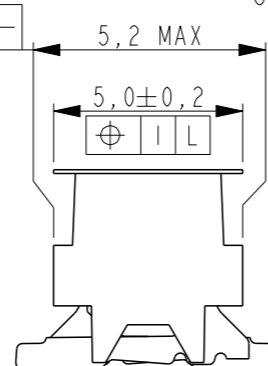
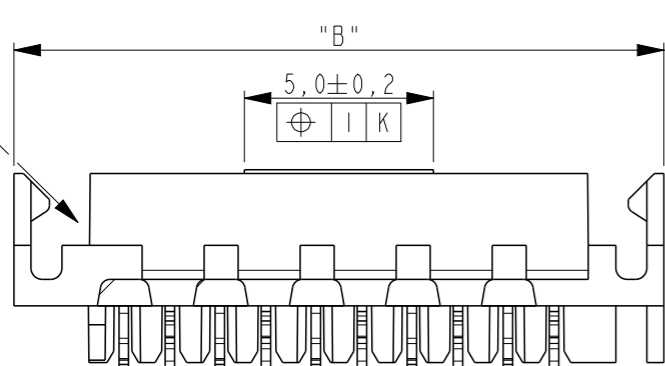

NOTES:

- △ TAPE FOR VACUUM P&P ONLY FOR DASH NUMBERS 7- /8- /9-
- 2 FOR PACKAGING SEE SHEET 2 AND 3
- △ WITHOUT VACUUM TAPE.
- △ CORING-OUTS FOR MANUFACTURING PURPOSE ONLY. SHAPE MAY VARY, BUT IS NOT FUNCTIONAL FOR THE APPLICATION.
- 5 SHOWN IS A 10 POSITION CONNECTOR.

DETAIL X
SCALE 1:1

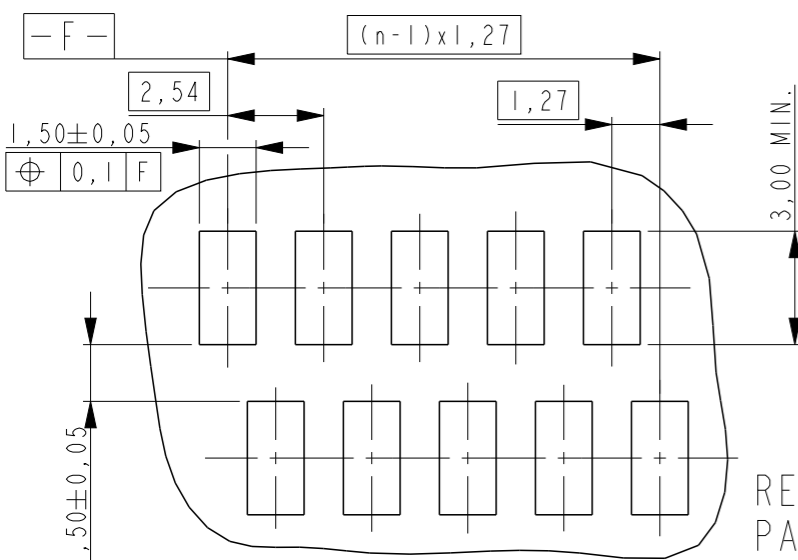
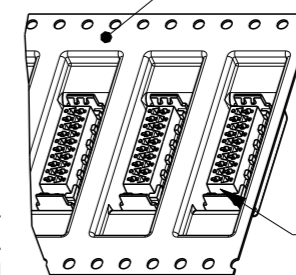

Item no.	Description	Material	Finish
3	PICK & PLACE TAPE	KAPTON	AMBER TRANSPARENT
2	FEMALE HOUSING	POLYAMIDE 4/6,GF	RED
1	FEMALE CONTACT	PHOSPHOR BRONZE	TIN OVER NICKEL

THIS DRAWING IS A CONTROLLED DOCUMENT.	
DIMENSIONS: mm	TOLERANCES UNLESS OTHERWISE SPECIFIED:
0 PLC ±-	1 PLC ±-
1 PLC ±-	2 PLC ±-
2 PLC ±-	3 PLC ±-
3 PLC ±-	4 PLC ±-
4 PLC ±-	ANGLES ±-
MATERIAL SEE TABLE	FINISH SEE TABLE

DWN M. Gosselink IIDE001

CHK -

APVD -

PRODUCT SPEC 108-19052

APPLICATION SPEC 114-13318

WEIGHT -

CUSTOMER DRAWING

STE TE Connectivity

CONNECTOR, FEMALE-ON-BOARD TOP-ENTRY, SMD, WITH LATCHES, Micro-MaTch

SIZE A3	CAGE CODE 00779	DRAWING NO C-338069	RESTRICTED TO -
---------	-----------------	---------------------	-----------------

SCALE 5:1 SHEET 1 OF 3 REV H4

THIS DRAWING IS UNPUBLISHED.

RELEASED FOR PUBLICATION

© COPYRIGHT -

ALL RIGHTS RESERVED.

LOC H DIST -

REVISIONS

P	LTR	DESCRIPTION	DATE	DWN	APVD
-	-	SEE SHEET 1	-	-	-

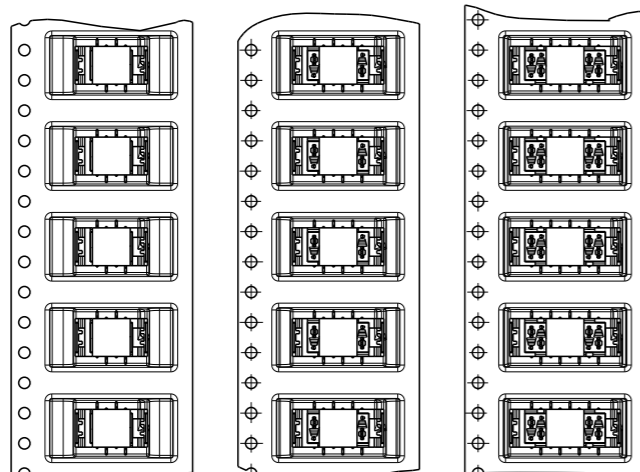

7-338069-4 7-338069-6 7-338069-8

4 POSITIONS 6 POSITIONS 8 POSITIONS

338069-4 338069-6 338069-8

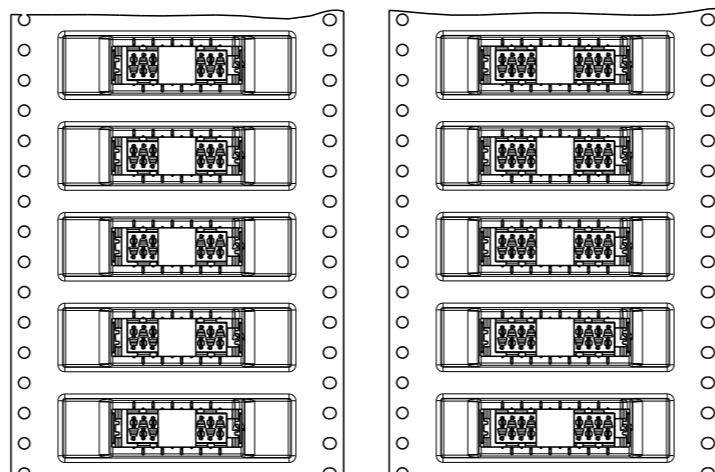
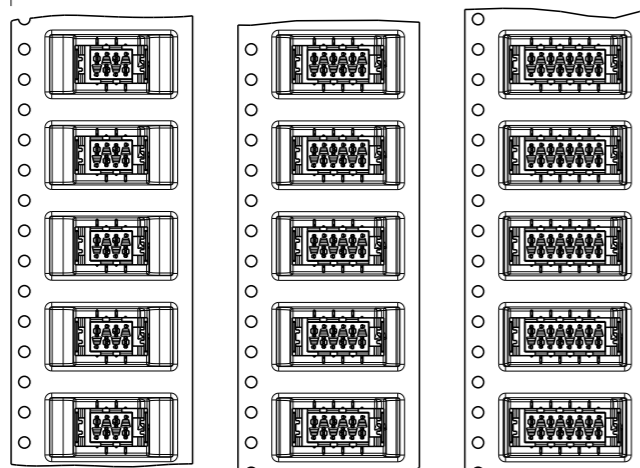

8-338069-0 8-338069-2

10 POSITIONS 12 POSITIONS

1-338069-0 1-338069-2

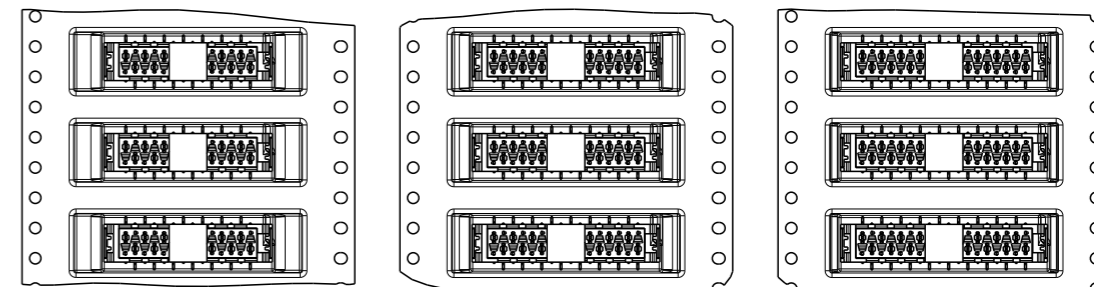
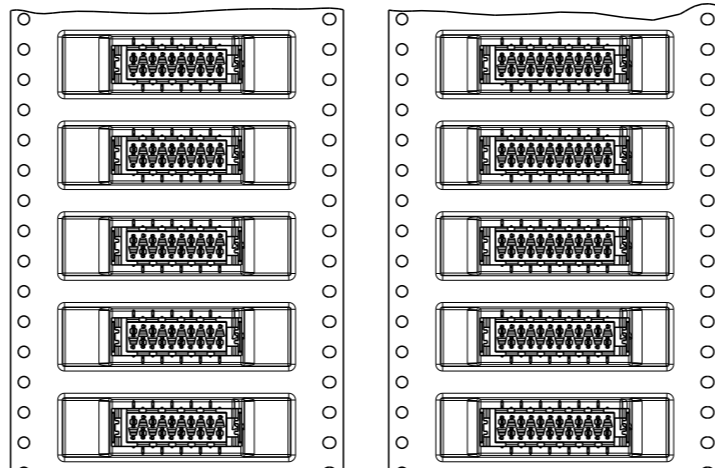

8-338069-4 8-338069-6 8-338069-8

14 POSITIONS 16 POSITIONS 18 POSITIONS

1-338069-4 1-338069-6 1-338069-8

24mm wide tape 24mm wide tape 24mm wide tape

44mm wide tape 44mm wide tape 44mm wide tape 44mm wide tape 44mm wide tape

THIS DRAWING IS A CONTROLLED DOCUMENT.

DWN M. Gosselink IDECOI

CHK -

APVD -

PRODUCT SPEC 108-19052

APPLICATION SPEC 114-13318

WEIGHT -

CUSTOMER DRAWING



NAME CONNECTOR, FEMALE-ON-BOARD TOP-ENTRY, SMD, WITH LATCHES, Micro-MaTch

SIZE A3 CAGE CODE 00779 DRAWING NO C-338069 RESTRICTED TO -

SCALE 5:1 SHEET 2 OF 3 REV H4

DIMENSIONS: mm

TOLERANCES UNLESS OTHERWISE SPECIFIED:

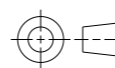

- 0 PLC ±-
- 1 PLC ±-
- 2 PLC ±-
- 3 PLC ±-
- 4 PLC ±-
- ANGLES ±-
- FINISH -

MATERIAL -

THIS DRAWING IS UNPUBLISHED.

RELEASED FOR PUBLICATION

© COPYRIGHT -

ALL RIGHTS RESERVED.

LOC H DIST -

REVISIONS

P	LTR	DESCRIPTION	DATE	DWN	APVD
-	-	SEE SHEET 1	-	-	-

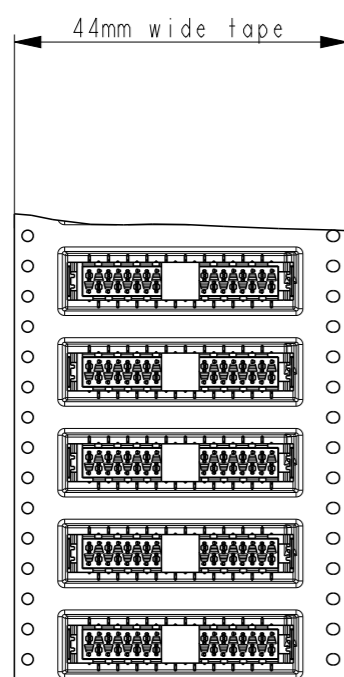

9-338069-0
20 POSITIONS
2-338069-0

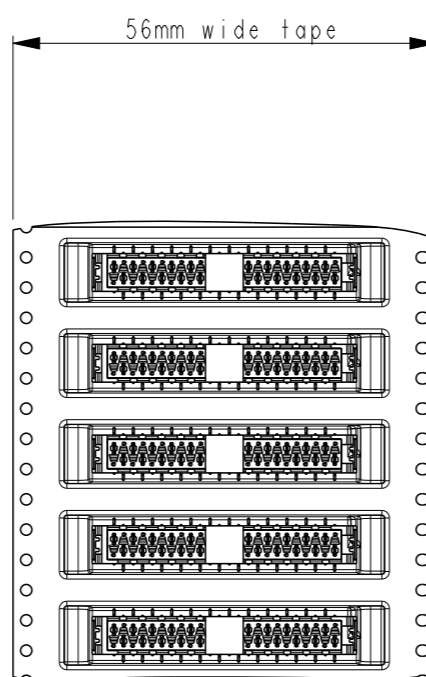

9-338069-4
24 POSITIONS
2-338069-4

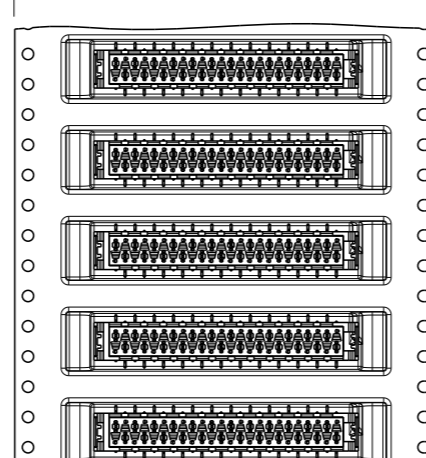
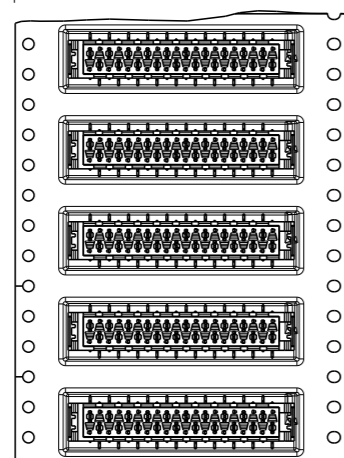

THIS DRAWING IS A CONTROLLED DOCUMENT.

DIMENSIONS:
mm

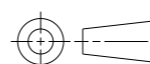

TOLERANCES UNLESS OTHERWISE SPECIFIED:

- 0 PLC ±-
- 1 PLC ±-
- 2 PLC ±-
- 3 PLC ±-
- 4 PLC ±-
- ANGLES ±-
- FINISH -

MATERIAL -

DWN M.Gosselink IDECO1

CHK -

APVD -

PRODUCT SPEC

108-19052

APPLICATION SPEC

114-13318

WEIGHT -

CUSTOMER DRAWING



TE Connectivity

NAME
CONNECTOR,
FEMALE-ON-BOARD TOP-ENTRY,
SMD, WITH LATCHES, Micro-MaTch

SIZE CAGE CODE DRAWING NO RESTRICTED TO

A3 00779 C-338069

SCALE 5:1 SHEET 3 OF 3 REV H4

X-ON Electronics

Largest Supplier of Electrical and Electronic Components

Click to view similar products for [Headers & Wire Housings](#) category:

Click to view products by [TE Connectivity](#) manufacturer:

Other Similar products are found below :

[892-18-020-10-001101](#) [58102-G61-06LF](#) [582553-1](#) [0009485154](#) [009176003701906](#) [0050291907](#) [LY20-4P-DT1-P1E-BR](#) [02.125.8002.8](#)
[609-3404](#) [61062-3](#) [61082-181009](#) [622-3653LF](#) [63453-116](#) [636-1030](#) [636-1427](#) [636-3427](#) [636-4007](#) [641938-9](#) [641991-4](#) [644827-2](#) [65817-010LF](#) [65817-015LF](#) [65863-015LF](#) [66207-023LF](#) [67095-007LF](#) [67601157](#) [68645-018](#) [68648-049](#) [70.362.1628.0](#) [70-4210](#) [70-4226B](#) [70-4853B](#) [707-5020](#) [707-5028](#) [71.350.2428.0](#) [71918-208LF](#) [71961-016LF](#) [733-134](#) [733-162](#) [754199-000](#) [760-3052](#) [787-8014-00](#) [79531-3000](#)
[FCN-360C032-B](#) [FCN-367T-T012/H](#) [FCN-723D010/2](#) [80.063.4001.1](#) [800-90-001-10-001000](#) [800-90-010-10-002000](#) [801-43-002-10-013000](#)