

234914-1 ✓ ACTIVE

Power Versa-Lock | Power Double Lock, Power Versa-Lock 5.0

TE Internal #: 234914-1

Power Double Lock, Insertion & Extraction Tools, Contact Extraction, Contact-to-Housing

[View on TE.com >](#)



Application Tooling > Insertion & Extraction Tools



Insertion & Extraction Tool Type: **Contact Extraction**

Insertion & Extraction Tool Application: **Contact-to-Housing**

Features

Product Type Features

Insertion & Extraction Tool Type	Contact Extraction
Insertion & Extraction Tool Application	Contact-to-Housing

Product Compliance

[For compliance documentation, visit the product page on TE.com>](#)

EU RoHS Directive 2011/65/EU	Compliant
EU ELV Directive 2000/53/EC	Out of Scope
China RoHS 2 Directive MIIT Order No 32, 2016	No Restricted Materials Above Threshold
EU REACH Regulation (EC) No. 1907/2006	Current ECHA Candidate List: JAN 2021 (211) Candidate List Declared Against: JAN 2021 (211) Does not contain REACH SVHC
Halogen Content	Not Yet Reviewed for halogen content
Solder Process Capability	Not applicable for solder process capability

Product Compliance Disclaimer

This information is provided based on reasonable inquiry of our suppliers and represents our current actual knowledge based on the information they provided. This information is subject to change. The part numbers that TE has identified as EU RoHS compliant have a maximum concentration of 0.1% by weight in homogenous materials for lead, hexavalent chromium, mercury, PBB, PBDE, DBP, BBP, DEHP, DIBP, and 0.01% for cadmium, or qualify for an exemption to these limits as defined in the Annexes of Directive 2011/65/EU (RoHS2). Finished electrical and electronic equipment products will be CE marked as required by Directive 2011/65/EU. Components may not be CE marked. Additionally, the part numbers that TE has identified as EU ELV compliant have a maximum concentration of 0.1% by weight in homogenous materials for lead, hexavalent chromium, and mercury, and 0.01% for cadmium, or qualify for an exemption to these limits as defined in the Annexes of Directive 2000/53/EC (ELV). Regarding the REACH Regulation, the information TE provides

on SVHC in articles for this part number is based on the latest European Chemicals Agency (ECHA) 'Guidance on requirements for substances in articles' posted at this URL: <https://echa.europa.eu/guidance-documents/guidance-on-reach>

Compatible Parts



TE Part # CAT-P87024-T111
Power Double Lock Tab



TE Part # 2329906-1
Power Versa-Lock TAB, 18-20, 2X22 AWG



TE Part # 2329907-1
Power Versa-Lock SEAL TAB, 14-16 AWG



TE Part # 2329908-1
Power Versa-Lock SEAL TAB, 18-20 AWG



TE Part # 2329909-1
Power Versa-Lock TAB, 22-26 AWG



TE Part # 1-177917-2
AMP POWER DBL LOCK TAB(L)



TE Part # 177917-2
AMP POWER DBL BLOCK TAB(L)



TE Part # 179595-2
AMP POWER D/LOCK TAB CONT,L/P



TE Part # 2329906-2
PWR VERSA-LOCK TAB HC, 18-20, 2X22 AWG



TE Part # 2329907-2
PWR VERSA-LOCK SEAL TAB HC, 14-16 AWG



TE Part # 2329908-2
PWR VERSA-LOCK SEAL TAB HC, 18-20AWG

Also in the Series | Power Double Lock



Connector Contacts(1)



Insertion & Extraction Tools(2)



Power Contacts(18)



Rectangular Connector Locking(14)



Rectangular Power Connectors(277)

Also in the Series | Power Versa-Lock 5.0



Insertion & Extraction Tools(2)

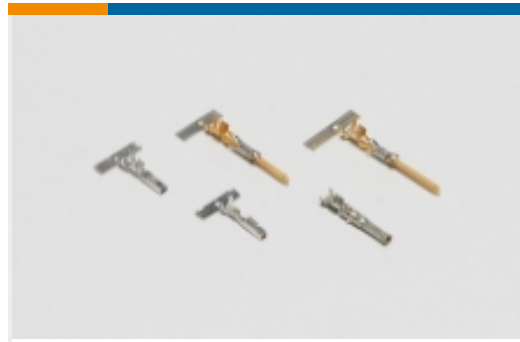

Power Contacts(8)



Rectangular Caps & Covers(3)



Rectangular Connector Locking(1)



Rectangular Connector Seals(6)



Rectangular Power Connectors(33)

Customers Also Bought



TE Part #175194-2
DYNAMIC D-3 REC CONT/S AU 0.38

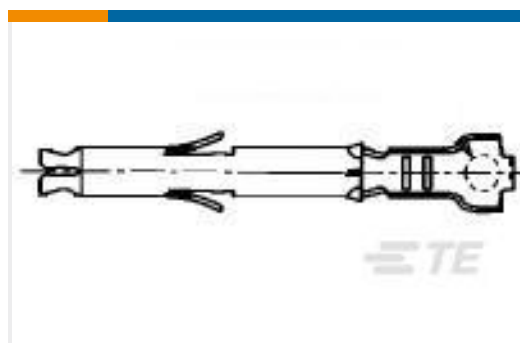

TE Part #170366-1
MINI UNIVERSAL M-N-L SOCKET LP

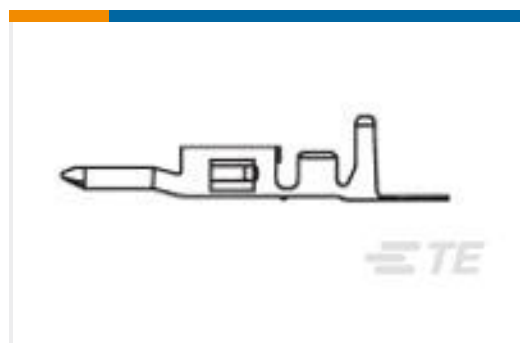

TE Part #1586054-1
VAL-U-LOK PIN BR SN 16AWG



TE Part #1318095-1
DYNAMIC D-3500 REC HSG 6P



TE Part #152753-000
DWP-125-1/8-0-2IN

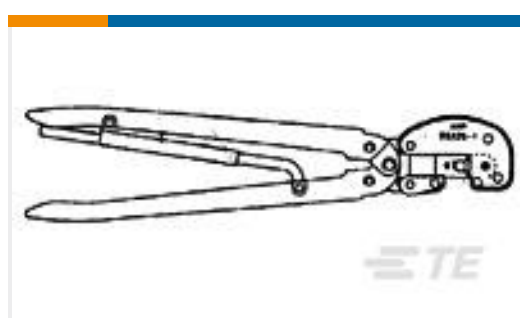

TE Part #1366044-1
HHHT DYNAMIC D-5 L 8 ASSY



TE Part #1-2217206-1
Blade, Slug

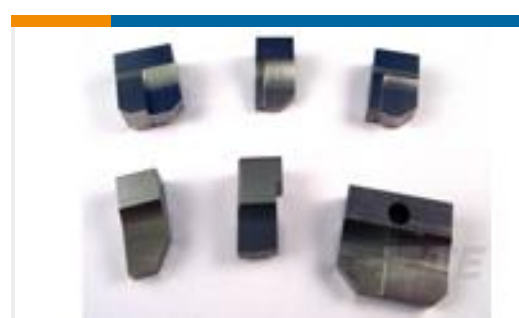

TE Part #1-454766-7
ANVIL, INSULATION

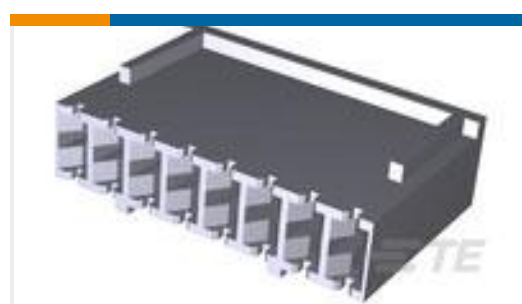

TE Part #1241980-8
SPECIAL STANDARD TIMER
HOUSING 8POS

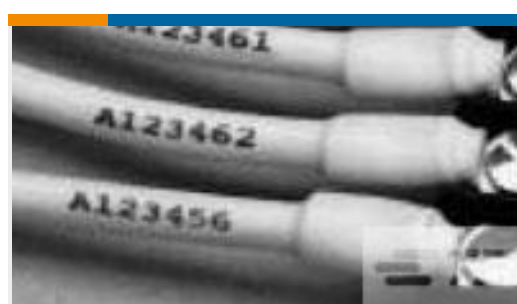

TE Part #CZ8951-000
RNF-100-1-BK-1.25IN

Documents

Product Drawings

[EXT TOOL FOR POWER DBL LOK TAB](#)

Japanese

Datasheets & Catalog Pages

[Crimp Term Whitepaper-Use the Right Tool 1-1773953-1](#)

English

[CRIMPING WHERE FORM MEETS FUNCTION](#)

English

[Insertion-Extraction-Tool-2345721-1](#)

English

Product Specifications

[The Extraction Tool for AMP Power Double Lock connectors](#)

Japanese

X-ON Electronics

Largest Supplier of Electrical and Electronic Components

Click to view similar products for [Extraction, Removal & Insertion Tools](#) category:

Click to view products by [TE Connectivity](#) manufacturer:

Other Similar products are found below :

[M8196914-08](#) [768211-2](#) [809-131](#) [844751-2](#) [8-59558-2](#) [91018-1](#) [12014013](#) [12093647](#) [1-21048-0](#) [R282867020](#) [12093078](#) [1-21048-6](#)
[12121897](#) [DCF.91.405.5LT](#) [1322](#) [15314260](#) [15350698](#) [15350707](#) [15430130](#) [1579018-4](#) [1643916-1](#) [1-679532-0](#) [1976593-3](#) [OUTEXT-0321](#)
[2-1579008-3](#) [2-1579008-4](#) [229694-7](#) [231106-1](#) [241469](#) [91040-3](#) [91040-7](#) [965004-000](#) [965069-000](#) [1738219-1](#) [ET-JL05-16](#) [FG 0300 146](#)
[3000](#) [FIT-6](#) [210S048](#) [2-1579007-9](#) [231879-1](#) [312138-3](#) [RJ11FODE](#) [356-162](#) [M8196914-10](#) [4-1579018-0](#) [430395-001](#) [483249-1](#) [5-](#)
[1579007-2](#) [5-1579007-9](#) [BPR10](#)