

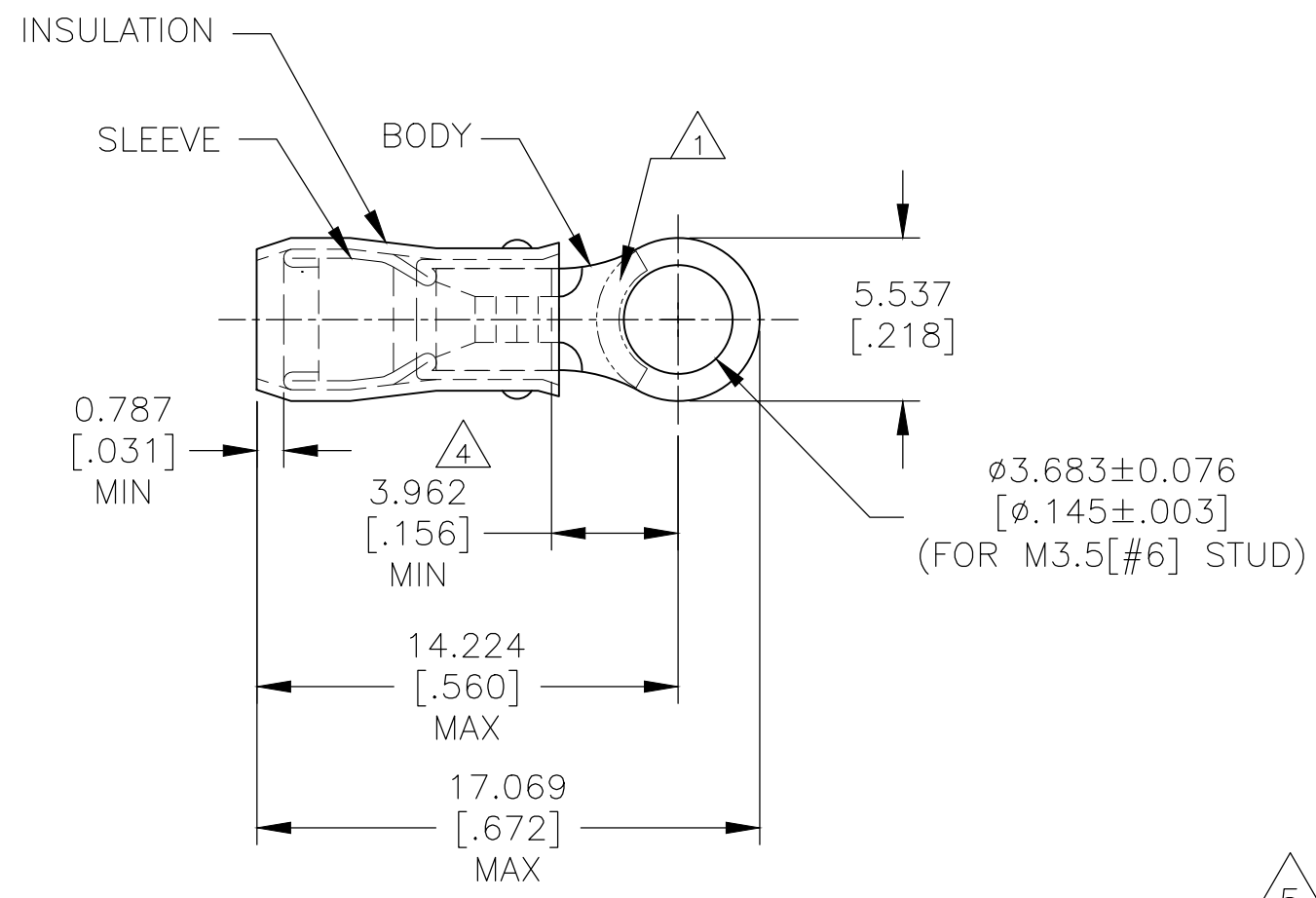











THIS DRAWING IS UNPUBLISHED. RELEASED FOR PUBLICATION
 © COPYRIGHT - By - ALL RIGHTS RESERVED.

REVISIONS					
P	LTR	DESCRIPTION	DATE	DWN	APVD
	V1	REVISED PER ECO-17-007400	15DEC2017	RS	DR
	V2	REVISED PER ECO-19-007720	21MAY2020	KR	DR

AMP WIRE RANGE	 E13288 Listed	 LR7189 Certified
22-16 AWG SOLID OR STRANDED	22-16 AWG STRANDED	22-16 AWG SOLID OR STRANDED



-  STAMP AMP 22-18* APPROX AS SHOWN
22-16 TERMINALS ARE STAMPED 22-18 IN
ACCORDANCE WITH MILITARY SPEC SAE AS7928
COMMERCIAL WIRE RANGE IS 22-16.
-  WIRE INSULATION : $\phi 2.032-3.175[\phi 0.080-.125]$
-  BODY MATERIAL THK: $0.787 \pm 0.051[.031 \pm .002]$
-  APPLIES FROM EDGE OF METAL WIRE BARREL
TO CENTER OF STUD HOLE.
-  UL LISTED
-  CSA CERTIFIED

 	-	100	LOOSE PIECE, BOX	8-36149-1
 	MS25036-101 CLASS 2	5000	ON TAPE, REEL	2-36149-2
 	MS25036-101 CLASS 1 & 2	1000	LOOSE PIECE	36149
	MILITARY P/N AND CLASS	QUANTITY	PACKAGE TYPE	PART NO

AMP INCORPORATED
CUSTOMER SERVICE SYSTEMS

FOR ADDITIONAL
 PRODUCT INFORMATION OR
 COPIES OF DRAWINGS
 AND TECHNICAL DOCUMENTS
 PRODUCT INFORMATION CENTER
 1-800-522-6752

FOR APPLICATION
 TOOLING ASSISTANCE CENTER
 TOOLING INFORMATION
 1-800-722-1111

FOR ORDER ENTRY
 1-800-526-5142

MAX RECOMMENDED OPERATING
 TEMPERATURE:
 105°C[221°F] MAX

VOLTAGE RATING:
 300 V MAX

CIRCULAR MIL AREA:
 0.26-1.65mm²[509-3,260] CIR MILS
 SOLID OR STRANDED

THIS DRAWING IS A CONTROLLED DOCUMENT.

DIMENSIONS:
 mm[INCHES]

TOLERANCES UNLESS
 OTHERWISE SPECIFIED:

0 PLC ± -
 1 PLC ± -
 2 PLC ± -
 3 PLC ± 0.127[.005]
 4 PLC ± -
 ANGLES ± -

MATERIAL
 BODY & SLEEVE:
 COPPER PER ASTM B-152
 INSULATION: NYLON

FINISH
 BODY & SLEEVE:
 TIN PLATE PER ASTM B545
 INSULATION: COLOR-RED

DWN DK SCHRUM 9/8/93
 CHK RE HERSEY 9/8/93
 APVD ML ELLIS 9/8/93

STE TE Connectivity

NAME
 TERMINAL, RING TONGUE,
 PIDG™, WIRE SIZE, 22-16 AWG

PRODUCT SPEC
 UL 486 A-B 

APPLICATION SPEC
 114-2157

WEIGHT -

SIZE A3 CAGE CODE 00779 DRAWING NO C-36149 RESTRICTED TO -

CUSTOMER DRAWING SCALE NTS SHEET 1 OF 2 REV V2

THIS DRAWING IS UNPUBLISHED. RELEASED FOR PUBLICATION
 © COPYRIGHT - By - ALL RIGHTS RESERVED.

REVISIONS					
P	LTR	DESCRIPTION	DATE	DWN	APVD
-	-	SEE SHEET 1	-	-	-

AMP WIRE RANGE	△5 LR 7189 Certified
SEE TABLE STRANDED	WIRE SIZE PER TABLE STRANDED

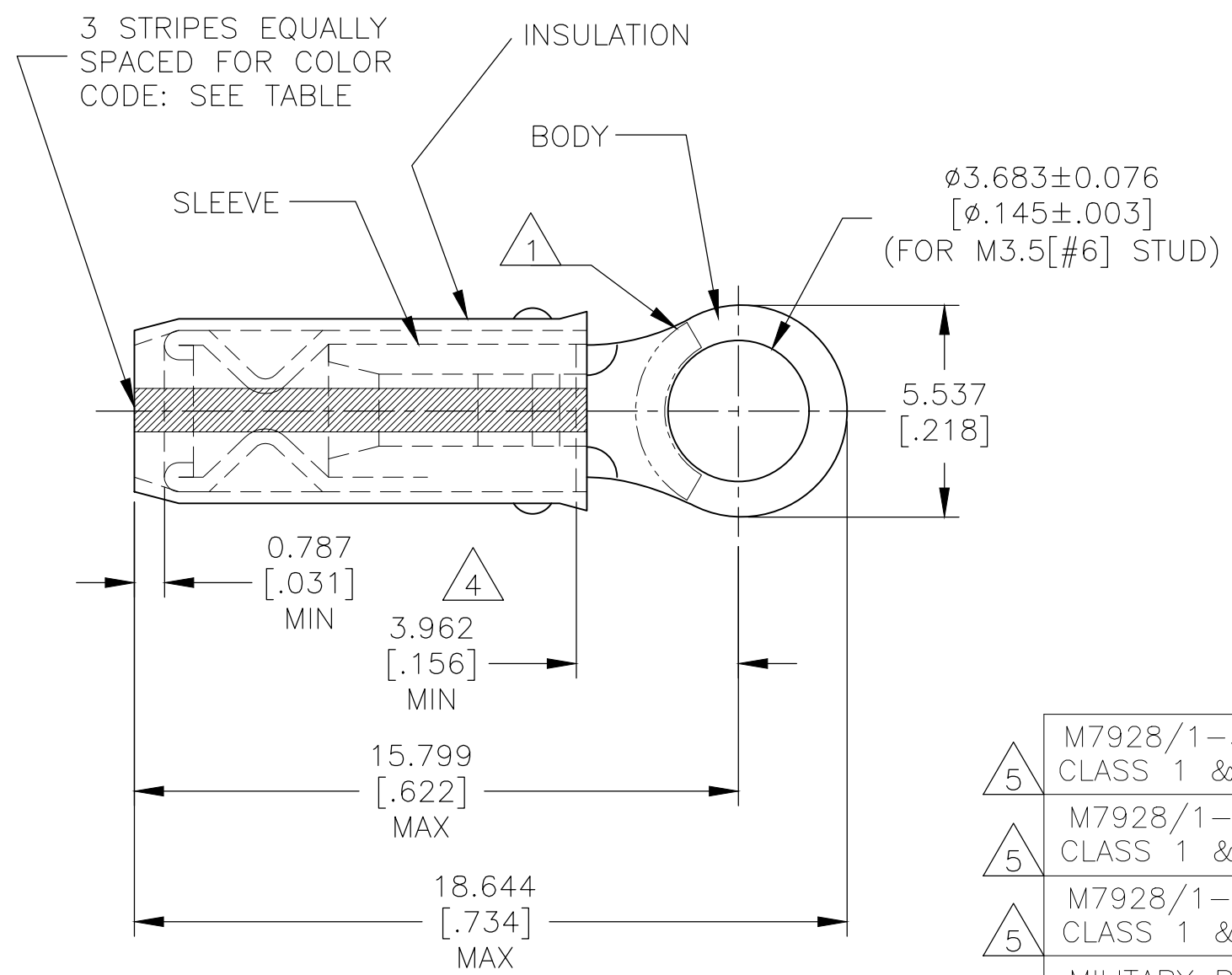

- △1** STAMP AMP APPROX AS SHOWN SEE TABLE BELOW.
- 2** WIRE INSULATION : $\phi 0.965-2.794[\phi 0.038-.110]$ FOR 22 AWG
 $\phi 1.168-2.794[\phi 0.046-.110]$ FOR 20 AWG
 $\phi 1.422-2.794[\phi 0.056-.110]$ FOR 18 AWG.
- 3** BODY MATERIAL THK: $0.787\pm 0.051[.031\pm .002]$
- △4** APPLIES FROM EDGE OF METAL WIRE BARREL TO CENTER OF STUD HOLE.
- △5** CSA CERTIFIED

△5	M7928/1-30 CLASS 1 & 2	WHITE	18*	18	1000	LOOSE PIECE	2-36149-5
△5	M7928/1-21 CLASS 1 & 2	RED	20*	20	1000	LOOSE PIECE	2-36149-4
△5	M7928/1-12 CLASS 1 & 2	GREEN	22*	22	1000	LOOSE PIECE	2-36149-3
	MILITARY P/N AND CLASS	STRIPE COLOR	△ STAMPING	WIRE SIZE	QUANTITY	PACKAGE TYPE	PART NO

AMP INCORPORATED CUSTOMER SERVICE SYSTEMS		MAX RECOMMENDED OPERATING TEMPERATURE: 105°C[221°F] MAX	THIS DRAWING IS A CONTROLLED DOCUMENT.		DWN DK SCHRUM 9/8/93	STE TE Connectivity			
FOR ADDITIONAL PRODUCT INFORMATION OR COPIES OF DRAWINGS AND TECHNICAL DOCUMENTS	PRODUCT INFORMATION CENTER 1-800-522-6752	VOLTAGE RATING: 300 V MAX	DIMENSIONS: mm[NCHES]	TOLERANCES UNLESS OTHERWISE SPECIFIED:	CHK RE HERSEY 9/8/93				NAME
FOR APPLICATION TOOLING INFORMATION	TOOLING ASSISTANCE CENTER 1-800-722-1111	WIRE RANGE: CIRC MIL AREA: 22 0.38mm ² [754] 20 0.60mm ² [1,186] 18 0.96mm ² [1,900] STRANDED		0 PLC ± - 1 PLC ± - 2 PLC ± - 3 PLC ± 0.127[.005] 4 PLC ± - ANGLES ± -	APVD ML ELLIS 9/8/93	TERMINAL, RING TONGUE, I.R., PIDG™ WIRE SIZE, 22, 20 & 18 AWG			
FOR ORDER ENTRY	1-800-526-5142		MATERIAL BODY & SLEEVE: COPPER PER ASTM B-152 INSULATION: NYLON	FINISH BODY & SLEEVE: TIN PLATE PER ASTM B545 INSULATION: COLOR-RED	PRODUCT SPEC -	SIZE	CAGE CODE	DRAWING NO	RESTRICTED TO
CUSTOMER DRAWING					114-2157	A3	00779	C-36149	-
					WEIGHT	SCALE		SHEET	REV
					-	NTS		2 OF 2	V2

X-ON Electronics

Largest Supplier of Electrical and Electronic Components

Click to view similar products for [Terminals](#) category:

Click to view products by [TE Connectivity](#) manufacturer:

Other Similar products are found below :

[00-054007-01074-6](#) [00-054007-70206-1](#) [00-054007-70210-8](#) [00-054007-70217-7](#) [00-054007-70226-9](#) [00-054007-70228-3](#) [00-054007-70248-1](#) [00-054007-70256-6](#) [00-054007-70301-3](#) [00-054007-70316-7](#) [00-054007-49560-4](#) [00-054007-70209-2](#) [00-054007-70225-2](#) [00-054007-70227-6](#) [00-054007-70231-3](#) [00-054007-70241-2](#) [00-054007-70242-9](#) [00-054007-70244-3](#) [00-054007-70246-7](#) [00-054007-70263-4](#) [00-054007-70288-7](#) [00-054007-70290-0](#) [00-054007-70300-6](#) [00-054007-70304-4](#) [01-2065-1-0216](#) [01-2900-1-04412](#) [00581P0075](#) [600TS-10](#) [60205-1](#) [604200-1](#) [605601-1](#) [60598-1-CUT-TAPE](#) [61314-6-C](#) [61810-3](#) [61-S](#) [61-SN](#) [626-0194](#) [62-NBM-A](#) [62-SN](#) [62-SP](#) [63-S](#) [640179-1](#) [M55155/059I03](#) [M55155/079C01](#) [M55155/099H02](#) [M55155/109H01](#) [M55155/109H02](#) [M55155/12XH05](#) [M55155/16XH02](#) [M55155/29-5S](#)