

| REVISIONS | | | | | |
|-----------|-----|-------------|-----------|-----|------|
| P | LTR | DESCRIPTION | DATE | DWN | APVD |
| | A1 | REVISED | 08SEP2020 | J.J | W.H |

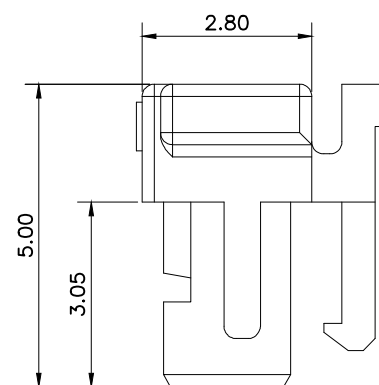
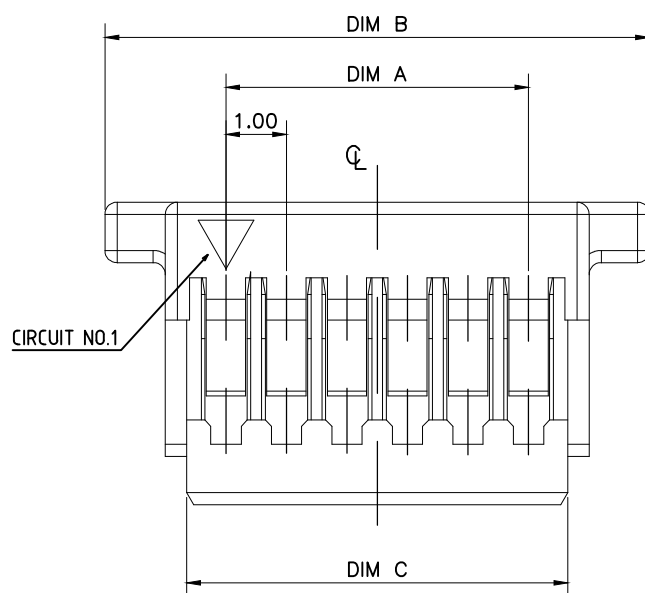
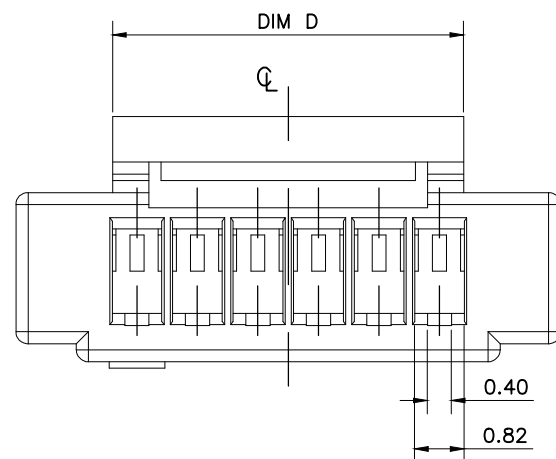

- NOTES:
 1. MATERIAL: HALOGEN FREE PLASTIC, UL94V-0.
 2. CABLE CONTACT: 2367199-1

| | | | | | | |
|-------|-------|-------|-------|-------------|-------------|-------------|
| 5.8 | 15.4 | 18.0 | 14.0 | 15 | 3-2367198-5 | 1-2367198-5 |
| | 14.4 | 17.0 | 13.0 | 14 | 3-2367198-4 | 1-2367198-4 |
| | 13.4 | 16.0 | 12.0 | 13 | 3-2367198-3 | 1-2367198-3 |
| | 12.4 | 15.0 | 11.0 | 12 | 3-2367198-2 | 1-2367198-2 |
| | 11.4 | 14.0 | 10.0 | 11 | 3-2367198-1 | 1-2367198-1 |
| | 10.4 | 13.0 | 9.0 | 10 | 3-2367198-0 | 1-2367198-0 |
| | 9.4 | 12.0 | 8.0 | 9 | 2-2367198-9 | 2367198-9 |
| | 8.4 | 11.0 | 7.0 | 8 | 2-2367198-8 | 2367198-8 |
| | 7.4 | 10.0 | 6.0 | 7 | 2-2367198-7 | 2367198-7 |
| 6.4 | 9.0 | 5.0 | 6 | 2-2367198-6 | 2367198-6 | |
| 4.8 | 5.4 | 8.0 | 4.0 | 5 | 2-2367198-5 | 2367198-5 |
| 3.0 | 4.4 | 7.0 | 3.0 | 4 | 2-2367198-4 | 2367198-4 |
| 3.0 | 3.4 | 6.0 | 2.0 | 3 | 2-2367198-3 | 2367198-3 |
| DIM.D | DIM.C | DIM,B | DIM.A | POS.NO | COLOR | |
| | | | | | P/N | |

| | | | | | | |
|---|--|--------------------------------|------------------------------------|-----------------|--------------------|-------------------------|
| THIS DRAWING IS A CONTROLLED DOCUMENT. | | DWN Tommy Qian 18DEC2019 | TE Connectivity | | | |
| DIMENSIONS: mm | | CHK Wenke He | | | | NAME |
| TOLERANCES UNLESS OTHERWISE SPECIFIED: | | APVD Wenke He | 1.0P WT B CABLE HOUSING WITH LATCH | | | |
| 0 PLC ± 0.5 1 PLC ± 0.35 2 PLC ± 0.25 3 PLC ± 0.15 4 PLC ± - ANGLES ± 2° | | PRODUCT SPEC 108-115169 | RESTRICTED TO | | | |
| MATERIAL SEE NOTE | | FINISH - | APPLICATION SPEC 114-115031 | SIZE A3 | CAGE CODE 00779 | DRAWING NO C-2367198 |
| CUSTOMER DRAWING | | | SCALE N/A | SHEET 1 OF 2 | REV A1 | |

| REVISIONS | | | | | |
|-----------|-----|-------------|------|-----|------|
| P | LTR | DESCRIPTION | DATE | DWN | APVD |
| - | - | SEE SHEET 1 | - | - | - |

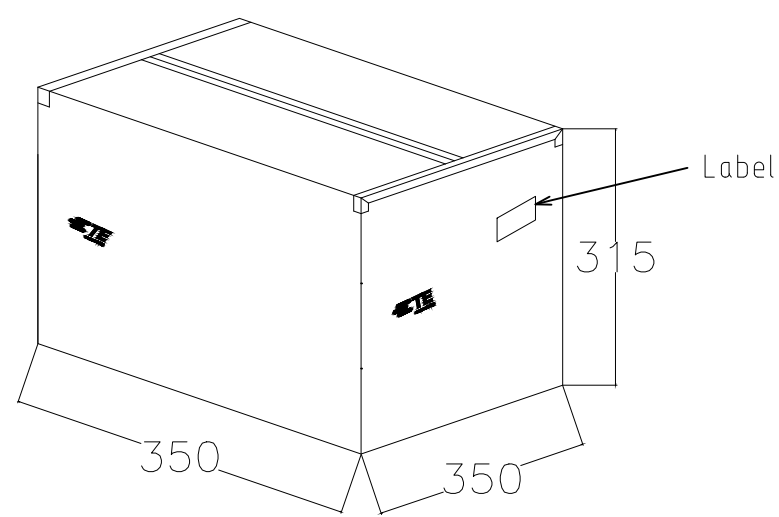
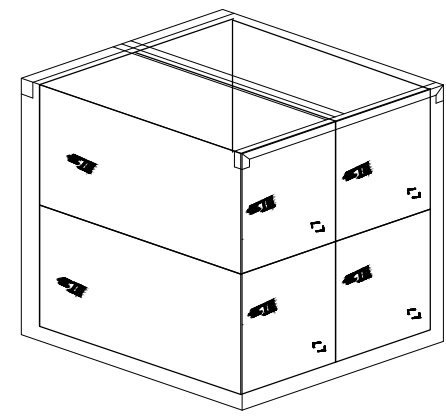
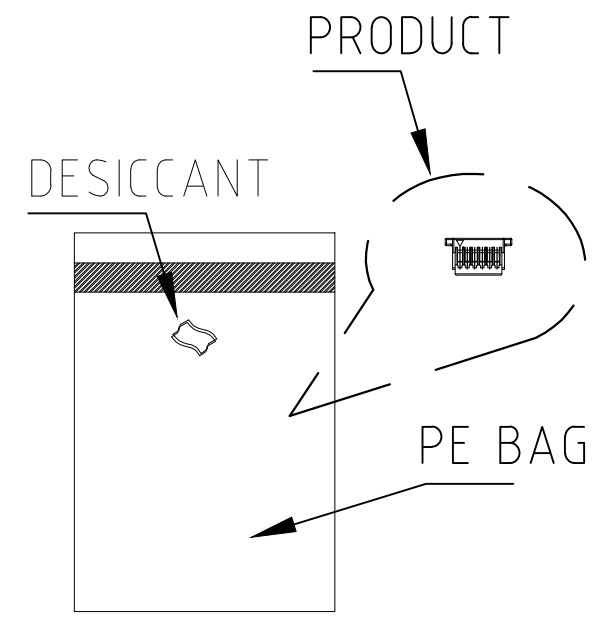
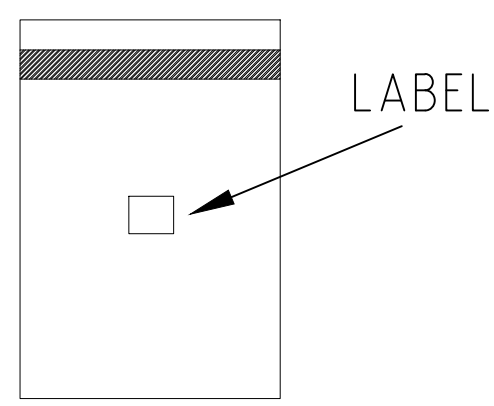
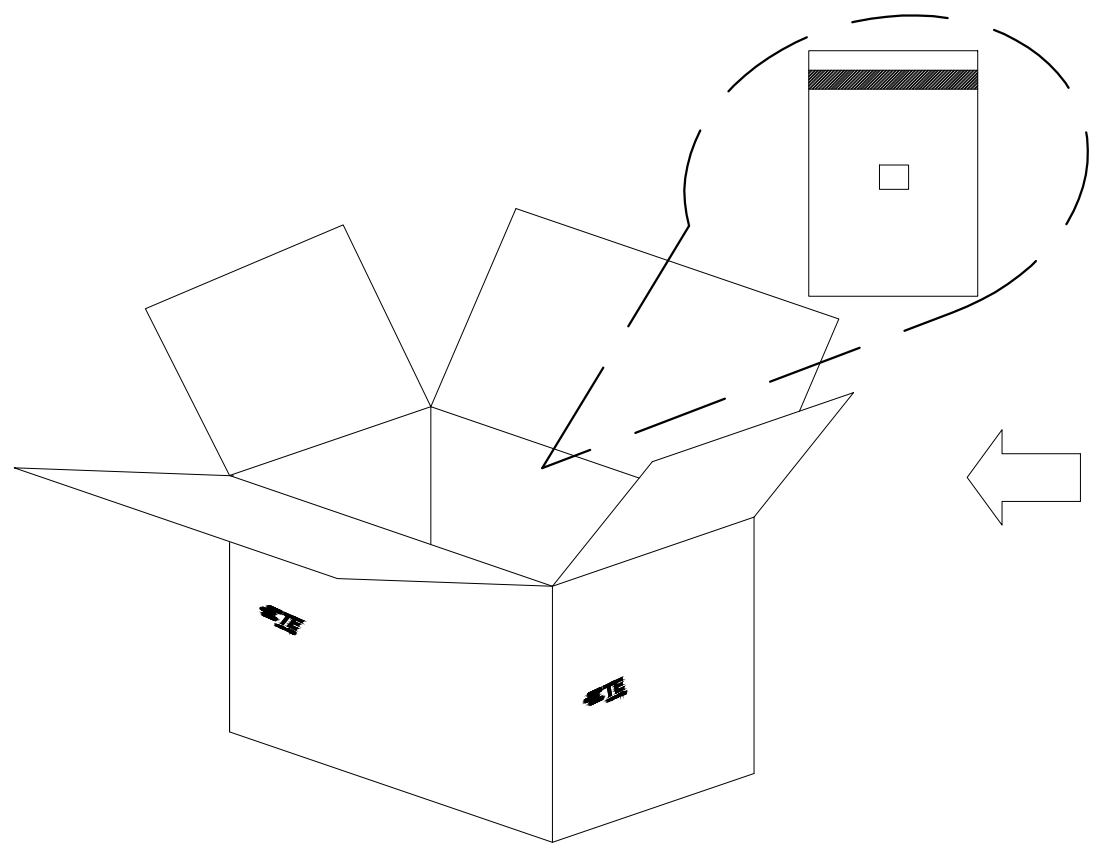

| PART NUMBER | PCS/PEG | PCS/CARTON |
|-------------|-------------|------------|
| 2-2367198-3 | 2367198-3 | 1600 |
| 2-2367198-4 | 2367198-4 | 1600 |
| 2-2367198-5 | 2367198-5 | 1600 |
| 2-2367198-6 | 2367198-6 | 1600 |
| 2-2367198-7 | 2367198-7 | 1600 |
| 2-2367198-8 | 2367198-8 | 1600 |
| 2-2367198-9 | 2367198-9 | 1600 |
| 3-2367198-0 | 1-2367198-0 | 1600 |
| 3-2367198-1 | 1-2367198-1 | 1600 |
| 3-2367198-2 | 1-2367198-2 | 1600 |
| 3-2367198-3 | 1-2367198-3 | 1600 |
| 3-2367198-4 | 1-2367198-4 | 1600 |
| 3-2367198-5 | 1-2367198-5 | 1600 |

Put 4 small carton into out carton

NOTES:
PACKAGE FOR *-2367198-*

| | | | | | |
|--|--|--------------------------------|-----------------------------------|--|--------------------|
| THIS DRAWING IS A CONTROLLED DOCUMENT. | | DWN Tommy Qian 18DEC2019 | TE Connectivity | | |
| DIMENSIONS: mm | | CHK Wenke He | | | |
| TOLERANCES UNLESS OTHERWISE SPECIFIED: | | APVD Wenke He | PRODUCT SPEC 108-115169 | | |
| 0 PLC ± 0.5 1 PLC ± 0.35 2 PLC ± 0.25 3 PLC ± 0.15 4 PLC ± - ANGLES ± * | | PRODUCT SPEC 108-115169 | | | |
| MATERIAL SEE NOTE | | FINISH - | WEIGHT A300779 | | |
| | | CUSTOMER DRAWING | | | RESTRICTED TO - |
| | | SCALE N/A | | | SHEET 2 OF 2 |
| | | REV A1 | | | |

X-ON Electronics

Largest Supplier of Electrical and Electronic Components

Click to view similar products for [Headers & Wire Housings](#) category:

Click to view products by [TE Connectivity](#) manufacturer:

Other Similar products are found below :

[892-18-020-10-001101](#) [58102-G61-06LF](#) [582553-1](#) [0009485154](#) [009176003701906](#) [0050291907](#) [LY20-4P-DT1-P1E-BR](#) [02.125.8002.8](#)
[609-3404](#) [61062-3](#) [61082-181009](#) [622-3653LF](#) [63453-116](#) [636-1030](#) [636-1427](#) [636-3427](#) [636-4007](#) [641938-9](#) [641991-4](#) [644827-2](#) [65817-](#)
[010LF](#) [65817-015LF](#) [65863-015LF](#) [66207-023LF](#) [67095-007LF](#) [67601157](#) [68645-018](#) [68648-049](#) [70.362.1628.0](#) [70-4210](#) [70-4226B](#) [70-](#)
[4853B](#) [707-5020](#) [707-5028](#) [71.350.2428.0](#) [71918-208LF](#) [71961-016LF](#) [733-134](#) [733-162](#) [754199-000](#) [760-3052](#) [787-8014-00](#) [79531-3000](#)
[FCN-360C032-B](#) [FCN-367T-T012/H](#) [FCN-723D010/2](#) [80.063.4001.1](#) [800-90-001-10-001000](#) [800-90-010-10-002000](#) [801-43-002-10-013000](#)