

CODICE AMP DI NAZIONALITA' (—••)  
 E N° IMPRONTA STAMPO (POSIZIONE OPZIONALE).  
 MANUFACTURING LOCATION CODE (—••)  
 AND MOULD POCKET NO. (OPTIONAL POSITION).

INDICATORE DELLA VIA NO.1 (FACOLTATIVO)  
 FIRST WAY IDENTIFICATION (OPTIONAL)

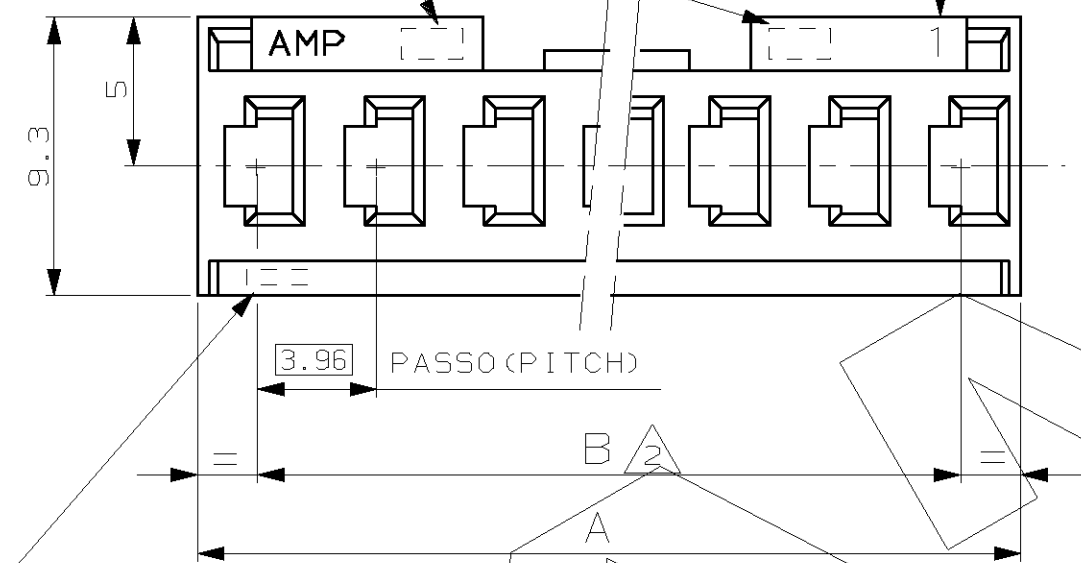
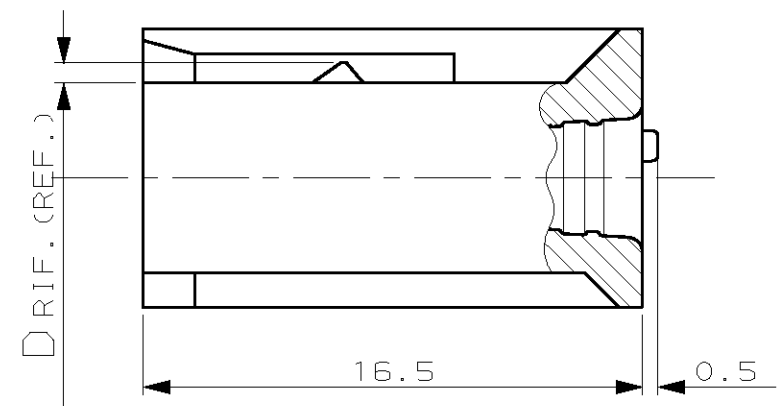

MARCHIO AMP, CODICE AMP DI NAZIONALITA' (—••) E  
 N° IMPRONTA STAMPO SOLO PER P/N 280590.  
 FOR P/N 280590 ONLY: AMP TRADEMARK, MANUFACTURING  
 LOCATION CODE (—••) AND MOULD POCKET NO.

SPORGENZE DI IDENTIFICAZIONE LATO  
 DI AGGANCIAMENTO DEL CONTATTO FEMMINA  
 (IDENTIFICATION LEDGES FOR RECEPTACLE  
 CONTACT LOCKING LANCE POSITIONING)

47.4	43.59	2.0	0.70	12	280595
39.5	35.66			10	280594
31.6	27.74			8	280593
23.7	19.81			6	280592
15.7	11.89		G	4	280591
7.8	3.96	1.0	0.25	2	280590
A	B	C	D	NO. POS.	NUMERO (PART NUMBER)

NOTE (NOTES)

- 1 MATERIALE: POLICARBONATO CAR. VETRO UL94V-1, COLORE VERDE.  
 (MATERIAL: G.F.F. POLYCARBONATE UL94V-1, COLOR GREEN).
- 2 NO. PASSI x 3.96 ; TOLLERANZA NON CUMULATIVA.  
 (NO. OF PITCHES x 3.96 ; TOLERANCE NOT CUMULATIVE).

CUSTOMER DRAWING FOR REFERENCE ONLY  
 DISEGNO PER CLIENTE SOLO PER RIFERIMENTO

THIS DRAWING IS UNPUBLISHED RELEASE FOR PUBLICATION 19

TOLLERANZE: SE NON DIVERSAMENTE SPECIFICATO  
 (TOLERANCES, UNLESS OTHERWISE SPECIFIED)  
 ± 0.3

ANGOLI (ANGLES) ± 2°

MATERIALE (MATERIAL) VEDERE NOTA (SEE NOTE) 1  
 SCALA (SCALE) 4:1

DIS. (DR.) G. CAMPIA 7 SEP 90  
 DESCRIZIONE (DESCRIPTION) AMPMODU I RECEPTACLE HOUSINGS

CONT. (CHK) -

LOC. SIZE NUMERO (DWG NO) I A3 C-280590  
 REV. (APP.) G1

G1	REVISED PER ECO-11-005294	RK	05APR 11
REV. (REV. LTR.)	REVISIONI (REVISION RECORD)	DIS. (DR.)	DATA (DATE)
APP. (APP.)		FOGLIO (SHEET) 1	DI (OF) 1

DISTRIBUZIONE (PRINT DIST.)

## X-ON Electronics

Largest Supplier of Electrical and Electronic Components

*Click to view similar products for [Headers & Wire Housings](#) category:*

*Click to view products by [TE Connectivity](#) manufacturer:*

Other Similar products are found below :

[892-18-020-10-001101](#) [58102-G61-06LF](#) [582553-1](#) [0009485154](#) [009176003701906](#) [0050291907](#) [LY20-4P-DT1-P1E-BR](#) [02.125.8002.8](#)  
[609-3404](#) [61062-3](#) [61082-181009](#) [622-3653LF](#) [63453-116](#) [636-1030](#) [636-1427](#) [636-3427](#) [636-4007](#) [641938-9](#) [641991-4](#) [644827-2](#) [65817-](#)  
[010LF](#) [65817-015LF](#) [65863-015LF](#) [66207-023LF](#) [67095-007LF](#) [67601157](#) [68645-018](#) [68648-049](#) [70.362.1628.0](#) [70-4210](#) [70-4226B](#) [70-](#)  
[4853B](#) [707-5020](#) [707-5028](#) [71.350.2428.0](#) [71918-208LF](#) [71961-016LF](#) [733-134](#) [733-162](#) [754199-000](#) [760-3052](#) [79531-3000](#) [FCN-](#)  
[360C032-B](#) [FCN-367T-T012/H](#) [FCN-723D010/2](#) [80.063.4001.1](#) [800-90-010-10-002000](#) [801-43-002-10-013000](#) [801-43-006-10-002000](#)  
[801-93-011-10-001000](#)