

P	LTR	DESCRIPTION	DATE	DWN	APVD
	E1	6 POS PART 1-282845-4 ADDED	29 JUN 2020	SS	PS

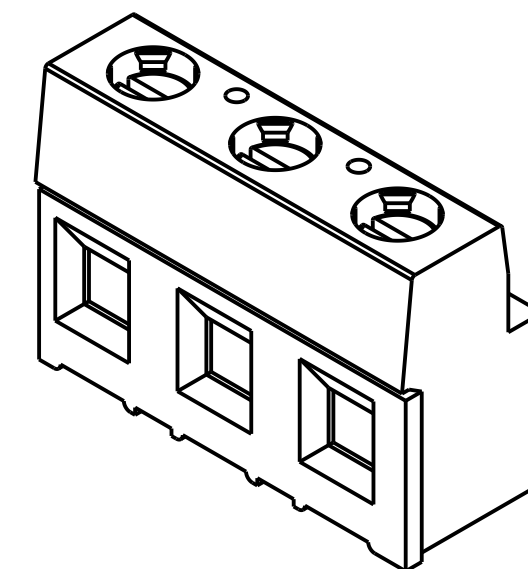

282845-3 AS SHOWN

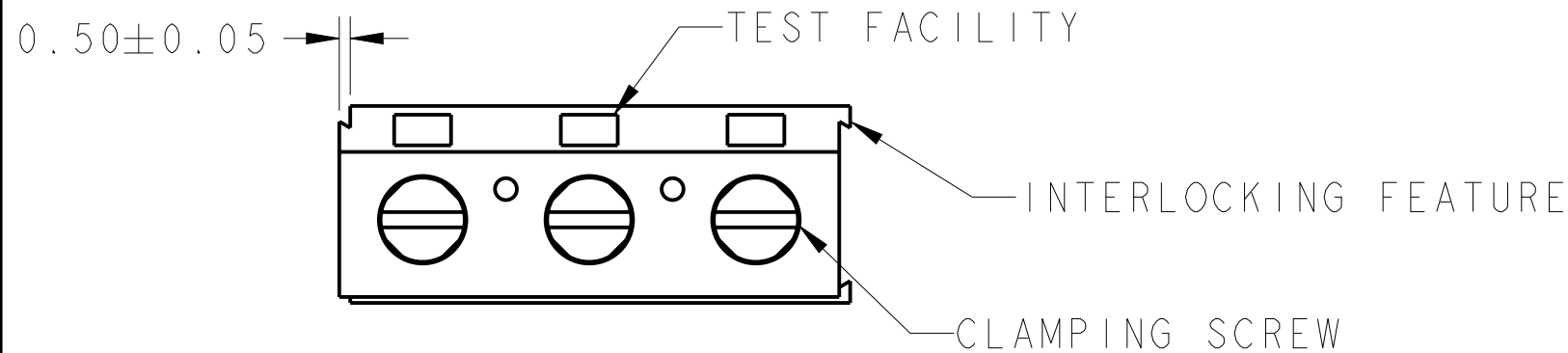
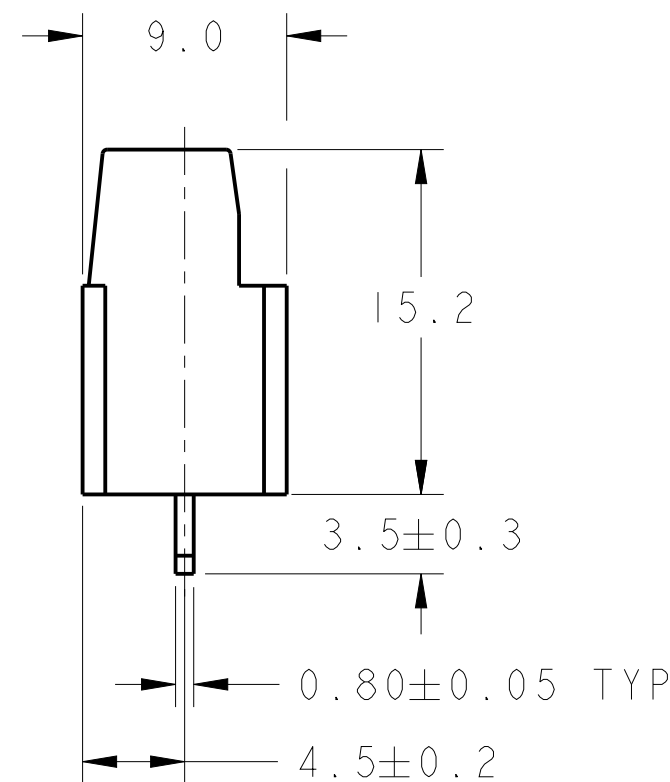
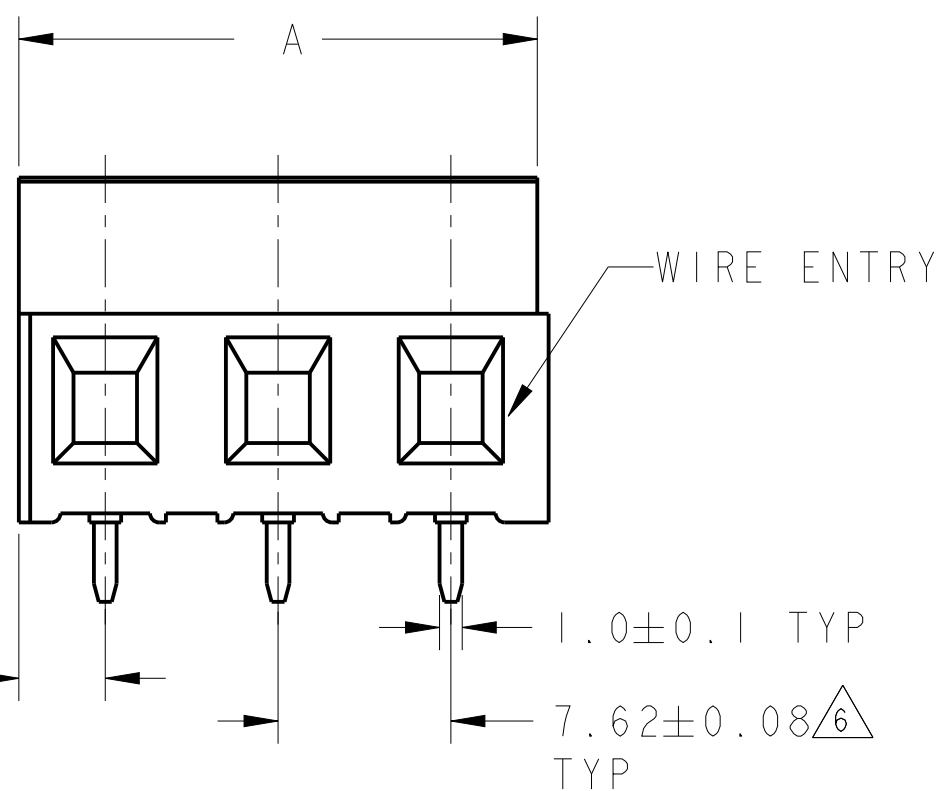

-	45.72	6	△9	1-282845-4
△7	SEE SHEET 2	22.86	3	1-282845-3
△7	SEE SHEET 2	68.58	9	△8 1-282845-2
△7	SEE SHEET 2	22.86	3	1-282845-1
△7	SEE SHEET 2	15.24	2	1-282845-0
△7	SEE SHEET 2	15.24	2	282845-9
△7	SEE SHEET 2	22.86	3	282845-8
△7	SEE SHEET 2	15.24	2	282845-7
△7	SEE SHEET 2	15.24	2	282845-6
△7	SEE SHEET 2	22.86	3	282845-5
-	22.86	3		282845-3
-	15.24	2		282845-2
MARKING		DIM A	POS	PART NUMBER

RECOMMENDED PC BOARD LAYOUT

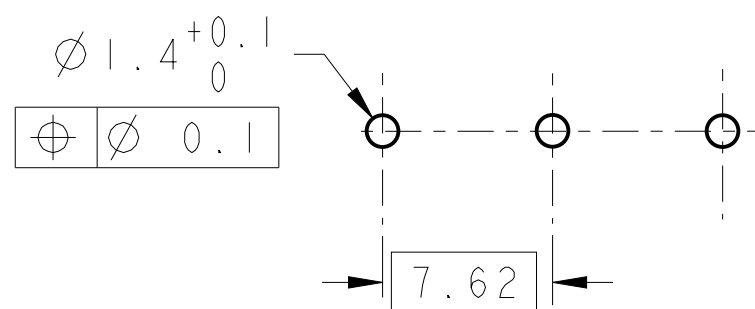

THIS DRAWING IS A CONTROLLED DOCUMENT.		DWN E. ZANOLINI 16AUG2001	TE Connectivity	
DIMENSIONS: mm		CHK D. BIEVENOUR 16AUG2001		
TOLERANCES UNLESS OTHERWISE SPECIFIED:		APVD D. BIEVENOUR 16AUG2001	NAME TERMINAL BLOCK PCB MOUNT SIDE WIRE ENTRY, STACKING W/INTERLOCK, 7.62mm PITCH	
0 PLC ±- 1 PLC ±.3 2 PLC ±.25 3 PLC ±- 4 PLC ±- ANGLES ±°		PRODUCT SPEC	RESTRICTED TO	
MATERIAL		APPLICATION SPEC 114-20079	SIZE A3	CAGE CODE 00779
FINISH		WEIGHT -	DRAWING NO C-282845	
		CUSTOMER DRAWING	SCALE 3:1	SHEET 1 OF 2
				REV E1

P	LTR	DESCRIPTION	DATE	DWN	APVD
-		SEE SHEET 1	-	-	-

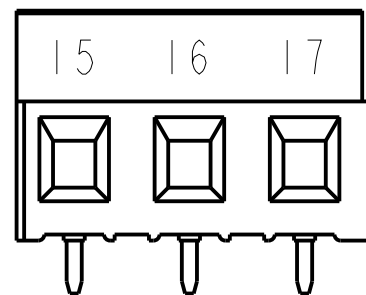

P/N 282845-5 AS SHOWN

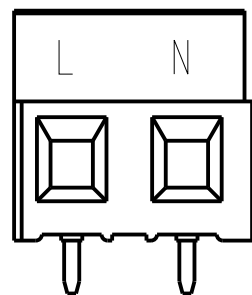

P/N 282845-6 AS SHOWN

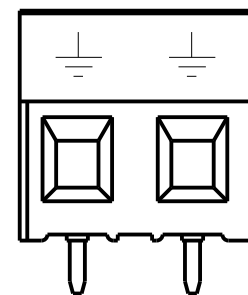

P/N 282845-7 AS SHOWN

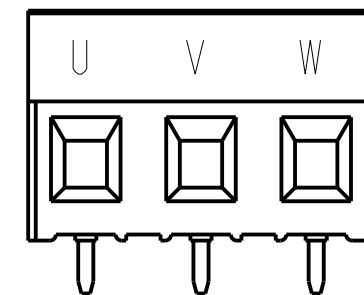

P/N 282845-8 AS SHOWN

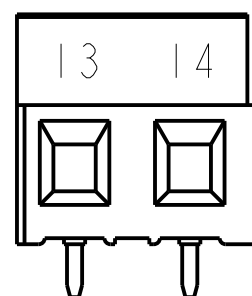

P/N 282845-9 AS SHOWN

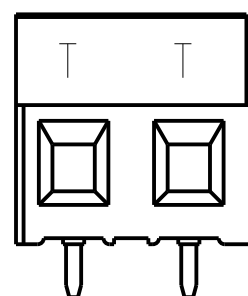

P/N 1-282845-0 AS SHOWN

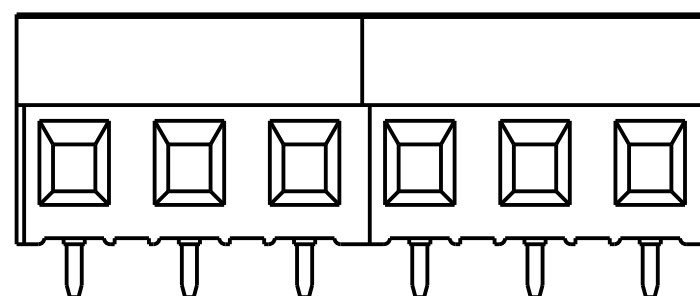

P/N 1-282845-4 AS SHOWN

1. MATERIALS AND FINISH
 HOUSING: PA 6-6, UL 94-V0, COLOR GREEN.
 CLAMP: BRASS, NICKEL PLATED.
 TERMINAL: BRASS, TIN PLATED.
 CLAMPING SCREW: M3, BRASS, NICKEL PLATED

- 2. SUITABLE FOR 1,6-2,4mm. PCB THICKNESS.
- 3. END-TO-END STACKABLE W/INTERLOCK WITHOUT LOSS OF CENTERLINE SPACING.
- 4. WIRE SIZE RANGE : 30-12 AWG
- 5. RECOGNIZED UNDER THE COMPONENT PROGRAM OF UNDERWRITERS LABORATORIES INC. FILE NO E60677.

- 6. NOT CUMULATIVE TOLERANCE.
- 7. INK MARKING, BLACK COLOR
- 8. P/N 1-282845-2 IS OBTAINED BY GLUING AND ASSEMBLING TOGETHER No.1 CONNECTOR P/N 282845-6, No.1 CONNECTOR P/N 282845-7, No.1 CONNECTOR P/N 282845-8 AND No.1 CONNECTOR P/N 1-282845-0
- 9. P/N 1-282845-4 IS OBTAINED BY INTERLOCKING 2 NO. OF CONNECTOR P/N 282845-3.

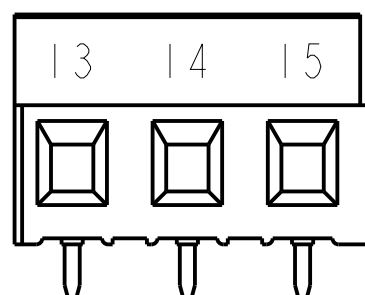

P/N 1-282845-1 AS SHOWN

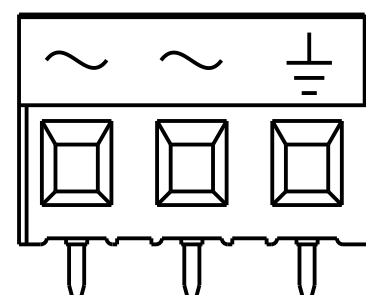

P/N 1-282845-3 AS SHOWN

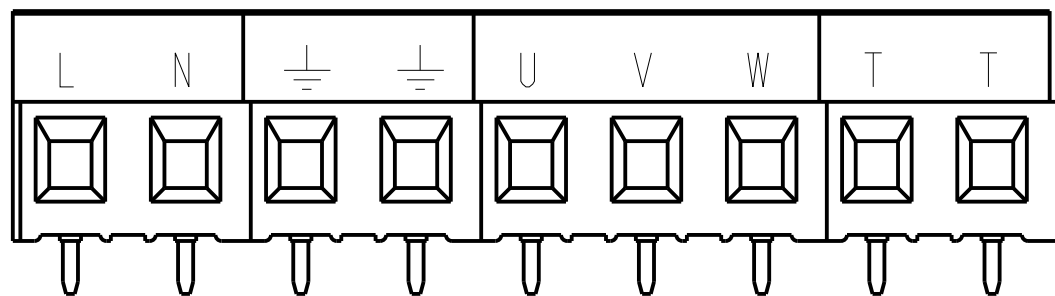

P/N 1-282845-2 AS SHOWN

THIS DRAWING IS A CONTROLLED DOCUMENT.

DIMENSIONS:	TOLERANCES UNLESS OTHERWISE SPECIFIED:
mm	
0 PLC	±0
1 PLC	±.3
2 PLC	±.25
3 PLC	±
4 PLC	±
ANGLES	±2°

MATERIAL	FINISH
1	1

DWN	E. ZANOLINI	16AUG2001
CHK	D. BIEVENOUR	16AUG2001
APVD	D. BIEVENOUR	16AUG2001
PRODUCT SPEC	108-20166	
APPLICATION SPEC	114-20079	
WEIGHT	-	

TE TE Connectivity			
NAME TERMINAL BLOCK PCB MOUNT SIDE WIRE ENTRY, STACKING W/INTERLOCK, 7.62mm PITCH			
SIZE	CAGE CODE	DRAWING NO	RESTRICTED TO
A3	00779	C=282845	-
CUSTOMER DRAWING		SCALE	SHEET
		2:1	2 OF 2
		REV	E1

X-ON Electronics

Largest Supplier of Electrical and Electronic Components

Click to view similar products for [Fixed Terminal Blocks](#) category:

Click to view products by [TE Connectivity](#) manufacturer:

Other Similar products are found below :

[MBE-1512](#) [MBE-154](#) [MBE-156](#) [MBES-153](#) [MBES-156](#) [MH-2512](#) [MHE-132](#) [MHE-163](#) [MI-254 \(35\)](#) [MI-272](#) [880507](#) [MPT-275](#)
[15602-04-08-21](#) [BA311TU](#) [BA411SU](#) [MV-152](#) [MV-252-D](#) [MV-253/NCNOC](#) [MV-254-D](#) [MV-255](#) [MV-462](#) [MV-493](#) [MVE-252](#) [MVE-253](#)
[MVE-273](#) [MVEB-153](#) [1700096](#) [1705142](#) [1712417](#) [1713020](#) [1713088](#) [1745195](#) [1760594](#) [1776118-2](#) [1790852](#) [1-796689-8](#) [1-796692-6](#)
[1800001](#) [1800114](#) [1995279](#) [20020314-C121B01LF](#) [20020316-G041B01LF](#) [CB2-12](#) [KP03215000J0G](#) [KP04215000J0G](#) [S451](#) [282802-2](#)
[29.007](#) [29.116](#) [30.103](#)