

THIS DRAWING IS UNPUBLISHED. RELEASED FOR PUBLICATION 20
 © COPYRIGHT 20 BY - ALL RIGHTS RESERVED.

REVISIONS				
P	LTR	DESCRIPTION	DATE	APVD
D3		PN 282861-4 IS REACTIVATED	17JUL2018	RK PS

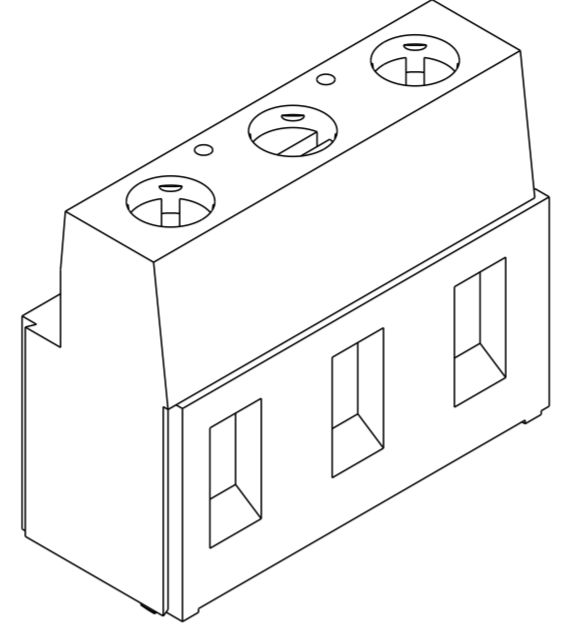
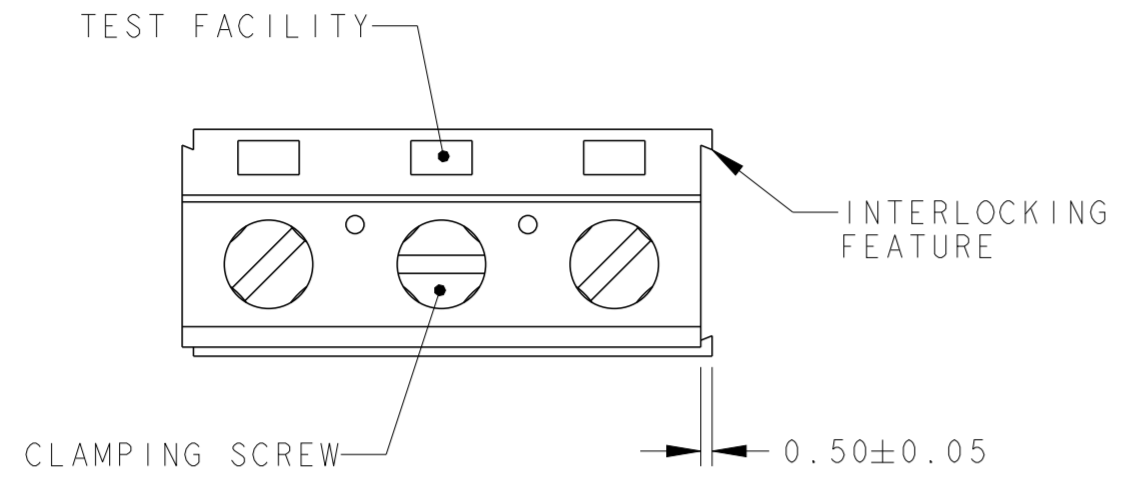

282861-3 AS SHOWN

NOTES:

- MATERIALS AND FINISH
 HOUSING: PA 6-6, UL 94-V0, COLOR: SEE TABLE.
 CLAMP: BRASS, NICKEL PLATED.
 TERMINAL: BRASS, TIN PLATED.
 CLAMPING SCREW: M3, BRASS, NICKEL PLATED.
 - MECHANICAL
 MIN. PC BOARD HOLES DIAMETER : 1.4 mm
 MAX. PC BOARD THICKNESS : 2.4 mm
 WIRE STRIPPING LENGTH : 6.5 - 7.0 mm
 RECOMMENDED TIGHTENING TORQUE FOR SCREW : 0.5 Nm.
 - ELECTRICAL
 WIRE RANGE : 12-30 AWG
 MAX. VOLTAGE : 300 V
 MAX. CURRENT : 24 A
 CONTACT RESISTANCE : <15 m Ohm
 INSULATION RESISTANCE : >1000 M Ohm (500V DC)
 - END-TO-END STACKABLE W/INTERLOCK WITHOUT LOSS OF CENTERLINE SPACING.
 - RECOGNIZED UNDER THE COMPONENT PROGRAM OF UNDERWRITERS LABORATORIES INC. FILE NO E60677.
- △6 NOT CUMULATIVE TOLERANCE.
 △7 INK MARKING, BLACK COLOR.

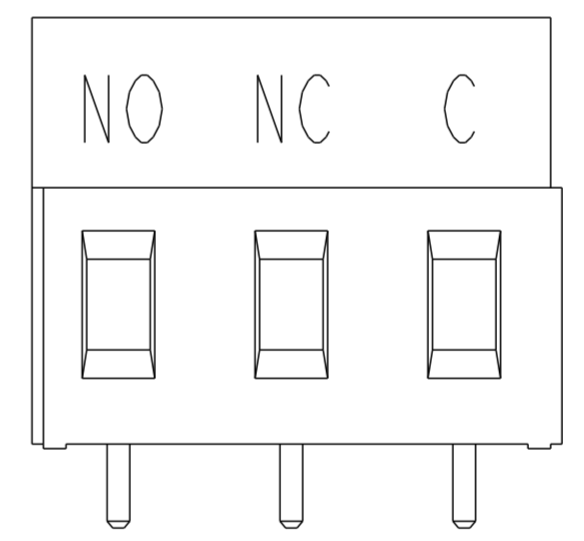
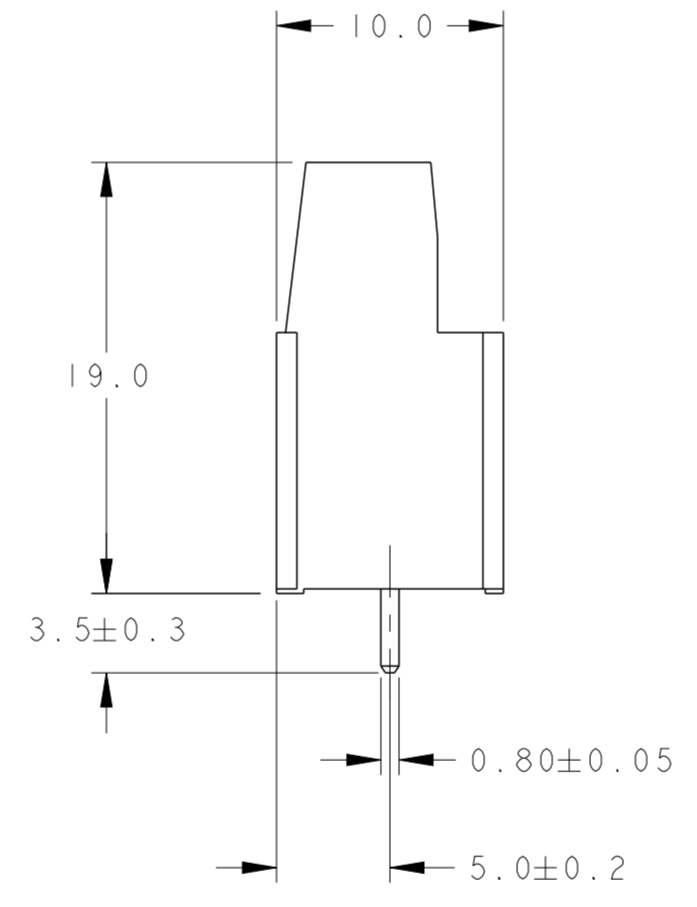
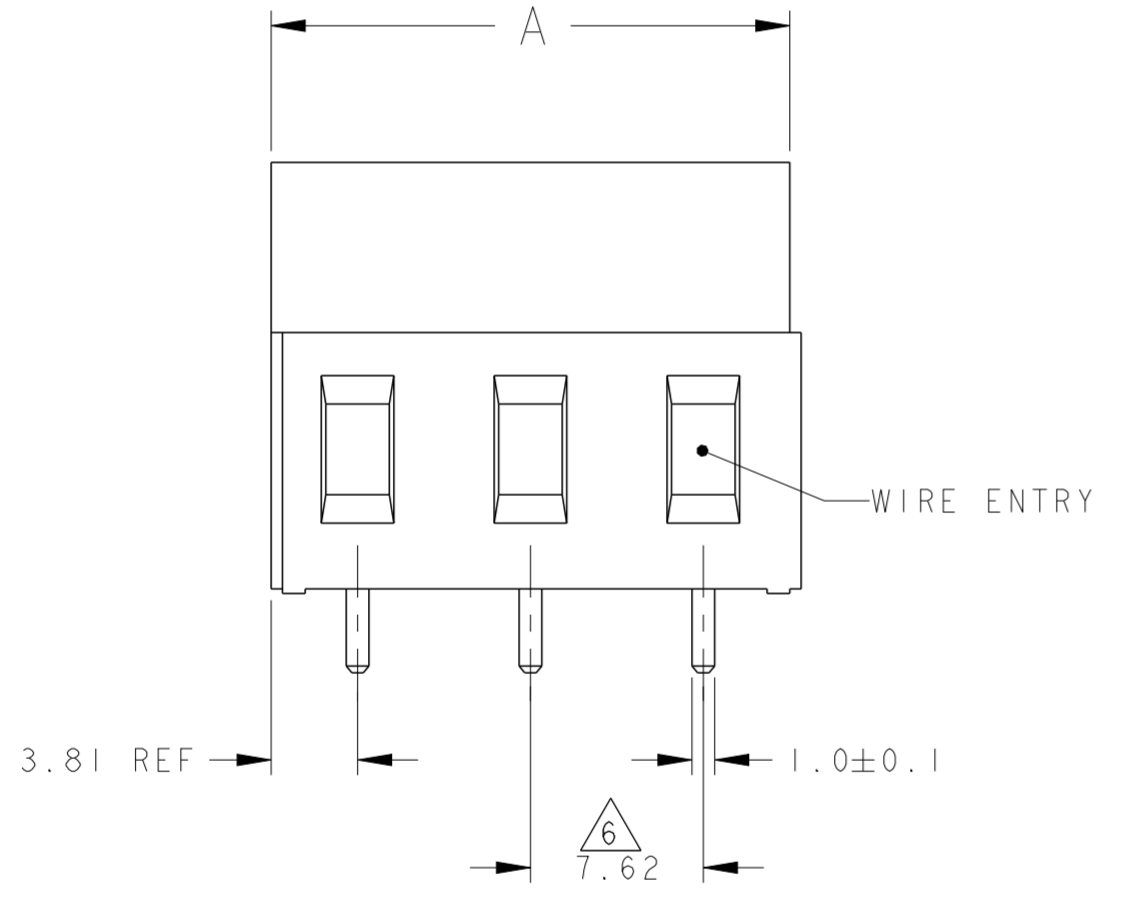

DETAIL L △7

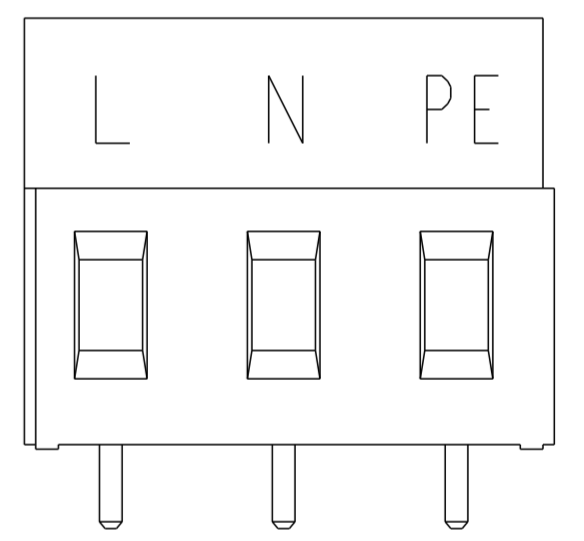

DETAIL M △7

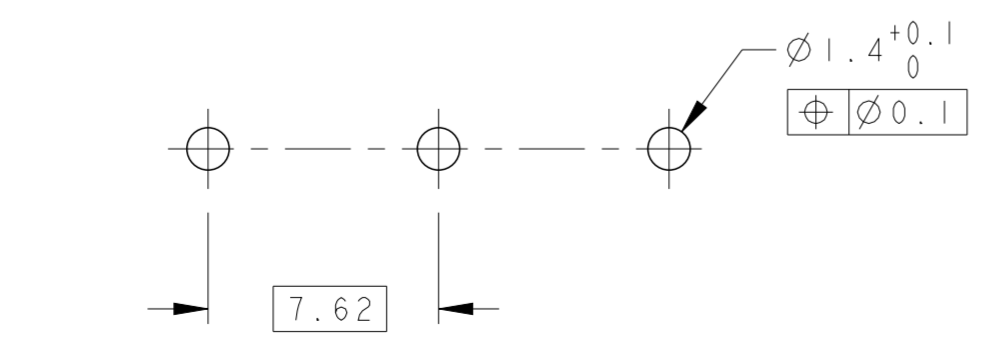

RECOMMENDED PC BOARD LAYOUT

GREEN	SEE DETAIL M	22.86	3	282861-5
GRAY	SEE DETAIL L	22.86	3	282861-4
GREEN	-	22.86	3	282861-3
GREEN	-	15.24	2	282861-2
HOUSING COLOR	MARKING	A	NO OF POSN	PART NUMBER

THIS DRAWING IS A CONTROLLED DOCUMENT.		DWN E. ZANOLINI 24OCT2001	TE Connectivity	
DIMENSIONS: mm		CHK D. BIEVENOUR 24OCT2001		
TOLERANCES UNLESS OTHERWISE SPECIFIED:		APVD D. BIEVENOUR 24OCT2001	NAME	
0 PLC ±		PRODUCT SPEC	TERMINAL BLOCK, PCB MOUNT	
1 PLC ±0.3		108-20166	SIDE ENTRY WIRE, STACKING	
2 PLC ±0.25		APPLICATION SPEC	W/ INTERLOCK, 7.62mm PITCH	
3 PLC ±		114-20079	SIZE	RESTRICTED TO
4 PLC ±		WEIGHT	A20779	
ANGLES ±2°		CUSTOMER DRAWING	CAGE CODE	DRAWING NO
FINISH		SCALE 3:1	G-282861	SHEET 1 OF 1
MATERIAL SEE NOTES	SEE NOTES			REV D3

X-ON Electronics

Largest Supplier of Electrical and Electronic Components

Click to view similar products for [Fixed Terminal Blocks](#) category:

Click to view products by [TE Connectivity](#) manufacturer:

Other Similar products are found below :

[MBE-1512](#) [MBE-154](#) [MBE-156](#) [MBES-153](#) [MBES-156](#) [MH-2512](#) [MHE-132](#) [MHE-163](#) [MI-254 \(35\)](#) [MI-272](#) [880507](#) [MPT-275](#)
[15602-04-08-21](#) [ELM023100](#) [BA311TU](#) [BA411SU](#) [MV-152](#) [MV-252-D](#) [MV-253/NCNOC](#) [MV-254-D](#) [MV-255](#) [MV-462](#) [MV-493](#) [MVE-](#)
[253](#) [MVE-273](#) [MVEB-153](#) [1700096](#) [1705142](#) [1712417](#) [1713020](#) [1713088](#) [1745195](#) [1760594](#) [1776118-2](#) [1790852](#) [1-796689-8](#) [1-796692-6](#)
[1800001](#) [1800114](#) [1995279](#) [20020314-C121B01LF](#) [CB2-12](#) [KP03215000J0G](#) [KP04215000J0G](#) [S451](#) [282802-2](#) [29.007](#) [29.116](#) [30.103](#)
[30.106](#)