

THIS DRAWING IS UNPUBLISHED.

RELEASED FOR PUBLICATION

20

© COPYRIGHT 20

ALL RIGHTS RESERVED.

REVISIONS

P	LTR	DESCRIPTION	DATE	DWN	APVD
	C2	REVISED PER ECO-13-017507	08NOV2013	KH	MB

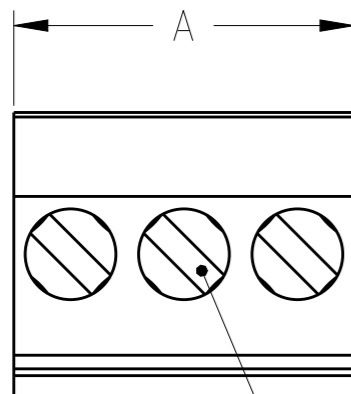

WIRE ENTRY CLAMPING SCREW

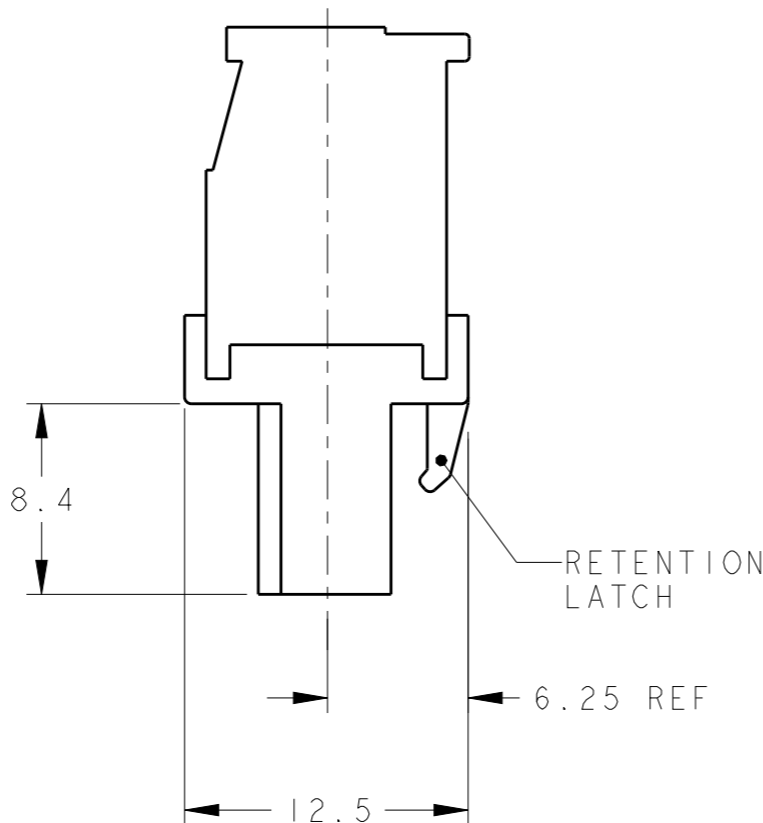
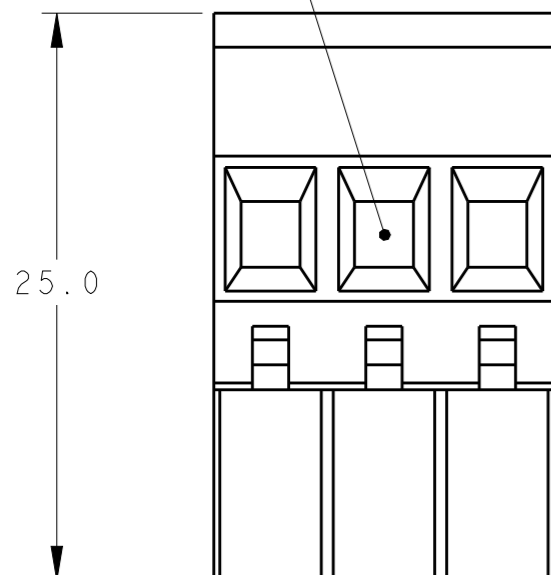

RETENTION LATCH

6.25 REF

MATING FACE

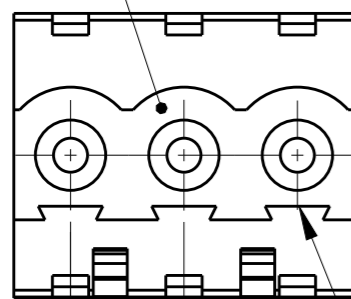

POLARIZATION KEY SLOT

2.5 REF TYP

5.00 ± 0.05 \triangle 3 TYP

SEE DETAIL N	TIN PLATED	30	6	3-284040-6
SEE DETAIL M		110	22	3-284040-2
-	\triangle 4	25	5	2-284040-6
-		125	25	2-284040-5
-		120	24	2-284040-4
-		115	23	2-284040-3
-		110	22	2-284040-2
-		105	21	2-284040-1
-		100	20	2-284040-0
-		95	19	1-284040-9
-		90	18	1-284040-8
-		85	17	1-284040-7
-		80	16	1-284040-6
-		75	15	1-284040-5
-		70	14	1-284040-4
-		65	13	1-284040-3
-		60	12	1-284040-2
-		55	11	1-284040-1
-		50	10	1-284040-0
-		45	9	284040-9
-		40	8	284040-8
-		35	7	284040-7
-		30	6	284040-6
-		25	5	284040-5
-		20	4	284040-4
-		15	3	284040-3
-		10	2	284040-2
MARKING	CONTACT FINISH	A	NO OF POSN	PART NUMBER

THIS DRAWING IS A CONTROLLED DOCUMENT.

DWN S. WELDON 03SEP2002

CHK C. RICHARD 03SEP2002

APVD C. RICHARD 03SEP2002

NAME
STE TE Connectivity
 TERMINAL BLOCK VERTICAL PLUG
 STACKING LEFT HAND
 5.0mm PITCH

DIMENSIONS:	TOLERANCES UNLESS OTHERWISE SPECIFIED:
mm	
	0 PLC ±.3
	1 PLC ±.3
	2 PLC ±.25
	3 PLC ±.
	4 PLC ±.
	ANGLES ±2

MATERIAL	FINISH
\triangle 1	\triangle 1

PRODUCT SPEC	APPLICATION SPEC	WEIGHT
-	-	-

SIZE	CAGE CODE	DRAWING NO	RESTRICTED TO
A3	00779	C-284040	-

CUSTOMER DRAWING SCALE 3:1 SHEET 1 OF 2 REV C2

THIS DRAWING IS UNPUBLISHED.

RELEASED FOR PUBLICATION

20

© COPYRIGHT 20

ALL RIGHTS RESERVED.

REVISIONS

P	LTR	DESCRIPTION	DATE	DWN	APVD
-		SEE SHEET 1	-	-	-

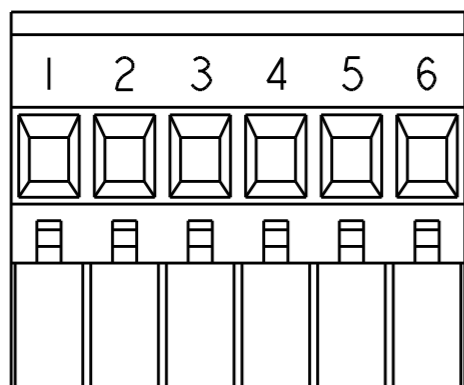

DETAIL N
SCALE 2:1 $\triangle 5$

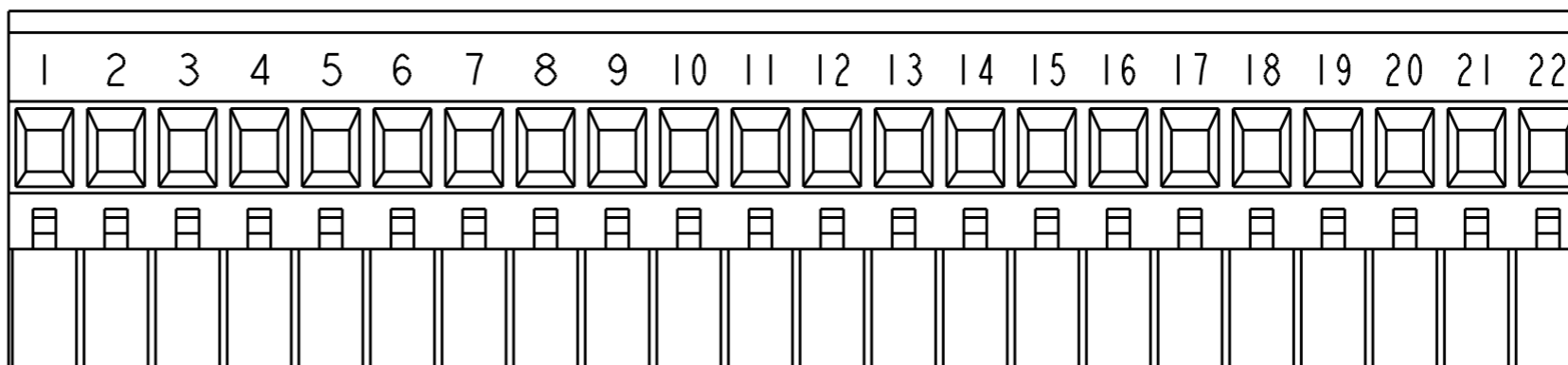

DETAIL M
SCALE 2:1 $\triangle 5$

- $\triangle 1$ MATERIALS AND FINISH
HOUSING: PA 6-6, UL 94-V0, COLOR: GREEN.
CLAMP: BRASS, NICKEL PLATED.
CONTACT SPRING : PHOSPHOR BRONZE, TIN PLATED.
CLAMPING SCREW: M3, BRASS, NICKEL PLATED.
- 2. WIRE SIZE RANGE: 12 - 30 AWG
- $\triangle 3$ NOT CUMULATIVE TOLERANCE.
- $\triangle 4$ 0.00076[.000030] SELECTIVELY GOLD PLATED.
- $\triangle 5$ INK MARKING: WHITE COLOR
NUMERICAL SEQUENCE: FROM LEFT TO RIGHT.
- 6 MECHANICAL CHARACTERISTICS:
INSERTION FORCE: MAX 3N PER POLE
WITHDRAWL FORCE: MIN 1.5N PER POLE
- 7 ELECTRICAL CHARACTERISTICS:
LISTED UNDER UL E60677
VOLTAGE RATING: 300 VOLTS (MAX)
AMPERAGE RATING: 15 AMPS (MAX)

THIS DRAWING IS A CONTROLLED DOCUMENT.		DWN S. WELDON 03SEP2002	 TE Connectivity	
DIMENSIONS: mm		CHK C. RICHARD 03SEP2002		
TOLERANCES UNLESS OTHERWISE SPECIFIED:		APVD C. RICHARD 03SEP2002	NAME TERMINAL BLOCK VERTICAL PLUG STACKING LEFT HAND 5.0mm PITCH	
0 PLC \pm - 1 PLC \pm .3 2 PLC \pm .25 3 PLC \pm - 4 PLC \pm - ANGLES \pm 2		PRODUCT SPEC -	RESTRICTED TO -	
MATERIAL -		FINISH -	APPLICATION SPEC -	SIZE A3
		WEIGHT -	CAGE CODE 00779	DRAWING NO C-284040
		CUSTOMER DRAWING	SCALE 3:1	SHEET 2 OF 2
			REV C2	

X-ON Electronics

Largest Supplier of Electrical and Electronic Components

Click to view similar products for [Pluggable Terminal Blocks](#) category:

Click to view products by [TE Connectivity](#) manufacturer:

Other Similar products are found below :

[57.510.0053](#) [MC 1.5/ 6-ST-3.5 GY AU](#) [ET02015000J0G](#) [734-104](#) [734-302](#) [8-141-P](#) [8426620000](#) [860505](#) [860516](#) [860810](#) [GBPACX-12](#)
[93.731.4953.0](#) [PV05-5,08-K](#) [PVP02-5,00](#) [PVP03-3,50](#) [PVP04-3,50](#) [PVS02-5,00](#) [1-1986160-3](#) [1377680000](#) [1531000000](#) [1546228-5](#)
[ELFH16150](#) [ELFP03110](#) [ELFP10210](#) [ELFT06250](#) [ELVP03100](#) [1700101](#) [1700410](#) [1700425](#) [1702246](#) [1705229](#) [1710175](#) [1714537](#) [1717806](#)
[1719600](#) [1728941](#) [1734692](#) [1734795](#) [1736036](#) [1740194](#) [1740291](#) [1740628](#) [1740990](#) [1746952](#) [1750207](#) [1752441](#) [1752865](#) [1754115](#)
[1754144](#) [1756913](#)