

P	LTR	DESCRIPTION	DATE	DWN	APVD
	D	DESIGN IMPROVEMENT IN NEW MOLD	13AUG2020	DV	PS

$\triangle 7$ 5.08^{+0.05}_{-0.10}
 TYP
 1.00±0.02
 TYP
 2.54^{+0.05}_{-0.10}
 TYP

- $\triangle 1$ MATERIALS AND FINISH:
 HOUSING: HIGH TEMPERATURE POLYAMIDE, UL 94-V0, COLOR GREEN.
 TERMINAL: COPPER ALLOY, TIN PLATED.
- SUITABLE FOR 1.6-2.4mm PC BOARD THK.
 - ELECTRICAL
 RATED VOLTAGE : 300 V
 RATED CURRENT : 12 A
 CONTACT RESISTANCE : < 15 mΩ
 INSULATION RESISTANCE : > 1000 MΩ (500V DC)
 - OPERATING TEMPERATURE RANGE: -40°C TO +110°C
 - P/N FROM 284065-4 TO 2-284065-5 ARE OBTAINED BY ASSEMBLING DIFFERENT MONOLITHIC MODULES CHOSEN AMONG: 284065-2 AND 284065-3, IN ORDER TO REALIZE THE DESIRED NO. OF WAYS.

- $\triangle 6$ MODULES AND KEYS TE BE GLUED IN PLACE.
 $\triangle 7$ NON CUMULATIVE TOLERANCE

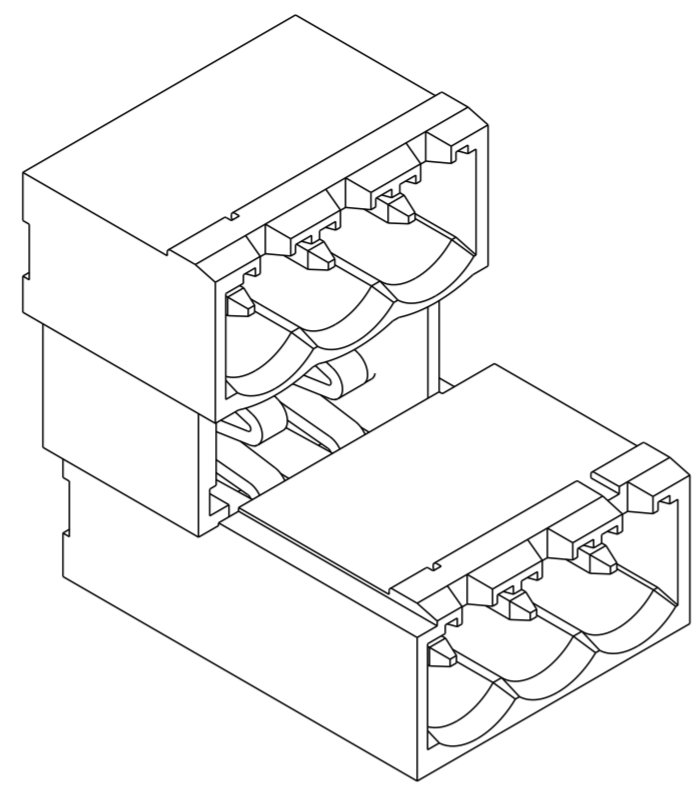

264065-3 AS SHOWN

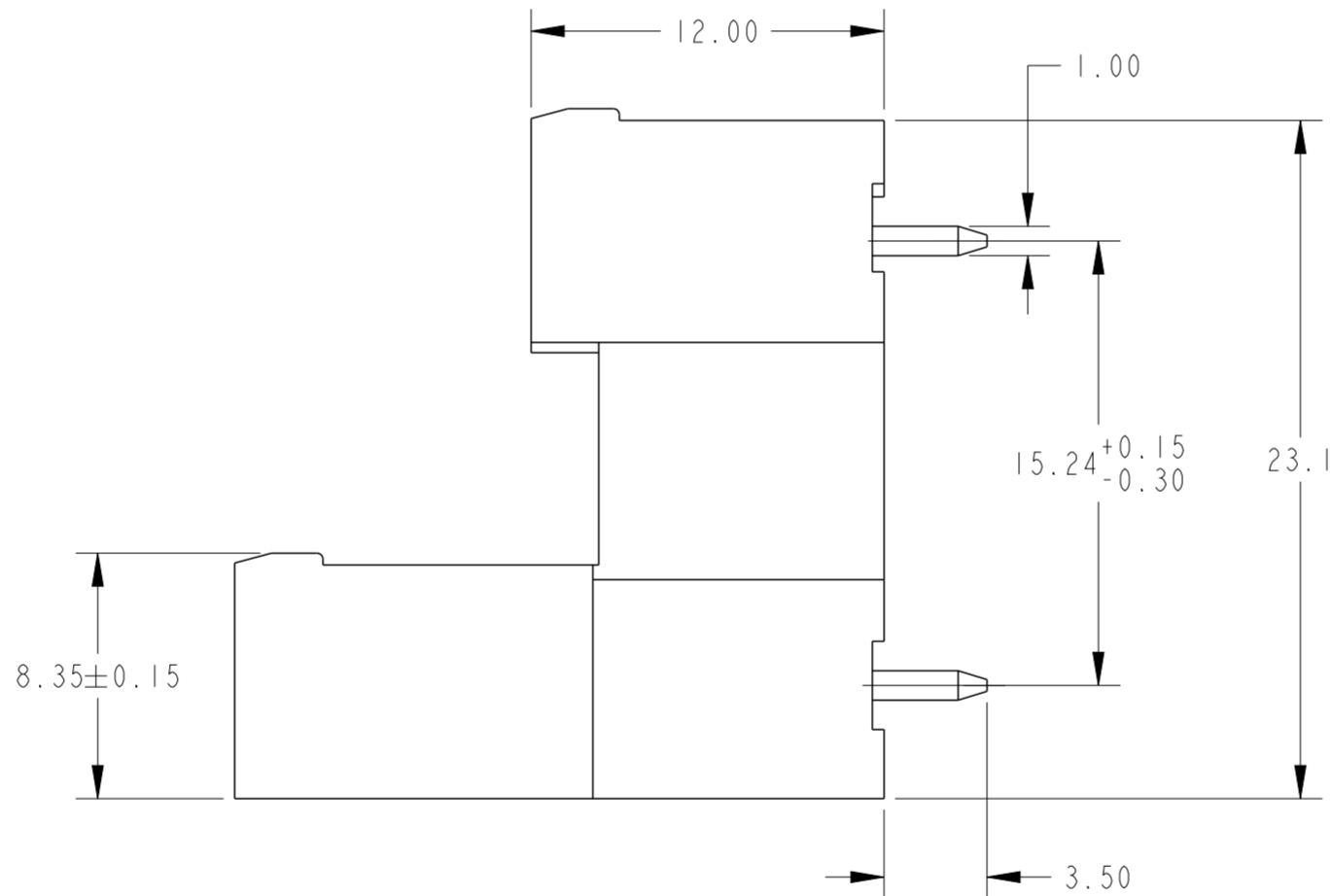
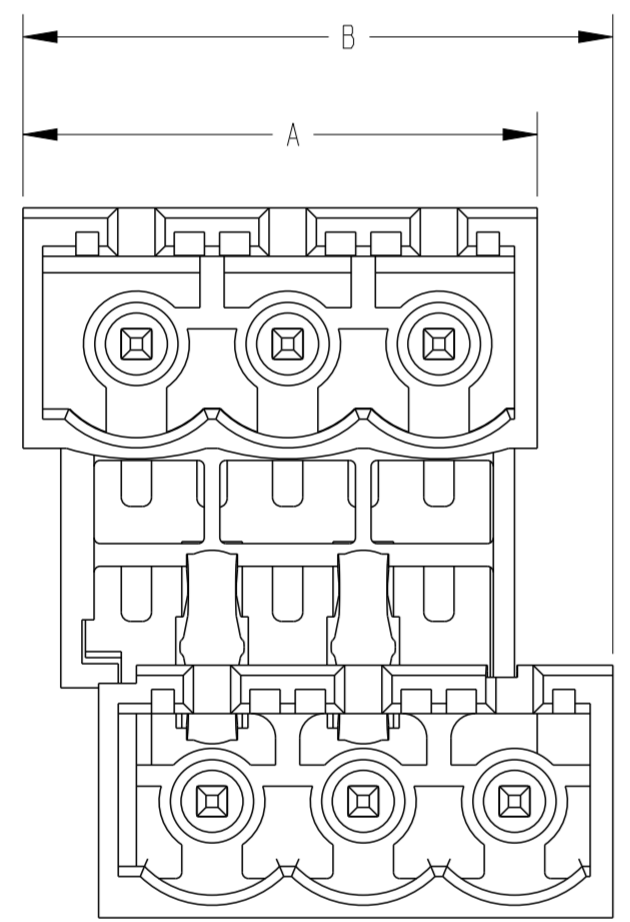
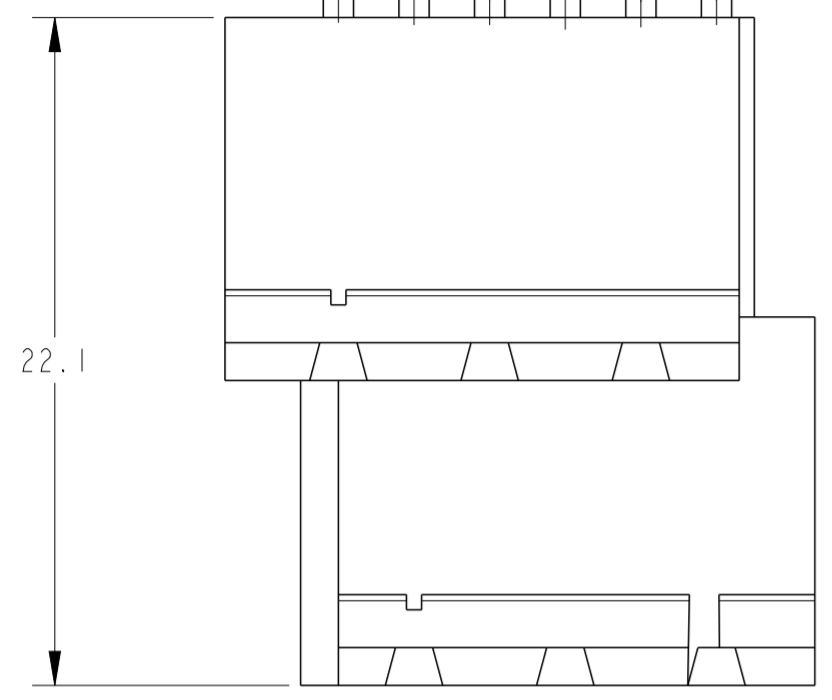

RECOMMENDED PC BOARD LAYOUT

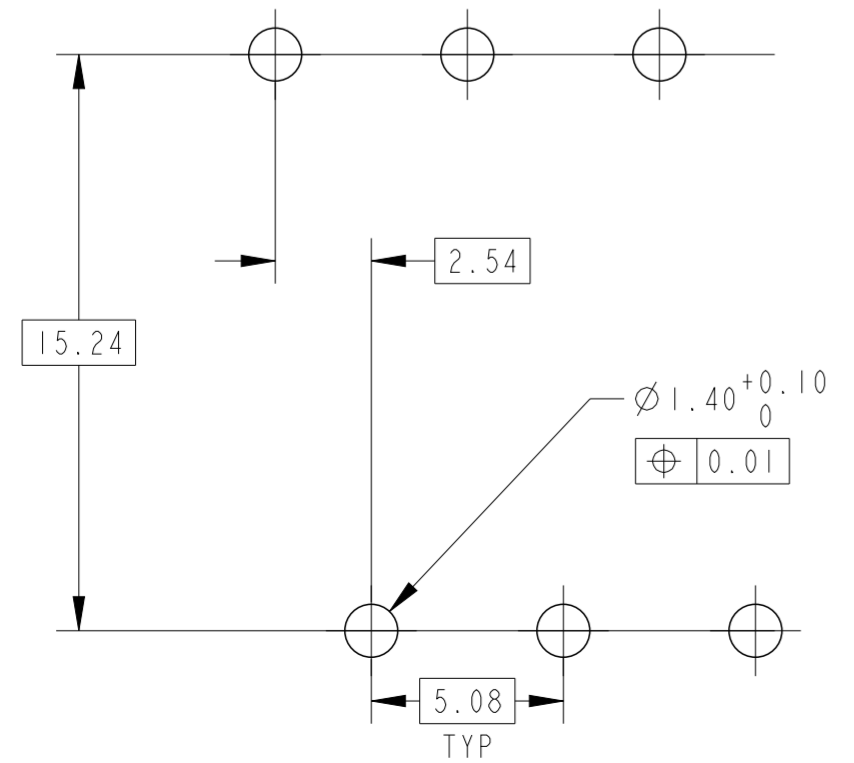

$\triangle 6$	108.44	110.94	21	3-284065-3
$\triangle 6$	77.96	80.46	15	3-284065-2
$\triangle 6$	83.08	85.58	16	3-284065-1
$\triangle 6$	123.68	126.18	24	3-284065-0
$\triangle 6$	123.68	126.18	24	2-284065-9
$\triangle 6$	93.2	95.7	18	2-284065-8
$\triangle 6$	83.08	85.58	16	2-284065-7
$\triangle 6$	62.72	65.22	12	2-284065-6
	128.8	131.3	25	2-284065-5
	123.68	126.18	24	2-284065-4
	118.64	121.14	23	2-284065-3
	113.56	116.06	22	2-284065-2
	108.44	110.94	21	2-284065-1
	103.4	105.9	20	2-284065-0
	98.32	100.82	19	1-284065-9
	93.2	95.7	18	1-284065-8
	88.16	90.66	17	1-284065-7
	83.08	85.58	16	1-284065-6
	77.96	80.46	15	1-284065-5
	72.92	75.42	14	1-284065-4
	67.84	70.34	13	1-284065-3
	62.72	65.22	12	1-284065-2
	57.68	60.18	11	1-284065-1
	52.6	55.1	10	1-284065-0
	47.48	49.98	9	284065-9
	42.44	44.94	8	284065-8
	37.36	39.86	7	284065-7
	32.24	34.74	6	284065-6
	27.2	29.7	5	284065-5
	22.16	24.66	4	284065-4
	17	19.5	3	284065-3
	12	14.5	2	284065-2
DIM "A"	DIM "B"	NO. OF POSITION	PART NUMBER	

THIS DRAWING IS A CONTROLLED DOCUMENT.

DIMENSIONS:	TOLERANCES UNLESS OTHERWISE SPECIFIED:	DWN	07MAR2008
mm	0 PLC ±	CHK	03JUL2008
	1 PLC ±0.3	APVD	03JUL2008
	2 PLC ±0.25	PRODUCT SPEC	
	3 PLC ±	APPLICATION SPEC	114-20079
	4 PLC ±	WEIGHT	-
	ANGLES ±2°	CUSTOMER DRAWING	
	FINISH	SCALE	5:1

STE TE Connectivity
 NAME: TERMINAL BLOCK, MULTIPLE HEADER.
 180 DEGREE, CLOSED ENDS,
 5.08mm PITCH
 SIZE: A2 CAGE CODE: 00779 DRAWING NO: C-284065 RESTRICTED TO: -
 SHEET 1 OF 4 REV D

REVISIONS				
P	LTR	DESCRIPTION	DATE	APVD
-		SEE SHEET 1	-	-

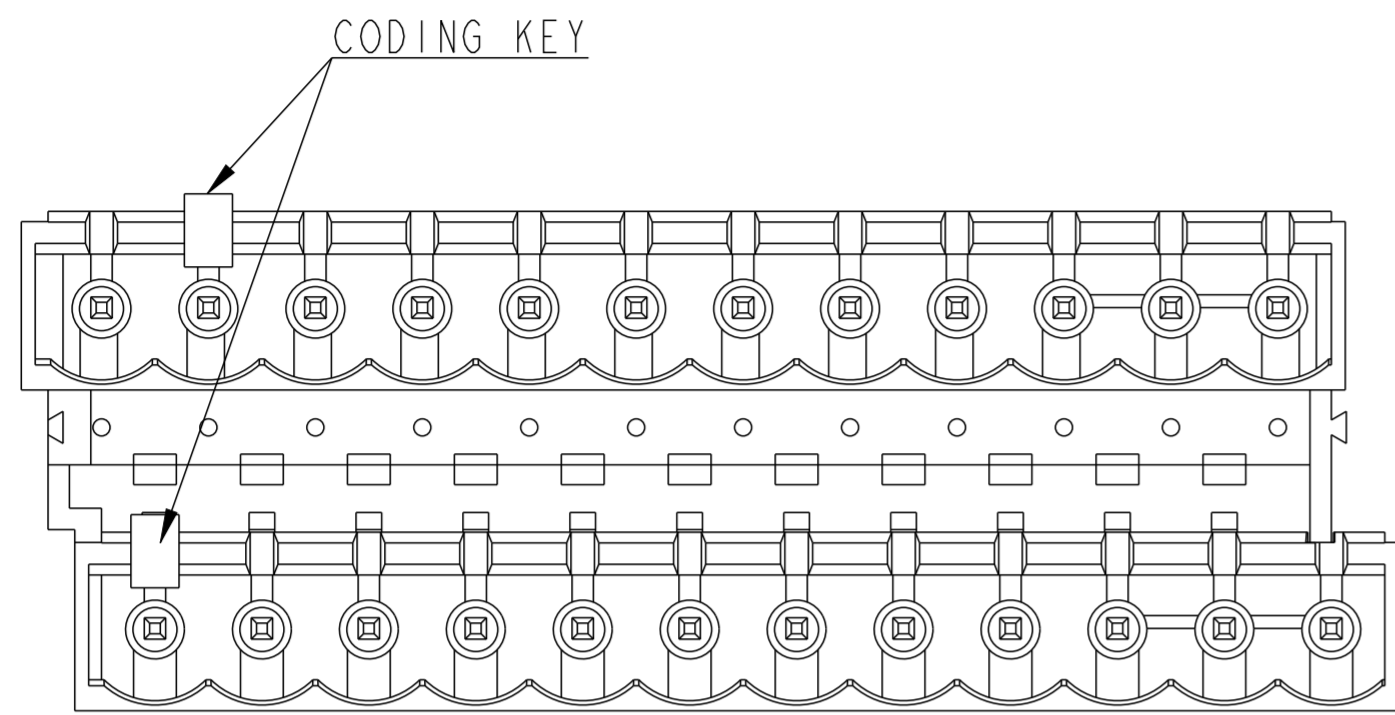

2-284065-6

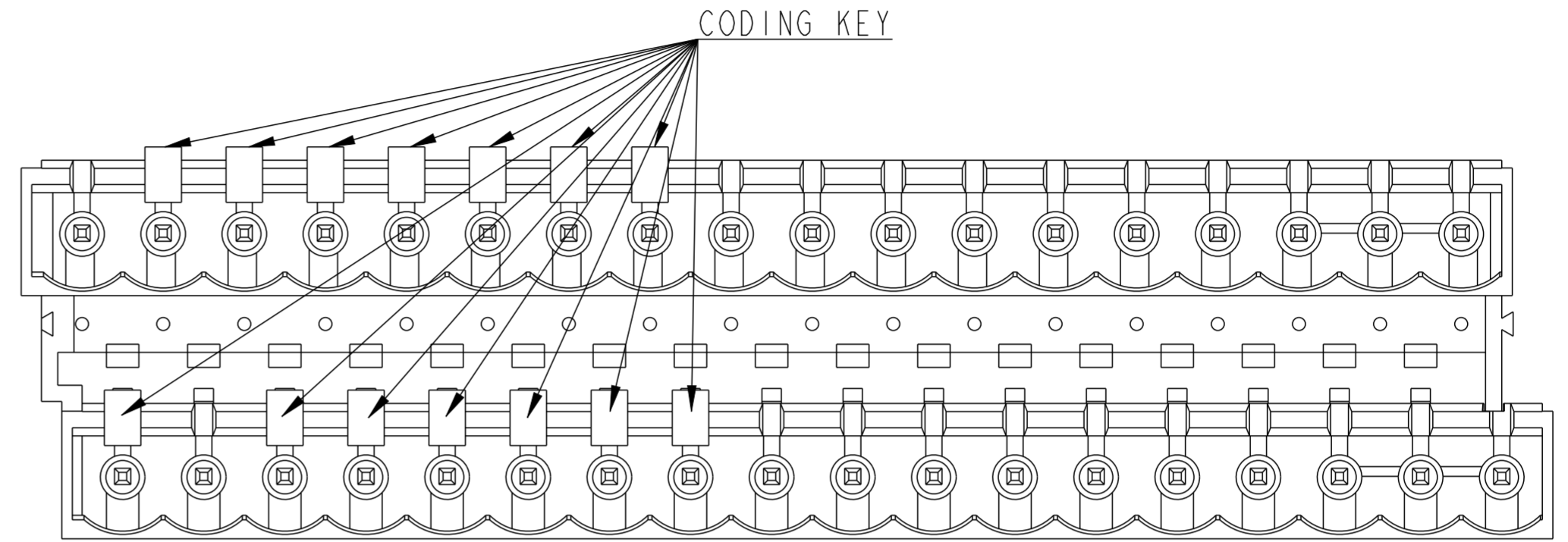

2-284065-9

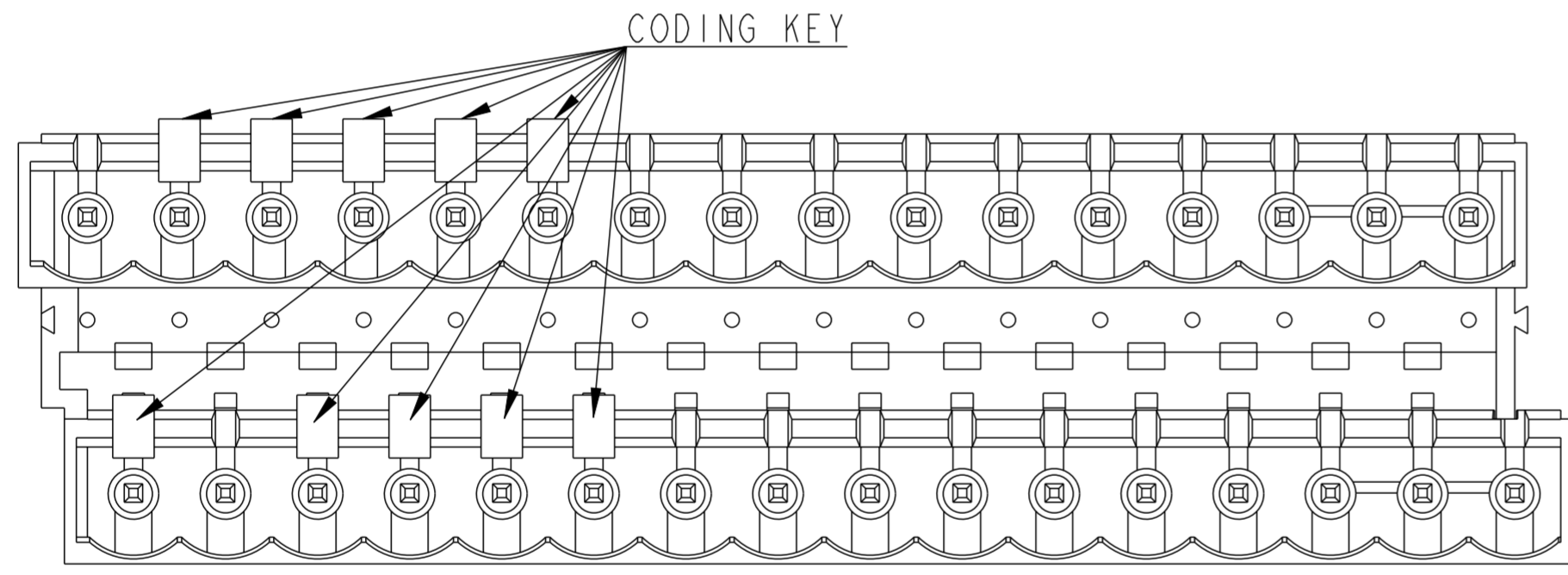

2-284065-7

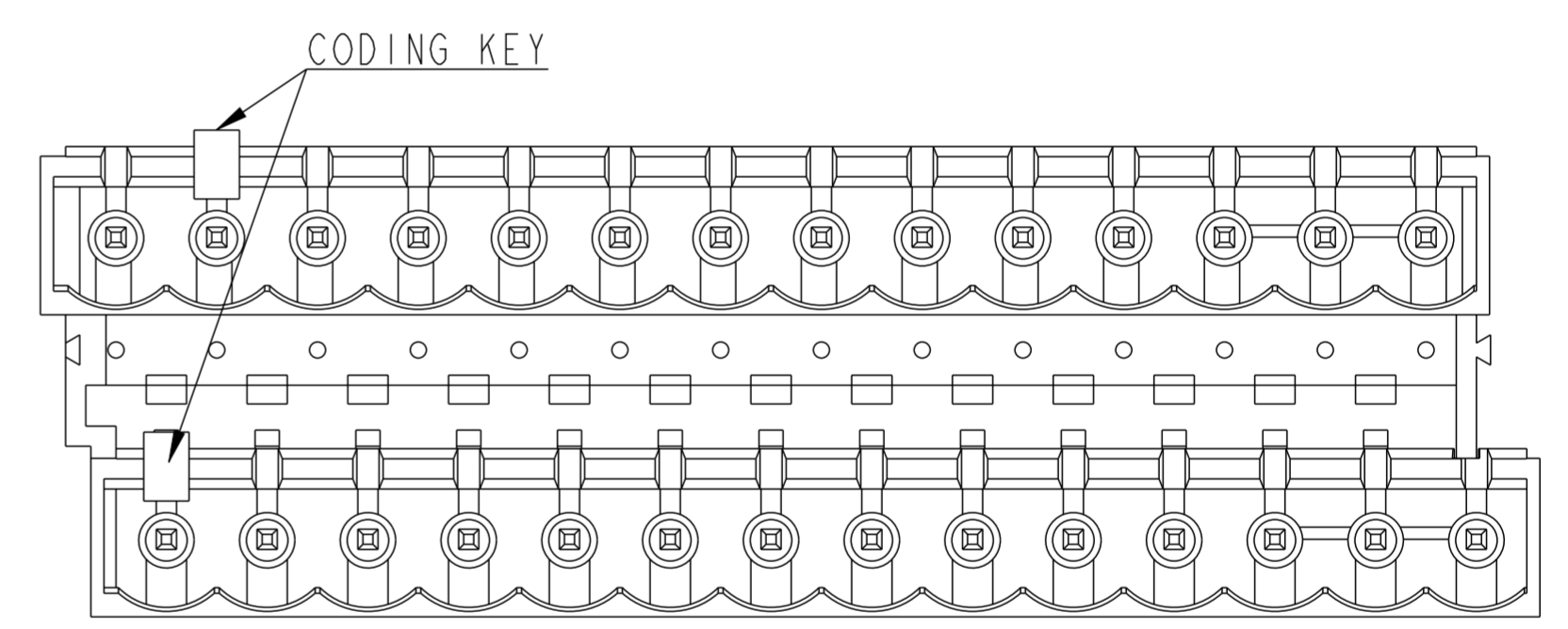

2-284065-8

THIS DRAWING IS A CONTROLLED DOCUMENT.		DWN S SCHLEGEL 07MAR2008		
		CHK C RICHARD 03JUL2008		
		APVD C RICHARD 03JUL2008	NAME TERMINAL BLOCK, MULTIPLE HEADER. 180 DEGREE, CLOSED ENDS, 5.08mm PITCH	
DIMENSIONS: mm		TOLERANCES UNLESS OTHERWISE SPECIFIED:		SIZE A2
		0 PLC ±-	1 PLC ±0.3	CAGE CODE 00779
		2 PLC ±0.25	3 PLC ±-	DRAWING NO C-284065
		4 PLC ±-	ANGLES ±2°	RESTRICTED TO -
MATERIAL		FINISH	APPLICATION SPEC 114-20079	SCALE 5:1
			WEIGHT -	SHEET 2 OF 4
			CUSTOMER DRAWING	REV D

P	LTR	DESCRIPTION	DATE	DWN	APVD
-		SEE SHEET 1	-	-	-

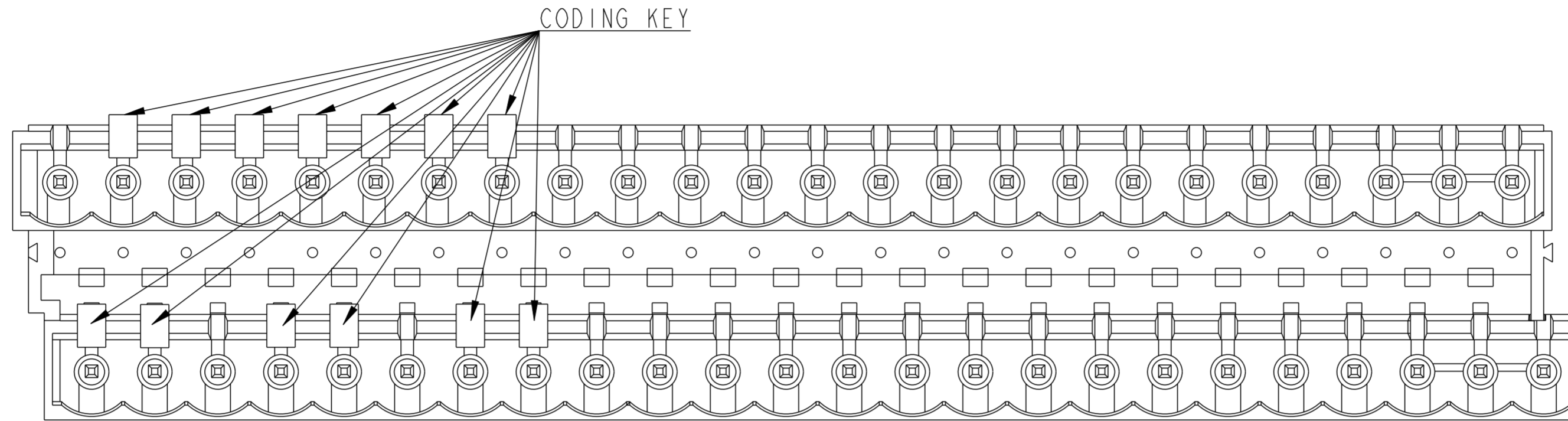

3-284065-0

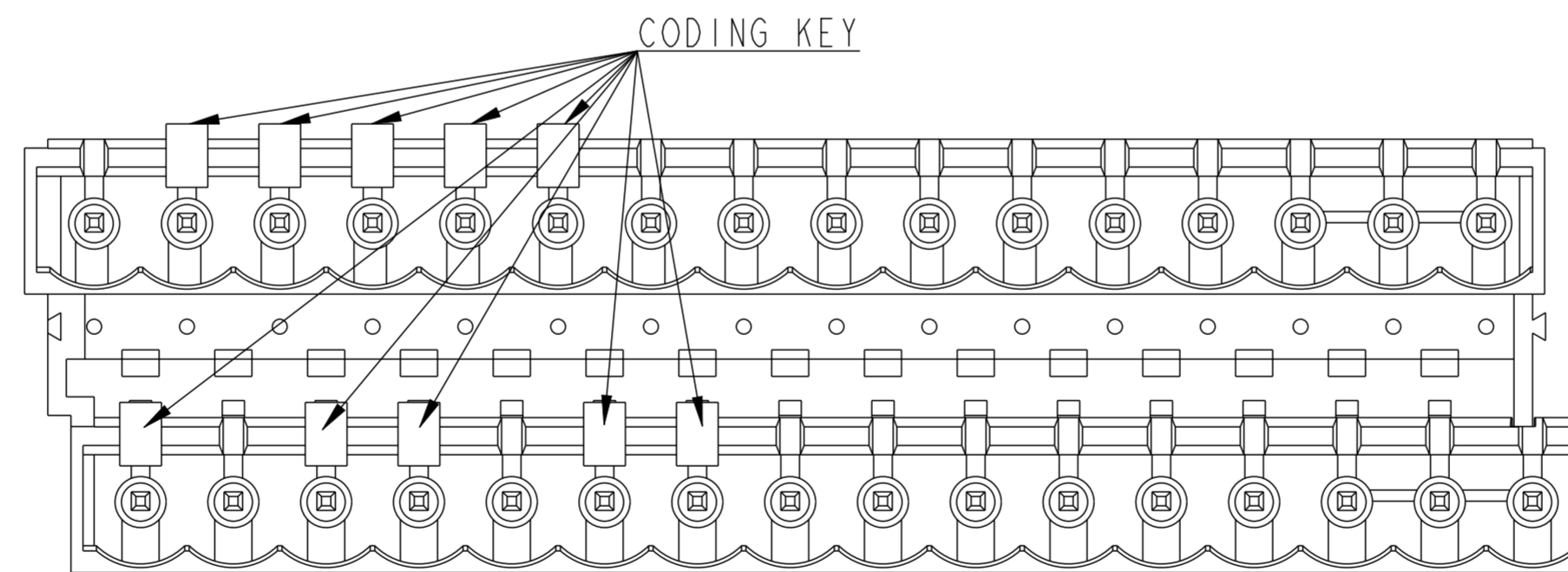

3-284065-1

THIS DRAWING IS A CONTROLLED DOCUMENT.		DWN S SCHLEGEL 07MAR2008	 TE Connectivity	
DIMENSIONS: mm		CHK C RICHARD 03JUL2008		
TOLERANCES UNLESS OTHERWISE SPECIFIED:		APVD C RICHARD 03JUL2008	NAME TERMINAL BLOCK, MULTIPLE HEADER. 180 DEGREE, CLOSED ENDS, 5.08mm PITCH	
0 PLC ±- 1 PLC ±0.3 2 PLC ±0.25 3 PLC ±- 4 PLC ±- ANGLES ±2° FINISH		PRODUCT SPEC -	SIZE A2	CAGE CODE 00779
MATERIAL		APPLICATION SPEC 114-20079	DRAWING NO C-284065	RESTRICTED TO -
		WEIGHT -	SCALE 5:1	SHEET 3 OF 4
		CUSTOMER DRAWING	REV D	

REVISIONS

P	LTR	DESCRIPTION	DATE	DWN	APVD
-		SEE SHEET 1	-	-	-

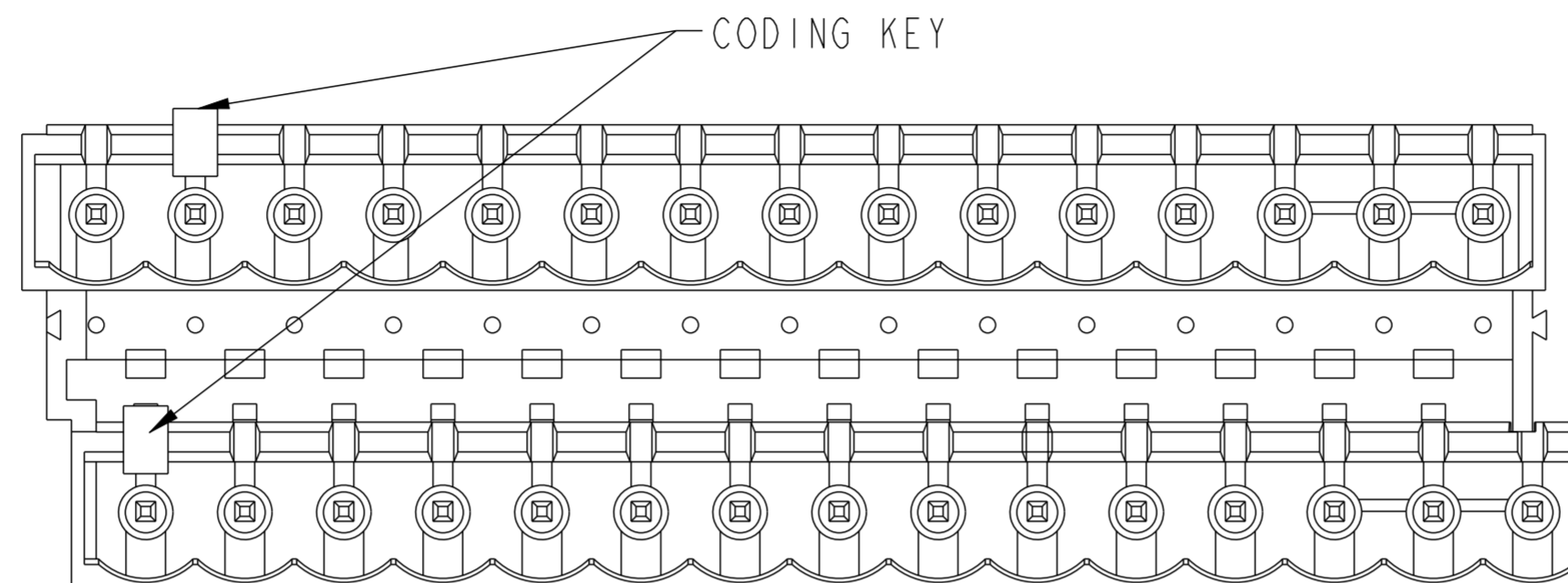

3-284065-2

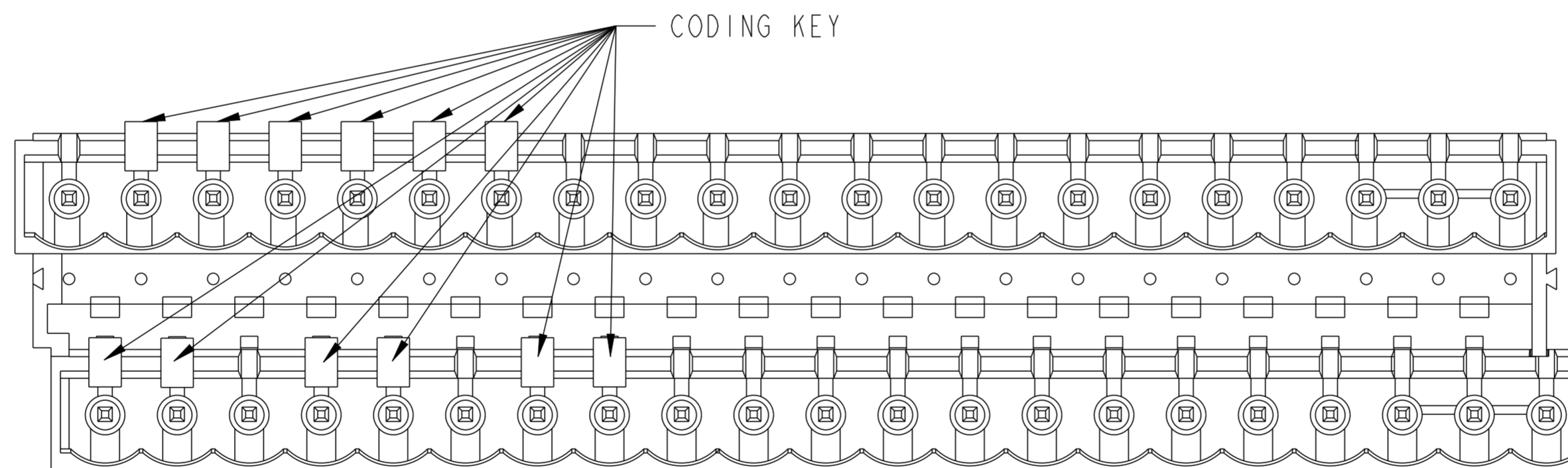

3-284065-3

THIS DRAWING IS A CONTROLLED DOCUMENT.		DWN S. SCHLEGEL 07MAR2008	 TE Connectivity	
DIMENSIONS: mm		CHK C. RICHARD 03JUL2008		
TOLERANCES UNLESS OTHERWISE SPECIFIED:		APVD C. RICHARD 03JUL2008	NAME TERMINAL BLOCK, MULTIPLE HEADER. 180 DEGREE, CLOSED ENDS, 5.08mm PITCH	
0 PLC ±- 1 PLC ±0.3 2 PLC ±0.25 3 PLC ±- 4 PLC ±- ANGLES ±2° FINISH		PRODUCT SPEC -	SIZE A2	CAGE CODE 00779
MATERIAL		APPLICATION SPEC 114-20079	DRAWING NO C-284065	RESTRICTED TO -
		WEIGHT -	SCALE 5:1	SHEET 4 OF 4
		CUSTOMER DRAWING	REV D	

X-ON Electronics

Largest Supplier of Electrical and Electronic Components

Click to view similar products for [Pluggable Terminal Blocks](#) category:

Click to view products by [TE Connectivity](#) manufacturer:

Other Similar products are found below :

[57.510.0053](#) [MC 1.5/ 6-ST-3.5 GY AU](#) [734-104](#) [734-302](#) [8-141-P](#) [8426620000](#) [860505](#) [860516](#) [860810](#) [GBPACX-12](#) [93.731.4953.0](#) [PV05-5,08-K](#) [PVP02-5,00](#) [PVP03-3,50](#) [PVP04-3,50](#) [PVS02-5,00](#) [1-1986160-3](#) [1377680000](#) [1531000000](#) [1546228-5](#) [ELFH16150](#) [ELFP03110](#) [ELFP10210](#) [ELFT06250](#) [ELVP03100](#) [1700101](#) [1700410](#) [1700425](#) [1702246](#) [1705229](#) [1710175](#) [1714537](#) [1717806](#) [1719600](#) [1728941](#) [1734692](#) [1734795](#) [1736036](#) [1740194](#) [1740291](#) [1740628](#) [1740990](#) [1746952](#) [1750207](#) [1752441](#) [1752865](#) [1754115](#) [1754144](#) [1756913](#) [1760051](#)